

# Enbridge

# Contractor Safety

# Specifications

---

## *Enbridge Gas Transmission and Midstream*

Approved By: **Safety & Reliability**

Document Number: **Version 2.1**

Issue Date: **July 12, 2023**

This material is protected by copyright and is the exclusive property of Enbridge. No external distribution or transmission of this material is permitted without the prior written consent of Enbridge. Applications for the copyright holder's written permission to reproduce any part of this publication should be addressed to the Manual Custodian.

Enbridge assumes no responsibility for errors or omissions in this document or for incidental or consequential damage that may result from the external use or duplication of this material.

## Version History

Version Number	Date	Revised By	Sections Affected	Description	Approved By
1.1	11/4/2019	Justin Seet	Version Page	Reviewed and approved for implementation	Sean Evans
2.0	6/23/2023	Ernesto Perez	Purpose, Scope and Expectations, Sections: 3.0 Hazard and Risk Management, 5.0 Administrative Controls Normal H&S,7.0 Administrative Controls – Abnormal 8.0 Contractor Safety Management, 14.0 Document Resources	Revised document as per GTM Safety Manual v.3 Changes Remove CAN references Edited headers and TOC	Greg Kelly and Rick Landry
2.1	7/12/2023		Section 5.0 Administrative Controls	Remove CAN references	Greg Kelly and Rick Landry

# Contents

Version History.....	2
Contents.....	3
1 Purpose, Scope, and Expectations.....	7
1.1 Purpose .....	7
1.2 Scope .....	7
1.3 Expectations .....	7
1.4 Safety Principles.....	8
1.5 Company Lifesaving Rules.....	9
2 Leadership and Governance .....	12
2.1 Contractor Management System.....	12
2.2 Leadership in Action .....	12
2.3 Stop Work Authority and Right to Refuse Unsafe Work .....	13
3 Hazard and Risk Management .....	14
3.1 Hazard Identification and Control .....	14
3.2 Energy Based Hazard Recognition .....	15
3.3 Job Hazard Analysis.....	16
3.4 Safe Work Permitting.....	17
3.5 Field Level Hazard Assessment.....	19
4 Legal Requirements.....	21
4.1 Occupational Health and Safety Regulations .....	21
4.2 Occupational Injury and Illness Management and Recordkeeping .....	21
5 Administrative Controls Normal – H&S.....	23
5.1 Abrasive Blasting.....	23
5.2 Aerial Work Platforms.....	25
5.3 All-Terrain and Off-Road Vehicles.....	26
5.4 Aviation Safety.....	28
5.5 Boom Truck and Rigging.....	34
5.6 Bonding and Grounding.....	36
5.7 Brush Cutting, Clearing and Vegetation Management .....	39
5.8 Compressed Gas Cylinders.....	41
5.9 Confined Space Entry.....	44
5.10 Crane and Hoist Safety .....	55

5.11	Critical and Serious Lifts .....	62
5.12	Electrical Safety .....	65
5.13	Excavation and Trenching Safety .....	68
5.14	Fall Protection.....	74
5.15	Fatigue Management.....	79
5.16	Flammable and Combustible Materials .....	80
5.17	General Equipment Safety .....	83
5.18	General Office Safety .....	84
5.19	Hand and Portable Power Tools.....	86
5.20	Hazardous / Restricted Areas and Portable / Personal Gas Monitors.....	96
5.21	Hot Work.....	106
5.22	Housekeeping.....	111
5.23	Hydrostatic and Pneumatic Testing .....	112
5.24	Ignition Sources.....	114
5.25	Isolating Line Breaks and Equipment Opening .....	116
5.26	Journey Management.....	119
5.27	Ladder Safety .....	120
5.28	Lockout Tagout.....	123
5.29	Machinery and Equipment Guarding .....	124
5.30	Manual Handling of Materials and Back Safety.....	127
5.31	Marine and Offshore Operations Safety .....	128
5.32	Material Handling and Storage .....	130
5.33	Mechanical Heavy Equipment Safety.....	132
5.34	Personal Protective Equipment (PPE).....	136
5.35	Pigging.....	152
5.36	Powered Industrial Truck.....	155
5.37	Public Work Area Traffic Management Guide .....	157
5.38	Respiratory Protection .....	160
5.39	Safe Handling of Pipeline Liquids.....	165
5.40	Safeguards, Barricades and Warning Signs (Temporary).....	166
5.41	Scaffolding.....	169
5.42	Severe Weather.....	174
5.43	Transportation of Hazardous Materials (US ONLY) .....	176

5.44	Vehicle Safety.....	181
5.45	Working Alone .....	186
	Walking and Working Surfaces .....	188
6	Administrative Controls – Industrial Hygiene .....	190
6.1	General Requirements .....	190
6.2	Asbestos Management.....	190
6.3	Bloodborne Pathogens .....	190
6.4	Hearing Loss Prevention .....	194
6.5	Hydrogen Sulfide .....	195
6.6	Lead Management.....	196
6.7	Naturally Occurring Radioactive Material (NORM).....	196
6.8	Heat Stress or Cold Stress .....	198
7	Administrative Controls – Abnormal .....	200
7.1	AED Emergency Response.....	200
7.2	Emergency Equipment Inspections .....	201
7.3	Emergency Eyewash and Shower Stations.....	204
7.4	Emergency Management .....	205
7.5	Fire Extinguishers.....	206
7.6	First Aid Preparedness .....	209
8	Contractor Safety Management.....	210
8.1	General Section.....	210
8.2	Subcontractor Safety Management .....	210
8.3	Contractor Safety Representatives.....	211
8.4	Incident Reporting and Investigation .....	212
8.5	Site Safety Management Processes .....	212
9	Management of Change .....	214
9.1	General Section.....	214
10	Training and Competency .....	214
10.1	Competency Assurance .....	214
10.2	Health and Safety Training .....	216
10.3	Health and Safety Orientations.....	216
10.4	Safety Observation Program .....	216
11	Documents and Records Management.....	217

11.1	Document Control.....	217
11.2	Records Management .....	217
12	Health and Safety Assurance.....	219
12.1	Incident Reporting, Investigation and Learning .....	219
12.2	Internal Health and Safety Inspections.....	220
12.3	General Facility Safety Inspection .....	220
12.4	Management of OSHA Regulatory Inspections.....	221
12.5	Internal Self-Assessments.....	222
12.6	Corrective and Preventive Action .....	222
13	Stakeholder Engagement.....	222
13.1	Internal Communications.....	222
13.2	Post Incident Leadership Review .....	223
14	Document Resources.....	224
14.1	Acronyms.....	224
14.2	Definitions.....	227
14.3	List of Tables .....	241
14.4	List of Figures.....	242

# 1 Purpose, Scope, and Expectations

## 1.1 Purpose

This Company Contractor Safety Specification documents the minimum safety requirements to which Workers shall adhere. The requirements shall:

- Meet or exceed applicable occupational H&S requirements for the jurisdictions where Company operates.
- Help establish safe work behaviors.

Specific terms are used to indicate whether an action is mandatory or recommended. The following words have specific meanings:

- “Shall” is used where an action is mandatory.
- “Should” is used where an action is recommended.
- “May” is used where alternatives are equally acceptable.

Acronyms and definitions are found at the end of this Specification (in *Section 13*). Definitions are bolded, italicized and in a darker font throughout this Manual.

## 1.2 Scope

These Specifications apply to all Contractors engaged in design, construction, operation, gathering, processing, storage, maintenance, decommission and abandonment activities at Company facilities, as well as visitors to these worksites.

## 1.3 Expectations

Contractors and visitors must carry out their individual responsibilities to provide a safe and healthful work environment. Everyone must therefore become familiar with these Specifications with respect to their work duties.

---

## 1.4 Safety Principles



# Our Path to Zero

### SAFETY PRINCIPLES AT ENBRIDGE OUR COMMITMENT

Enbridge is committed to ensuring everyone returns home safely at the end of each and every day, and that our assets are operated in a safe and reliable manner. We base our commitment to safety on our care for employees, contractors, the communities in which we operate and the environment.

Our values of Integrity, Safety and Respect guide our decisions, actions and interactions individually and as a company. Our Safety Principles support our values and highlight the fundamental beliefs we share on our path to a zero-incident workplace.

Safety. It's a core value that makes us Enbridge. It's our way of life.

### SAFETY PRINCIPLES OUR PATH TO ZERO

#### 1. All injuries, incidents, and occupational illnesses can be prevented.

Enbridge is committed to protecting the health and safety of our employees, our contractors and the public. Our goal is zero injuries, incidents and occupational illnesses. Striving for anything less can lead to the false belief that injuries, incidents and occupational illnesses are inevitable and acceptable. In every instance, protecting the health and safety of workers and the public requires strict adherence to company policies and procedures, including Enbridge's Lifesaving Rules.

#### 2. All operating exposures can be controlled.

Enbridge believes that all operating exposures and uncontrolled releases that may result in injury, illness or environmental damage can be prevented. Through the rigorous application of process safety requirements we strive to eliminate hazards and minimize risks by implementing effective safeguards. When it is not possible or practical to completely eliminate hazards, we implement engineering controls such as fail-safe control systems, warning and detection devices, and automatic safety devices to reduce the risk. Administrative controls and/or personal protective equipment serve as the last line of defense against the hazards we face.

#### 3. Leaders are accountable for safety performance.

People leaders are accountable for safe operations and the safety and health of the workers under their care. This includes accountability for establishing and maintaining a safe work environment through the application of our Management System. As well, it includes establishing, regularly reviewing and updating policies and procedures using disciplined change management, providing the proper equipment, completing appropriate training, correcting deficiencies promptly, and ensuring approved procedures are followed.

#### 4. All employees/contractors are responsible for safety.

People are the most important element of our health and safety program and ensuring our operational reliability. Enbridge expects employees and contractors to take personal accountability for their safety, that of their co-workers and the general public, and the safe operations of our assets. Further, workers have not only a right but a duty to stop and/or refuse work they feel is unsafe. Our success depends on all levels and all members of the organization being committed and accountable for consistently adhering to our company policies and procedures as well as all applicable regulations, codes and standards. Working safely is a condition of employment.

#### 5. Assessment and improvement are a must.

Enbridge is committed to continuously improving our safety performance through field and operational assessments, and diligent application of quality and safety assurance practices and processes. Further, we employ disciplined root cause analysis and thoughtful exploration of human factors during incident investigations to identify and learn from weaknesses in our safety systems. We promptly address deficiencies revealed through these activities, and communicate what we learn across the organization to strengthen our systems and make Enbridge even safer.

#### 6. We promote off-the-job health and safety for our employees 24/7.

Our concern for the safety and health of employees extends beyond the workplace. An off-the-job injury is as painful and impactful as one suffered on the job. We encourage our employees to demonstrate their leadership and excellence in health and safety practices for the benefit of their families, friends and community. An engaged workforce is a key building block of a healthy safety culture.

We strive to create a vigilant and resilient safety culture, in which all members of our team keep themselves and others safe, leaders care for the health and safety of their people, and we learn from safety failures to prevent future incidents. Our Safety Principles are foundational to our safety culture and our long-term success as an organization.



Al Monaco, President and CEO  
December 1, 2017



## 1.5 Company Lifesaving Rules

The Company values the safety of our communities, customers, Contractors, and Employees, and believes that all injuries are preventable. Compliance with all policies, procedures and regulations is a requirement. Lifesaving Rules are a key focus area designed to protect Employees and Contractors and save lives.

The Lifesaving Rules apply to everyone, and compliance is mandatory. Contractors who choose not to follow the Lifesaving Rules are choosing not to work on any Company project or Company site.



**Figure 1: Lifesaving Rules**

### Lifesaving Rules

1. **Hazard Management** – I will complete a hazard assessment prior to starting work and reassess if conditions change and new hazards are introduced.
2. **Driving Safety** – I will only operate a motor vehicle or mobile equipment when free of adverse effects of alcohol or any substance that causes impairment.
3. **Confined Space Entry** – I will confirm the atmosphere has been tested, is monitored and a plan in place prior to entering a confined space.
4. **Ground Disturbance** – I will verify the location of buried utilities through surface locating and positive identification prior to conducting a mechanical excavation.
5. **Isolation of Energized Systems** – I will verify isolation before work begins on energized or pressurized systems (Lockout/Tagout).
6. **Reporting of Safety Related Incidents** – I will immediately report significant safety related incidents.
7. **Bypassing Safety Controls** – I will obtain authorization before overriding or disabling safety-critical equipment or controls.

### **“Safety-Critical Equipment and Controls”:**

We define safety-critical equipment and controls as those physical devices or systems that if overridden, disabled, or bypassed could result in serious injury, loss of life, and / or significant damage to property and / or the environment. Examples of safety-critical equipment and controls may include, but are not limited to:

- isolation devices
- emergency shut down valves
- Lockout / Tagout devices
- trip systems
- relief valves
- fire and gas alarm systems
- certain level controls
- alarms and detection devices
- crane limit switches
- in-vehicle monitoring systems
- markings/devices that define safe limits of approach (EG: Powerline crossing goalposts/barriers, etc.)

Bypassing Safety Critical Elements based on an approved and published procedure or standard does not need special authorization. However, required approvals and notifications within the procedure or standard shall be adhered to and will follow the relevant business process.

In all other cases, authorization must be obtained before safety-critical equipment or controls are bypassed, and this authorization must come from the appropriate leadership level and applicable functional areas, in keeping with approved procedures for the work being planned and the safety-critical equipment or controls being bypassed.

### **Requirements**

- The Lifesaving Rules are about safety, not discipline. Contractor’s first course of action whenever they believe that a Lifesaving Rule has been broken is the completion of a thorough investigation. This is in keeping with Company values of Integrity, Safety and Respect and with the Company’s desire to create a just safety culture in which we can learn from our mistakes.
- After the Contractor conducts an investigation, what discipline, if any, is appropriate will be determined. As with any violation of Company policy or procedure, termination is and must be a potential disciplinary outcome.
- Contractor adherence to the Lifesaving Rules is critical. The rules help protect all members of our team from injury or worse. They are a key part of meeting Company’s commitment that everyone returns home safe at the end of every day and that our assets are operated safely.
- Contractors should know and comply with the Lifesaving Rules, exercise their authority and obligation to stop unsafe work, and ensure that they report unsafe practices and situations so that Company can investigate them, identify the root causes, and learn.

- Company Lifesaving Rules training for Contractors is provided through project orientations as a part of project onboarding.

## 2 Leadership and Governance

### 2.1 Contractor Management System

Contractors shall have a management system structure that provides all Contractor Workers with the elements, expectations, and performance measures to effectively implement their H&S Program supported by their Project Specific Safety Plan to meet the minimum requirements set out in these Contractor Safety Specifications.

Contractor shall comply with Company H&S requirements set out in these Specifications. If a Contractor has an H&S standard or policy that is materially different from the Company's, the Contractor shall follow the most stringent requirement between the two programs. When a specific form is noted in this manual, Contractors may utilize that form or an equivalent approved contractor form where applicable.

**Contractors Management System shall contain (at a minimum):**

- Management Oversight
- Hazard identification, Risk Assessment and Control
- Health and Safety Procedures
- Emergency Preparedness
- Incident reporting, investigation, and learning
- Sub-contractor safety management
- Contractor project site and equipment inspections
- Worker competency assurance
- Worker Health and Safety training
- Safety meetings
- Audits and assessments
- Program Review Cycle

---

### 2.2 Leadership in Action

Contractor and Subcontractor Leadership shall be engaged in the promotion of safety at worksites. It is expected that Contractor Management is actively involved by regularly visiting the site, conducting documented safety audits, participating in safety meetings, and attending Safety Stand-down events.

Measurement activities shall be developed and included in the Contractor documents for performance review between the Contractor and the Company.

## 2.3 Stop Work Authority and Right to Refuse Unsafe Work

### Contractor shall have a policy that establishes the expectation that:

- All Workers have the right to refuse work when they believe it is dangerous to the health and safety of themselves or to any person at a Company Worksite.
- Workers have the authority to stop any work that they believe presents an imminent threat to the life or health of a Worker or other person exposed to a hazard, condition, or activity.
- All refusals of unsafe work shall be investigated and addressed with the Worker before the work resumes.
  - If unsafe work conditions, activities or hazards are identified during the investigation, corrective measures must be implemented to resolve the conditions, activities, or hazards before the work resumes.
- Workers have the right to know about the hazards associated with their work and to participate in the mitigation of the hazards.
- Any form of retaliation against a Worker who in good faith refuses unsafe work is prohibited.

### Stop Work Authority Steps (as illustrated in Figure 2)

1. Stop the unsafe or dangerous work
2. Initiate the stop work process
3. Work with co-workers and Supervisor to identify the controls necessary to mitigate the hazard
4. Implement the hazard controls
5. Resume the work

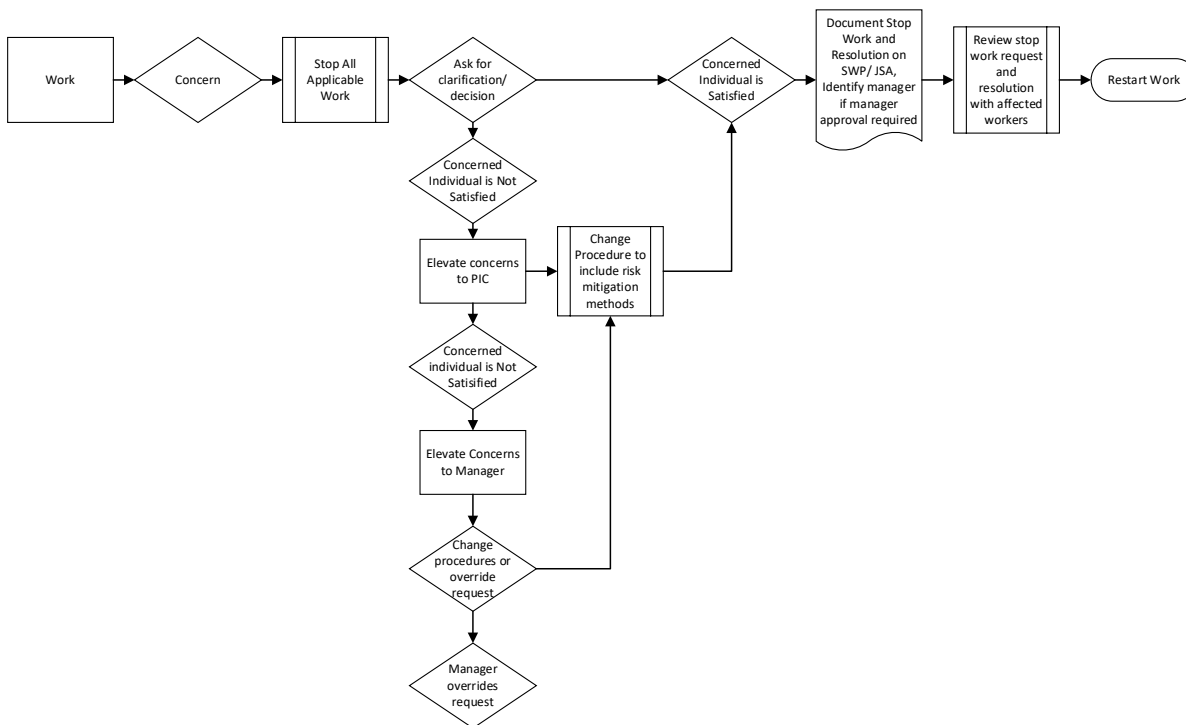

Figure 2: Stop Work Authority

## 3 Hazard and Risk Management

### 3.1 Hazard Identification and Control

The following sections describe the hazard identification activities used by all Workers to systematically identify, control, or eliminate hazards, potential or imminent hazards. Contractors and Workers can prevent hazards from causing harm when they:

- Eliminate the hazard
- Reduce the hazard, including substitution or isolation
- Engineer solutions to mitigate the hazard
- Use administrative controls such as procedures or applying training, or
- Wear personal protective equipment

#### **Contractors shall ensure that:**

- Workers are trained:
  - To identify, assess and control known, foreseeable and potential hazards.
  - To document the hazards and describe the controls used to prevent the hazard from causing harm.
- Hazard assessments of work activities and worksites are completed as required.
- Everyone involved in a work activity participates at some stage in the hazard assessment for that work.
- The results of the assessment shall be communicated to all other Workers who may be affected by the work.
- The training provided on hazard assessment is effective and sufficient.
- Documented hazard assessments are retained.
- Through periodic review, that all Workers are adequately trained in the hazard assessment and control processes.
- Ensure that FLHAs, JHAs and Safe Work Permits are accurately identifying known and potential hazards.
- Assess work-in-progress to ensure that the processes are adequate to assess the hazards, and the controls implemented have reduced the risk associated with the work to As Low As Reasonably Achievable (ALARA) levels.
- Workers are:
  - Capable of executing their responsibilities in the Hazard Assessment and Control Process.
  - Actively participating in the applicable Hazard Assessment and Control Process and ensuring that an appropriate level of assessment is completed before the start of the work.
  - Ensuring all workers involved in the work participate in the hazard assessment process.

- Communicating the results to all Workers in the area who may be affected by the work.
- Hazard assessments are documented for all work activities other than the below exceptions:
  - Office related work (e.g., computer use, training, meetings)
  - Travel between work locations
  - Housekeeping duties

These exceptions do not take away a worker's responsibility to assess the hazards in their work environment. Workers shall continue to practice cognitive hazard assessment techniques (e.g., stop, look, assess, and manage).

### 3.2 Energy Based Hazard Recognition

Company has adopted the Energy Based Hazard Recognition (see Figure 3) as its main hazard recognition methodology.

This wheel is representative of the various forms of energy that pose potential to cause harm to people, property, or assets.

- The energy wheel is used as a hazard recognition aid when conducting hazard assessments.
- The hazard recognition methodology has identified ten energy sources.

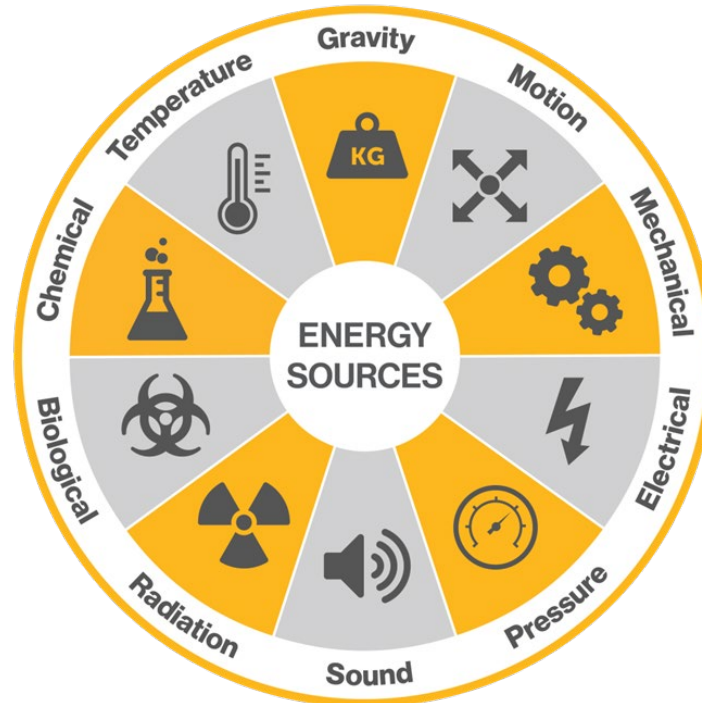

**Figure 3: Energy Based Hazard Recognition Graphic**

### 3.3 Job Hazard Analysis

Contractor shall have a Job Hazard Analysis (JHA) process to systematically identify, control, or eliminate potential or actual hazards associated with a job task, as part of the larger hazard identification, assessment, and control requirements.

This section applies to all Contractors involved construction, operations, maintenance, abandonment, or emergency situations.

The JHA process may be used at any time to assess the hazards of any job. The jobs which benefit most from this systematic hazard identification and control process include:

- Jobs where an incident, hazardous condition, or exposure to harmful substances could cause serious injury, environmental and/or property damage.
- Jobs where the potential exists for severe injuries or illnesses (consequences of an accident, hazardous condition, or exposure to harmful substances are potentially severe).

The JHA process is mandatory prior to certain types of work and should be considered when planning work.

**NOTE:** Typically, the JHA is completed in advance by the Contractor. However, there may be scenarios where Enbridge may provide a JHA (to be subsequently reviewed by the Contractor) or the JHA is completed as part of the FLHA or the FLHA used in lieu of the JHA for low-risk work activities at the discretion of the Enbridge representative.

#### Contractors shall:

- Create, review, or revise a JHA for all work being performed with the exception of:
  - General Light Housekeeping
  - Building and Lawn Maintenance
  - Fleet Vehicle Care & Maintenance
  - General Tool Repairs and Maintenance
  - Facility Inspections and Monitoring
  - Line Locating Activities
  - Any Low-Risk Activities Determined at the company Discretion
  - Contractor work is delivery or service (equipment service personnel, telephone, computer, etc.).
- Have JHAs authorized by the Safe Work Permit Issuer and/or Person in Charge (PIC) / Enbridge Authorized Representative or Designate
- The JHA document utilized by Contractors can be either an Enbridge document or an equivalent approved Supplier form
- Upon completion of the job, return JHAs to appropriate Person in Charge (PIC) / Enbridge Authorized Representative or Designate or administrator for filing



### Additional JHA Requirements:

- A JHA must identify any imminent hazards or elevated risk exposures (including those that exist even after the application of mitigative controls). This requirement applies to construction, operations, maintenance, abandonment, and emergency situations conducting the following types of work:
  - Any non-routine jobs that pose elevated hazards or risk of injury such as, but not limited to, changing out mole sieve, changing out large equipment, hot work in a hazardous area, etc.
  - Large jobs that involve multi-work teams and/or multi-suppliers such as, but not limited to, turn arounds, shutdowns, construction in an operating facility, etc.
  - Routine, non-routine jobs, and abnormal operating conditions that pose elevated hazards or risk of:
- High risk work may require additional levels of approval before proceeding.
  - This determinization may be captured in the scope of work, the JHA or by the Enbridge PIC
- Where it is determined that despite the hazard and risk mitigation strategies captured on the JHA and any other work instructions, an unacceptable residual risk of an Abnormal Event remains, the Contractor shall work with an authorized Enbridge representative to trigger the creation and approval of a documented Contingency Plan as per the Contingency Plan Development Process.

## 3.4 Safe Work Permitting

The purpose of the Safe Work Permitting section is to ensure that Enbridge workforce and Contractors use a consistent approach for authorizing work using the Safe Work Permit and/or Work Authorization Process. Safe Work Permit's ensure there is a conversation between the Person in Charge of the Enbridge work area and any worker(s) performing work in the area so that:

- The Hazards presented by the operation do not harm the worker(s)
- The work performed by the worker(s) does not harm the operation; and
- Both the SWP / Person in Charge of the operational area and the workers are clear:
  - What work is authorized.
  - When work is authorized to begin and when it must end.
  - Where (and on what equipment) the work is to be conducted; and
  - Any conditions and restrictions under which the work must be conducted

Contractors working in administrative areas or areas designated as non-operational areas by area management are not subject to the Safe Work Permit process.

Permits are not required for light housekeeping unless additional hazards are present that would normally require permitting.

A Safe Work Permit is only valid for the time stated on the permit.

**As the Safe Work Permit Receiver, the Contractor shall:**

- Provide the Permit Issuer with the information they require related to scope of work, the nature of the work and any potential hazards introduced to the work location by the work itself.
  - In certain cases, the Permit Receiver may be required to provide work planning for hazard assessment documents, like a JHA as a precondition to permitting.
- Review and agree to the conditions of the Safe Work Permit (as indicated by a signature on the permit).
- Communicate the requirements of the permit to all Workers involved in the work.
- Conduct any type of hazard assessment exercise stipulated by the Permit Issuer.
  - In certain cases, this may involve some form of JHA and/or FLHA.
- Ensure the permit requirements are fulfilled.
- Confirm understanding of deviations on mitigations and whether or not this requires reporting to a regulator prior to starting work.
- Keep a copy of the permit available at the work location.
- Stop or suspends work and communicates immediately with the Permit Issuer and/or the PIC if the scope of work or conditions change, or any other stipulation set out by the Permit Issuer for suspending work.
- Leave the work location in a safe condition prior to closing the Permit.
- Close out the permit with the Permit Issuer.

If during verification activities an isolation point has been incorrectly identified physically tagged or labeled, any work taking place shall be temporarily stopped until a resolution can be implemented.

When provided with a Safe Work Permit, the expectation is that the Contractor shall follow the requirements specifically identified on the appropriate Safe Work Permit and that in executing permitted work, the Contractor shall:

- Comply with Enbridge health and safety requirements set out in this Manual, as articulated within applicable Construction Safety Manual or Contractor Specifications.
  - If a Supplier or their subcontractor has a health and safety requirement or policy materially different from Enbridge's, the Supplier/subcontractor shall follow the most stringent requirement. Supplier and subcontractors are still obligated to meet the requirements of all applicable laws related to the Safe Work Permitting section of the H&S Manual.

In the event a Suppliers or subcontractor's requirements exceed the requirements of this H&S Manual, Enbridge may, in its sole discretion, choose to adopt the Suppliers or subcontractor's requirements for any given contract or work order. Mobile contractor crews hired to perform specific jobs over a span of ROWs or at multiple facilities without direct oversight by an Enbridge Representative may be "permitted" in accordance with Asset Area practices to manage this type of work. (e.g., pig trackers, cathodic protection survey crews, vegetation control crews, etc.)

*During Offshore Operations:*

- The arrival of a second Worker onsite to conduct work is considered a change of scope and the Safe Work Permit process must be implemented.
- Crews such as these may be issued with a Safe Work Permit at the originating location of the work for a maximum of five days provided that:
  - A frequency of contact is established, implemented, and documented on the permit.
  - A JHA is completed at the beginning of each day or shift and updated as required.

*Other Company Issued Permits:*

- UST and US Projects issue the following permit types:
  - Asbestos Work Permit
  - Permit Required Confined Space Entry
  - Energized Electrical Work Permit
  - Hot Work Permit

### 3.5 Field Level Hazard Assessment

A Field Level Hazard Assessment (FLHA) is a documented hazard assessment exercise that assists Workers in identifying and controlling worksite hazards immediately prior to starting work, hazards not anticipated by the JHA or Safe Work Permit and controls for those hazards.

If the work does not involve completing a JHA or Safe Work Permit, the FLHA provides an opportunity for a pre-job hazard assessment and control exercise.

The Field Level Hazard Assessment (FLHA) must be completed and/or reviewed by all workers involved in the hands-on work or may be affected by the work for a given job and acknowledge they understand the hazards and controls. The FLHA can be included in tailgate meetings.

There are several forms that may be used to complete the FLHA process including:

- FLHA forms or cards provided by Enbridge, or
- A Contractor form, if:
  - It provides a pre-job “stop and think” and triggers situation awareness prior to work beginning
  - There is a means of documenting that all Workers involved have participated in the FLHA prior to engaging in the work or
  - It is completed at the worksite itself where potential hazards can be visually spotted
  - Identifies the name and contact information of the PIC for the job
  - Identifies the SWP and/or WA number if applicable

#### **Contractors shall ensure that:**

- The applicable FLHA procedure is used within their respective areas of responsibility
- Applicable training is completed for Workers conducting the FLHA process
- Communicate the requirement for an FLHA process as part of pre-job planning or safe work permitting requirements. Particularly, the Contractor site supervision should reinforce:
  - The requirement to physically walk down or be at the worksite for the FLHA

- The need for all Workers involved in the job to participate in the FLHA
- Verify, as applicable and when possible, during work-in-progress, that FLHA requirements have been met and controls documented on the FLHA are appropriate and implemented.

**Contractors shall ensure that Workers:**

- Actively participate in the FLHA process
- Complete all sections on the FLHA
- Ensure the Enbridge Representative Person in Charge (PIC) has been identified on the FLHA
- Ask questions about any concerns related to the work or hazards as part of the FLHA process
- Not begin work or stop work if:
  - A hazard or imminent hazard is identified, or a condition arises that requires further input from the Person in Charge (PIC) / Enbridge Authorized Representative or Designator to assess and/or remedy.
  - Controls identified in the pre-job planning documents, safe work permit or FLHA are not implemented.
- Follow any requirements documented on the FLHA

### 3.6 Hazard Communication Program (HazCom)

**Contractor shall ensure that:**

- Have a written hazard communication program that meets the Hazard Communication Standard (HCS).
- Maintain a Hazardous Chemical Inventory in a location readily accessible to all workers and or visitors.
- Maintain a copy of SDSs for chemical products brought on site by Contractor for the duration of the service being provided or activities being performed.
- Provide a SDS for any chemical product that will be utilized on Company site for approval. The SDS will be evaluated to determine if the product's listed constituents will have health effects that can affect workers and/or affect the environment (i.e., air, soil, or water) adversely.
- Provide access to SDSs for all hazardous chemicals used or stored there must be available for quick reference at each work location where Workers report for work assignments.
- Workers have been provided with hazard communication training.
- Review Contractor and Sub-Contractor work to determine what hazardous chemicals may be encountered by the workers.
- Assess the method of control to ensure that OSHA PELs are not exceeded. Obtain and maintain SDS for all the hazardous chemicals currently being used in their workplace.
- PPE is provided as necessary to workers working with hazardous chemicals.
- Chemical containers on Company property are properly labeled.
- All hazardous chemicals used and stored in the workplace are properly labeled or marked.
- Labels, markings, and other forms of warning are:
  - Legible

- o In English
  - o Prominently displayed on the container
- All hazardous chemicals delivered to a worksite from a manufacturer or distributor must be in its primary containers with proper labeling.
- Reject and return unlabeled or incompletely labeled chemicals to the supplier.
- Each label includes the following:
  - o Product identifier
  - o Signal word
  - o Pictogram
  - o Hazard statement(s)
  - o Precautionary statement(s)
  - o Name, address, and telephone number (of the chemical manufacturer, importer, or other responsible party)
  - o Supplemental information

#### **Additional Instructional Pictograms**

- National Fire Protection Association (NFPA) 704 Diamond and American Coating Association (ACA) Hazardous Materials Identification System (HMIS) Rating System.
  - o The use of these systems is not consistent with the Classification and Hazard Category systems of the Revised Hazard Communication Standard but can be included on the workplace labels if the difference is explained to workers.

#### **Contractors shall ensure that Workers:**

- Use appropriate PPE provided for working with hazardous chemicals.
- Review SDSs for chemicals used in job tasks.
- Personal hygiene – Worker is responsible to wash exposed skin promptly to remove accidental splashes of hazardous material.
- Discontinue activity after any unexpected encounter with hazardous chemicals and report the incident.
- Review the SDS before using a chemical for the first time.

## **4 Legal Requirements**

### **4.1 Occupational Health and Safety Regulations**

Contractor shall comply with the following as applicable:

- Occupational Health and Safety Administration, Code of Federal Regulations 1910 & 1926
- Applicable State OSHA Plans

### **4.2 Occupational Injury and Illness Management and Recordkeeping**

Contractor shall establish process for the management, tracking and recording of occupational injuries and illnesses.

**Contractor policy shall require that:**

- Prompt and proper first aid or medical treatment must be administered to all work-related injuries and illnesses.
- All work-related injuries/illnesses are reported to Company.
- Appropriate Contractor Representative shall accompany an injured Worker to the physician to determine the extent of the injury and whether time off will be necessary.
- Ensure all incidents, and near misses (incident without loss-Near miss) are investigated.
- Notify OSHA, if incident meets OSHA reporting criteria.

**Contractor policy shall establish:**

- Late reporting requirements when a Worker becomes aware of an injury (e.g., foreign body in eye) after the workday has been completed.
- Procedure when Workers return to work from loss workdays.
- Procedure if a fatality occurs to include reporting to OSHA and the Company.

## 5 Administrative Controls Normal – H&S

### 5.1 Abrasive Blasting

#### **Contractors shall ensure that:**

- The site is prepared and controls are in place to prevent injury, illness or damage from the abrasive blasting.
- Site Preparation and Work Control shall include:
  - post warning signs within 15m (50 ft.) of the work area
  - where the abrasive blasting will affect other Workers, erect barricades, or rope off area to warn Workers and prevent access to work area
  - only Workers equipped with the required PPE shall enter the work area
  - Workers not directly involved in the abrasive blasting operation shall stay up-wind whenever possible
  - conduct initial and continuous Atmospheric Monitoring in Hazardous and Restricted areas
  - equipment and vehicles should be protected from debris projected from the work area
  - do not allow abrasive blasting within 3 m (10 ft.) of any tank vent whether the vents are open, unless the tank has been cleaned and declared gas free by a Qualified Worker; if a tank has not been cleaned and declared gas free, clean areas within 3 m (10 ft.) of tank vents with hand tools such as scrapers, wire brushes and similar equipment
- Workers are trained and qualified to perform their assigned tasks, duties, and responsibilities. This includes but is not limited to the Operator, the Attendant, and the Safety Watch.
- Inspect equipment daily before use, including testing of safety shutdown and control (deadman) switches. Inspection details shall be documented. Safety shutdown and control (deadman) switches shall not be disabled for any reason.
- Workers wear additional PPE as required by the Hazard Assessment to protect against exposure to high velocity abrasive matter, airborne respirable particulates (potentially contaminated) and noise.
- The blast nozzle control (deadman) switch is located near the nozzle in a position where the operator's hands will be when using the device. When released, the control switch shall immediately stop the flow of material.
- Abrasive blast cleaning nozzles shall be equipped with a valve which must be held open manually during operations.
- The blast nozzle shall be bonded and grounded to prevent the build-up of static charges.
- Utilize intrinsically safe switches when applicable, or as determined by the Hazard Assessment.
- Utilize whip checks and clips/wires to prevent accidental decoupling on hoses.
- Provide a designated area for the removal of PPE separate from the lunch/office space to eliminate cross contamination; establish and practice personal hygiene standards (e.g. wash before you eat).
- Workers do not use compressed air for cleaning themselves or their clothing.

- Only Company-approved abrasive blast media is used. Recycled glass-based media is recommended. Abrasive blast media containing crystalline silica shall not be used.
- Contractor shall contact the Company Environment Department for assistance in obtaining the approved disposal methods, record retention requirements and approvals.
- Contractor shall use reasonable efforts to collect spent abrasive blast media and is responsible for collecting, storing, testing, and disposing of spent abrasive blast media in accordance with the Waste Management Plan. Do not re-use abrasive blast media.
- The records shall contain the type and volume of abrasive blast media, laboratory results and disposal location.
- Implement dust control/collection measures:
  - line the bottom of the work area with 4 mm (mil) polyethylene sheeting (contact the Environmental Department for alternatives to this requirement based on blasting media and project scope)
  - erect a shroud (e.g., tarpaulin) in densely populated areas, or if migrating dusts are problematic and/or as required by applicable regulations
  - consider using a portable air filtration system with High-Efficiency Particulate Air (HEPA) filter when using a shroud or in a Confined Space
  - consider using a negative pressure HEPA filter exhaust system when blasting within a tank
  - stop work and collect spent abrasive blast media, as required
- Abrasive blasting equipment used to clean tanks has the blasting hose nozzle bonded electrically to the tank shell or the tank roof.
- Consult with Company Operations Representative when abrasive blasting of external floating tank roofs (work to be performed in accordance with API RP 2027).
- When abrasive blasting for extended periods, a Worker rotation plan shall be implemented to reduce exposure time.

**The Abrasive Blasting Operator shall:**

- Not place hoses and lines on main roadways or walkways, whenever possible.
- Verify that the control switch is guarded, to prevent inadvertent activation.
- Have the nozzle under control before the air is turned on.
- Have control of the nozzle's control (deadman) switch.
- Not reposition from the immediate work area (e.g., lateral, or vertical body movement) while discharging blasting media.
- Ensure the abrasive blast pot is shut off and depressurized before being filled.
- When reasonably practicable, before leaving the worksite at the end of each day, remove and dispose of coveralls and shower where practical.



## 5.2 Aerial Work Platforms

### **Contractors shall ensure that:**

- Aerial lift equipment is utilized as designed to lift personnel and limited work tools to elevated locations and is not designed to hoist pipe, conduit, sheeting, or other construction material.
- Pre-job planning includes expected loading of the lift platform, overhead obstructions, high voltage conductors and weather conditions.
- Aerial lift operators are trained and certified by a competent instructor. AWP's are not to be used as elevators for accessing fixed elevated work areas. If this is required, then approval must be obtained from Company and the JSA or JHA must review, in detail, how 100% fall protection is maintained.
- Aerial lifts lifting capacity and operating specifications shall not be exceeded.
- All aerial lifting equipment shall operate on stable ground in a level position.
- No aerial work platform (AWP) shall be used if any safety device is inoperative.
- Working from an Aerial Lift requires the use of a full body harness with a lanyard attached to the designed point on the bucket.
- AWP's shall only be moved with the basket at slight elevation from ground level and with the help of a Spotter.
- Aerial work platforms shall be securely fastened in place, braced if necessary to ensure their stability and provided with cleats or surfaced in a manner that provides a safe footing for Workers.
- No person shall use an AWP that does not have proper inspection and maintenance records. Records shall indicate that the AWP provider has maintained the AWP according to the manufacturer requirements. Records shall be available for no less than two years.
- The maintenance record shall be signed and dated by a qualified inspector.
- All platforms must have a toe board that extends from the floor of the aerial work platform to a height of not less than 12.5 cm (5 in).
- If the tools or other objects are piled to such a height that a toe board would not prevent the tools or other objects from falling, a solid or mesh panel shall be installed from the floor to a height of not less than 45 cm (17.7 in).
- Temporary work platforms are used where it is reasonably practical to use a permanent structure.

### **Contractors shall ensure that Workers:**

- Workers know and follow the safe techniques for operating the aerial equipment.
- Wear required PPE (refer to section 4.35). For fall protection refer to section 4.15.
- Document pre-use inspections of all aerial lift equipment before use to ensure proper operating condition and mechanical condition.
- Ensure that access to the work area under the elevated work platform shall be controlled using barricades, barrier tape and/or a Spotter.
- Remove keys when not in use.

## 5.3 All-Terrain and Off-Road Vehicles

### Contractors shall ensure that:

- ATV use is restricted. “Trike” use is strictly prohibited.
- Due to use of Utility Terrain Vehicle (UTV) on steep, uneven terrain and all types of conditions, a certified ROP is required.
- Off road equipment may only be used when the potential of tipping or rollover have been properly assessed and risks mitigated.
- All off-road vehicles shall carry no more than the number of people that the vehicle is designed to carry.
- The manufacturer’s rated vehicle capacity for loads when carrying or towing a trailer is followed.
- All off-road vehicles shall be provided with:
  - adequate front and rear lights
  - adequate tire and braking systems for expected terrain
  - a winch that is adequately rated for emergency towing
  - a screen, shield, grill, deflector, guard, or other adequate protection for the operator where the operator may be exposed to the hazard of flying objects
  - where required, have license plates security attached in a visible location
  - be equipped with an aerial whip and flag, First Aid kit (if deemed necessary by hazard assessment), 5 lb. ABC fire extinguisher, plus portable communication equipment as required (e.g., hand-held radio, cellular or satellite phone)
  - be equipped with spark arrestors as required by Applicable Legislation
  - have an emergency kit depending on the conditions and use as required by the Hazard Assessment
- Operators are protected from falling, flying, or intruding objects by means of suitable guards or structures (independently certified or manufacturer’s side doors and undercarriage skid plates).
- Maintenance records must be kept and made available to the Operator.
- Proper servicing and maintenance appropriate to conditions of use includes restricting modifications to the structural supports of the drive train of these units.
- Trailers are required to be used to transport UTVs. When transporting off-road equipment on a trailer, the trailer must have the appropriate rating, ensuring that the load does not exceed combined gross vehicle weight and trailer rated capacity.
- Off-road transports must be well secured to the transport vehicle, with the transmission in gear and the parking brake set. The transporting vehicle must be of adequately rated capacity and have the capability to haul the equipment without exceeding the vehicle’s gross vehicle weight rating (GVWR).
- The off-road equipment shall be secured using a commercially manufactured restraining device or four tie-downs, two in front and two in back, to prevent forward, backward, and sideways movement. All tie-down straps must be in good condition, free of frays/splices.
- Any materials, equipment, or gear in the pick-up bed must always be secured from movement.
- Loading ramps must meet the following criteria:

- Fabricated of aluminum or steel and of welded construction. Driving surface must have closely spaced crossed members or mesh construction with high traction surface.
  - May be of one or two-piece design, rigid or folding. Hinges must be factory installed.
  - Adequately rated to support the combined weight of the equipment, the rider, and any cargo that cannot be removed from the machine for loading.
- When Loading / Unloading, loading ramps must be secured to transport vehicle with two tie-down straps, chains, steel cables, or mechanical fasteners, and capable of supporting the equipment and associated equipment.

**Contractors shall ensure that Workers:**

- Carry appropriate license and registration.
- Demonstrate operating competency to a qualified Supervisor or Instructor.
- Assess the risk of tipping or rollover prior to use. Risks including terrain (smoothness/roughness), traction, grade, and space to maneuver must be considered by the Operator.
- Plan routes to avoid severe slopes and unstable ground conditions.
- Inform others of departure and return times prior to leaving.
- Receive property owner's permission prior to operating on private land.
- Do not operate at excessive speeds or engage in horseplay.
- Do not operate on highways (crossing a highway is permitted).
- Remain on approved routes and operate within legal requirements.
- Document pre-use inspections on equipment. Inspect equipment at periodic intervals during the day, to ensure good condition.
- Wear seatbelts whenever the equipment is in motion or could become unstable.
- Wear required PPE (refer to section 4.35).
- Remove keys when not in use.
- Operators shall wear the PPE recommended by the manufacturer while loading / unloading off-road equipment.
- Verify that portable or detachable containers with hazardous materials contents, such as pesticide, flammable solids or flammable liquids shall:
  - Be secured separately from the equipment inside the bed of the truck to prevent movement. Tanks that are specifically manufactured to be solidly attached to the equipment for repeated use are not portable containers and do not have to be removed prior to transport. Such tanks may only contain small quantities of residual contents prior to loading or transport.
  - Be in good condition, free of leaks and residue on their exteriors, properly labeled, and meet DOT specifications for over the road transportation requirements.

## 5.4 Aviation Safety

### **Contractors shall ensure that:**

- Prior to each day's operation involving the use of a helicopter, a briefing shall be conducted which should include all passengers and the pilot's plan of operation.
- Good housekeeping shall be maintained in all helicopters loading and unloading areas.
- Loose fitting clothing shall not be worn around helicopter operations.
- Ground personnel shall be instructed of all issues regarding visibility and if necessary special precautions shall be taken to eliminate hazards.
- Passenger entry and exit will only be completed when the aircraft rotor system is either stopped or is running at 100 percent. No passenger movement will be allowed while the aircraft rotor system is starting or stopping.
  - Before approaching aircraft, secure any loose articles worn.
  - Do not carry long items vertically while approaching aircraft. If carrying an object of 2 m (4 ft.) in length or longer, there must be a person on both ends of that object.
  - Approach only the front of the aircraft, at a 45° (degree) angle, so the pilot will see you. Keep eye contact with the pilot as you approach the aircraft.
  - Walk in a crouched position when the rotor blades are turning with the power off. The pilot will indicate when it is safe to approach the helicopter.
  - At offshore locations, always walk within the boundaries of the helideck.
  - Workers will wear safety glasses and earplugs when approaching a helicopter.
- After landing, if the aircraft is to be shut down, passengers are to remain on board and are not allowed to be boarded until the rotors have come to complete stop.
  - During air medical operations, Air Medical crews, and other crew members, are exempt from this requirement.
- There shall be reliable communications established between the pilot, passengers, and ground personnel.
- Workers shall maintain a safe distance of at least 61 m (200 ft.) from a helicopter while it is lifting or landing a load.
- When approaching a helicopter with blades in rotation, all Workers shall remain in full view of the pilot. Approach only when the pilot indicates that it is safe to do so.
  - The pilot is responsible for correct weight and balance of the aircraft. Only assist with loading heavy or bulky equipment or materials under the pilot's supervision.

### **Transportation of Hazardous/Dangerous Goods by Air**

- Company Aviation does not transport hazardous/dangerous goods by air. If using a contracted carrier, the carrier must, at all times, hold the appropriate approval from the aviation authority in order to transport hazardous or dangerous goods by air for Company
- In the absence of aviation regulations that set a more stringent standard, the carrier must accept, handle, load, and transport hazardous or dangerous goods in compliance with the IATA Regulations (International Air Transport Association).
- The pilot in command MUST be informed of any dangerous goods cargo before the start of the flight.

- Lithium Polymer (LiPo) batteries used in UAS are considered dangerous goods. Check with the UAS Program Manager if you are not sure if a particular UAS or UAS battery can be shipped or transported by air and what paperwork may be required.

### **Pre-Trip Guidelines**

- Accurately report the weights of extra equipment and personnel being carried on board the aircraft.
- Load gear into the aircraft only with the pilot's approval to ensure proper weight distribution.
- **Never bring bear spray** into a helicopter. If you must carry it for work purposes, notify the pilot and ensure that it is stored properly for transport as per the pilot's directions.
- Never walk within the vicinity of the tail rotor. Do not go beyond the baggage compartment.
- Do not duck under the tail boom to get to the other side of the aircraft. Walk around the front of the helicopter.
- When entering the aircraft, be careful not to step on any float bags that may be present.
- Listen to the pilot's briefing before taking off.
- Familiarize yourself with the location of the emergency equipment and the exit nearest you inside the aircraft.
- Normally, helicopters are equipped with 2-way headsets for all passengers and the pilot. If you have questions, feel sick, or need to communicate with the pilot, use the 2-way headset.

### **Rigger shall:**

- Be trained for rigging helicopter loads and for overhead crane loading including load preparations, securement, and procedures as per local/applicable legislation and/or carrier requirements,
- Inspect the safety devices of all rigging equipment or installed rigging devices on equipment to be lifted. Only the pilot in command or flight crew members shall test the lifting equipment and ensure it meets legislative and engineering requirements,
- Have experience consistent with the requirements of the lift to be made,
- Be physically and mentally able to accomplish required rigging tasks,
- Perform visual equipment inspections of rigging equipment to ensure cleanliness and that it is in good condition; remove all equipment from service that does not meet visual inspection until it can be verified to be in safe working condition in accordance with the manufacturer specifications, and
  - Maintain a written record or logbook of these inspections when applicable.

### **Spotter/Signal Person shall:**

- Will be familiar with helicopter lift hand signals and consult with the pilot in command on his/her preference for hand signal use,
- Complete any specific training required by applicable legislation and/or as required by the company in charge of the lift. Consult with the pilot in command to ensure operations are understood and that requirements are clear,
- Wear appropriate PPE to distinguish themselves from other workers,

- Supervise the landing/loading area(s) to ensure personnel do not enter the area while lifts are happening and halt operations if a unauthorized entry is made,
- Observe and communicate on the movement of the load or communicate any other information the pilot in command may need to know by either hand signals or radio, and
- Ensure no personnel are stationed in the flight path of a suspended load taking-off and/or being landed.

### **Unmanned Aircraft Systems**

- The use of Unmanned Aerial Vehicles (UAV) also known as “drones” in the vicinity of Company Locations requires approval from Aviation Services.
- UAS Project Approvals Process must be completed prior to their use.
- Do not approach a UAV unless the pilot advises that the controls are secure and that it is safe to approach. The landing/take off area for the UAV will be clearly delineated with cones and appropriate signage.
- Do not stand beneath a hovering UAV.

### **Planning for UAS Operations**

- In planning the layout of a work site, the following minimum information must be considered when developing the pre-job or project plan:
  - Planned take off/landing areas and approach/departure paths with consideration of prevailing wind patterns, mechanical turbulence, built up areas, and obstacles if applicable (i.e., departure or approach near homes or farms with livestock),
  - Location of work areas for the various elements of the operation,
  - Location of emergency landing areas,
  - Location of landing areas,
  - Location of any travelled roadway,
  - Location of any potential hazards such as power lines, buildings, structures, or tall trees,
  - Known sources of potential radio interference (EMI/RFI).
- Workers must be informed of the work plan as well as the helicopter flight path to and from the helipad and/or landing zones. Flight paths and operational areas must be kept clear of equipment, or personnel other than flight personnel necessary to assist in landing and take-off.
- Workers must not be placed in an area where there are overhead hazards.
- Before UAS operations begin, the visual observer, supervisor and workers involved in the operation must meet with the pilot in command to establish:
  - Plans and procedures to be used,
  - Corrective measures required to minimize risks of injury to workers,
  - Limitations and risks associated to the UAS,
  - Communication between the pilot and ground crew should be established by implementing the following minimum requirements:
    - Establish an effective system of voice communication signals between the pilot and the visual observers/ground crew (noise and distance may prevent verbal communication),

- If available, two-way radio communication equipment shall be tested and the channels to be used established before operations begin. This is essential for UAS operations where direct verbal communications are not possible,
- Established exact voice or hand signal commands to avoid any possibility of misunderstanding: all communication should be pertinent and brief,
- Clearly marked location of cables and all known hazards in the way of anticipated flight paths on the plans and make the pilot aware of them.

### **Visual Observer (UAS):**

- Review the Visual Observer Briefing document and communicate any concerns directly with the pilot verbally,
- Always follow the instructions of the pilot in command and assist the pilot with keeping the landing/take-off area clear when not required to be observing the UAV or during emergencies.
- Always remain within direct voice contact with the pilot (by radio if remaining near the pilot is not possible while performing their duties),
- Always maintain visual contact with the UAV with no exception, and
- Not perform any other duties other than those detailed in the Visual Observer briefing. They must not be distracted by other Workers or activities that would take attention away from their primary duties.

### **UAS Pilot shall:**

- Ensure that you have reviewed the Visual Observer Briefing with your visual observer and that they clearly understand their role, and
- Ensure that you have established a communication protocol with the visual observer.

### **In-Transit Guidelines for Helicopters**

- Seat belts, shoulder harness, and hearing protection shall always be worn while the aircraft is in motion. Ensure that the buckle of the seat belt is facing outward.
- If the flight will be over water, a PFD will be worn while the aircraft is in motion.
- All flights are designated “NO SMOKING”.
- Before take-off ensure all doors are closed and nothing is hanging out of the doors, windows, or baggage compartment.
- Always read the emergency briefing card before each flight.
- To ensure helicopter doors are not damaged, passengers must not:
  - Lean against or use force on doors or windows
  - Slam the doors or use force on door handles or latches
  - Touch any moving parts or fragile protruding parts that are attached to the doors, such as antennas or lights

## Helicopter – Slinging Operations

- Helicopters (including those involved in slinging operations) shall be operated with a 5% power reserve. Pilots may reduce the 5% power reserve only in ideal flight conditions; if a lesser reserve is used, it shall guarantee adequate power for an abort in the event of changing flight conditions. However, the pilot shall maintain some power reserve.
- Workers working around helicopters during slinging operations shall:
  - keep the area free of loose articles
  - watch for Hazards, such as obstacles or hanging trees that may fall when dislodged by the helicopter rotors or by gusty wind conditions
  - stay alert and be aware of the positioning of loads
  - maintain visual contact with the load (and cargo hooks) until it clears the location
  - keep a safe distance from the loads
  - remain clear of incoming loads (and cargo hooks) until they are placed on the ground
  - determine an escape route that leads away from the load, and ensure it remains clear of objects or potential blockages
  - always stand uphill from the load, as it may roll when released
  - maneuver the load only when necessary and only by pushing it into position; do not reach for a load or cargo hook
- For slinging (long-line) operations, follow these requirements:
  - use only multi-stranded steel core long lines, cables or lanyards
  - use long lines and lanyards swaged with steel; do not use cable clamps
  - attach only properly sized clevises to the helicopter hook (either the belly hook or the extended hook) and keep all screw-type clevis pins tight and lock-wired
  - use only the proper type of clevis pins (not bolts) and check clevises before and after each lift
  - complete record of inspection and logbooks
  - secure loads of loose articles in cargo nets
  - advise the pilot of the presence of any Hazardous Materials
  - do not conduct long line operations overpopulated areas
  - do not conduct long line operations within 100 m (110 yd.) of high-voltage power lines
  - cease operations during electrical storms
  - ground all loads to prevent a buildup of static electricity (static prevention is meant to prevent possible electrical injury to Spotters)
- Before commencing slinging operations, designate one person as Spotter and ensure that radio frequencies are established.
- The Spotter is the only person permitted to stand beneath the helicopter during slinging operations unless another person is required to help position the load.
- The Spotter is the only person permitted to use hand signals.
- The Spotter shall:



- use standard hand signals when the helicopter is operating directly overhead and when it is impossible to use radio communication
- confirm that the pilot has visual contact of the Spotter by radio prior to using hand signals
- ensure standard helicopter hand signals are practiced prior to the start of operations; this ensures signals are agreed upon and understood by both the pilot and Spotter
- use large movements when using hand signals, especially when using long lines this is necessary because the pilot may be as high as 45 m (150 ft.) above the Spotter)
- In addition to wearing basic PPE, the Spotter shall always wear the following PPE during slinging operations:
  - head protection with chin strap
  - protection from static (e.g., high-voltage gloves) during cold weather/low humidity
  - High Visibility Vest

### **Emergency Equipment**

- During the preflight briefing, the pilot must:
  - Identify the location of the emergency locator transmitter (ELT), survival equipment and first aid supplies
  - Explain the proper operation of the ELT
- The pilot must provide a life jacket for every passenger when operating from water.
- For long flights over water, Passengers must note the location of oxygen masks (if applicable) and know how to start the flow of oxygen.

### **Contractors shall ensure that Workers:**

- Follow the established flight procedures and instructions from the pilot.
- Participate in helicopter activities only after receiving the proper training.
- Demonstrate a complete understanding of the safe work practices to be followed while moving around helicopters.
- Follow the pilot's instructions regarding the aircraft.
- Contractors will wear safety glasses and earplugs when approaching a helicopter.

## 5.5 Boom Truck and Rigging

### Contractors shall ensure that:

- Operator has current proper certifications for boom truck operation.
- Operator knows and follows the operating procedures for boom trucks.
- All boom truck lifting equipment shall be visually inspected at the start of any lifting task.
- All boom trucks shall be equipped with a load chart showing the rated load capacity at all boom angles and boom radiuses.
- All Serious or Critical Lifts must be performed in accordance with the Serious and Critical Lifts Section.
- All boom trucks shall be equipped with an effective back up alarm system.
- Working from an aerial lift bucket requires the use of a full body harness with a lanyard attached to the designed point on the bucket.
- Unless the equipment operator has an unobstructed and clear view of the lift operation, a designed signal person must be used to communicate with the equipment Operator. This applies to all types of lifts.
- The equipment must not be used unless Ground Conditions are firm, drained and graded to a sufficient extent so that in conjunction (if necessary) with the use of Supporting Materials, the equipment manufacturer's specifications for adequate support and degree of level of the equipment are met.
- Rated load capacities for the boom shall be posted and visible to the Operator while at the control station.
- All boom trucks shall be equipped with an effective back up alarm system.
- Do not exceed the lift capacity of the lifting equipment on the truck.
- A clear lift and operating zone which includes barricades if needed and clearances from hazardous equipment and electrical power lines are established.
- Remove keys when not in use.
- Rigger must know and follow proper rigging principles for a lift.
- All rigging equipment shall be inspected before each use.
- Basic rigging and load handling principles and minimal guidelines are listed as follows:
  - All lift rigging assemblies and spreader bars shall have a Working Load Limit (WLL)/Safe Working Load (SWL) that shall not be exceeded.
  - Alignment of the rigging slings shall be checked as the load is pulled tight on the rigging or sling before the actual load is lifted clear of any support.
  - Tag lines shall be used to control load swing, rotation and/or balance, when necessary, to prevent a hazard to workers. When the bottom of the load is waist high or lower, tag lines are not required, but can be used if additional stability is desired.
  - All wire rope and synthetic slings, lifting hooks, shackles, alloy chains and lifting eyes shall be visually inspected prior to any lift.
  - Damaged or suspect rigging equipment shall not be used and will be removed from service.

- Follow the practice of level load lifting to ensure the rated capacity of the slings or chains is not exceeded.
- Boom trucks will not be operated where the any part of the crane, jib, hoist, load, tag line or rigging will come within the minimum clearance distance of overhead power lines (request clearance tables from company).
- All boom truck / lifting equipment is regularly inspected.
- Follow the following sections contained in Section 4.11 Crane and Hoist Safety
  - Inspections and Maintenance
  - Hoisting and Mechanical Lifting
  - Slings – Safe Operating
  - Alloy Steel Chain Slings
  - Wire Rope
  - Synthetic Web Slings
  - Hooks

## 5.6 Bonding and Grounding

### **Contractors shall ensure that:**

- Contractors shall develop a safe work plan for controlling induced voltage. This plan shall include, but is not limited to, the following:
  - specialized PPE
  - measuring/testing
  - grounding requirements for planned work
  - work stoppage for adverse weather conditions
- Contractor's plan shall also consider these additional factors:
  - The voltage level depends on the current in the transmission lines, the geometric configuration of the pipeline with respect to the transmission lines, and the length of pipeline paralleling the transmission line.
  - Induced voltage caused by proximity to overhead transmission lines may continue to affect pipelines, even when the pipeline no longer parallels the transmission cables. Induced voltage can be a hazard for up to 16 km (10 mi) beyond the point of departure.
  - Once a Below Grade Facility is exposed, it shall be checked for induced voltage prior to commencing work on the Facility. The Facility shall be continually checked for induced voltage as required or monitored based on the Hazard Assessment.
  - The industry-accepted safe limit for induced voltage limit on pipelines, Appurtenances and other below grade facilities is 15V. Bonding and Grounding is therefore required to bleed off any charge more than 15V.
  - If further aid is required to reduce the induced voltage to below 15V, contact Company Operations Engineering to determine the need to install a grounding grid for Bonding and grounding Below Grade Facilities, vehicles, and equipment. If a grounding grid is installed, before starting work, ensure induced voltages on the bonded pipe, vehicles and equipment have been reduced to an acceptable level
  - Potential induction sites/areas shall be tested by a Qualified Worker.
  - Only Qualified Workers are to mitigate induced voltage hazards.
  - When the potential for induced voltage exists, a Hazard Assessment shall be completed and reviewed, with the involvement of the Workers doing the work.
- Prior to use and during use, all portable equipment used in Bonding and Grounding work (e.g., welding units, generators, portable light plants, air compressors, etc.) shall be properly grounded, in accordance with manufacturers' specifications and Worksite requirements.
- Bonding cables shall meet Company requirements set out in these Specifications, industry standards and Applicable Legislation.
- When drawing oil or product samples from the line, or when loading or off-loading at sump tank locations, use an uncovered braided copper wire with an alligator clip brazed/clamped to each end (or use other suitable Bonding cable)

**Contractors shall ensure that Workers:**

- Attach one end of the Bonding cable to a ground consisting of a copper ground rod.
- Type and depth of copper rod to be used shall be based on job planning requirements.
- Avoid breaking, cutting, or detaching Bonding cables once they are in place, for as long as a fire hazard exists.
- Ground or electrically bond containers to each other when transferring liquids.
- Only fill portable fuel containers when they are on the ground (never do so in truck beds, on tailgates or in the trunks of vehicles).
- Immediately contact Qualified Workers if there are any concerns about induced high voltage and work equipment.
- Ensure each Bonding or grounding point is clean and free of paint, with a positive connection.
- Never use chains for Bonding or grounding purposes.
- Perform visual inspection of the cables and connection as required to ensure positive connection is maintained.
- Bond and/or ground when completing the following tasks:
  - cutting and separating a pipeline
  - separating flanges
  - loading or off-loading at sump tank locations
  - dispensing flammable liquids from bulk drums into a secondary container
  - removing an accessory attachment from a fixed Facility (e.g., a mixer from a tank)
  - using abrasive blasting equipment to clean tanks
  - hydrovacating
  - spray painting
  - when using compressors, pumps, and generators
  - drawing samples from a pipeline
  - drawing liquids from a pipeline into a pan
  - when AC voltage is present

(See table below for installation requirements for Bonding Cables)

**Table 1: Installing Bonding Cables**

TASK	BOND FROM	BOND TO	NOTES
Abrasive Blasting Equipment for Tank Cleaning	Blasting Hose Nozzle.	Tank Shell or Tank Roof.	N/A
Cutting, Installing and Separating of a Pipeline	Grounding Clamp on one side of separation. Second cable from grounding clamp on one side of separation.	Grounding Clamp on other side of separation. Grounding clamp on pipe section to be removed or installed.	Ensure clamps contact clean, bare metal. First cable shall be long enough to span the work area. Second cable shall be long enough to clear the hazardous area when removing or installing pipe section.

TASK	BOND FROM	BOND TO	NOTES
Drawing Samples from Pipeline	Attach alligator clip on one end of Bonding cable (unbraided copper) to sample point on pipeline (i.e., pipe, valve).	Other end of Bonding cable to alligator clip on metal sample container.	N/A
Draining Oil from Pipeline to Pan	Pipeline.	Metal Drain Tray.	For plastic drain trays, second end of Bonding cable shall always remain in contact with liquid being drained into tray.
Loading or Off-loading at Sump Tank Locations	Object being loaded/off-loaded.	Sump tank or piping connection at loading / off-loading Facility.	For fiberglass sump tanks, attach second end to a specified bonding point.
Dispensing from Bulk Drums to Secondary Container	Bulk Drum.	Secondary Container.	One container shall be grounded, and the other container bonded to the grounded container.
Removing accessory attachments from fixed facilities	Clean, bare metal on accessory attachment. Flange.	Fixed Facility. Flange.	Bonding cable shall be long enough to clear the hazardous area when removing attachments or span of work area when separating flanges.
Hydrovacating Near Underground Electrical Wires	Wand/Gun Dig Tube Mat # 1 Mat #1	Grounding Mat # 1 Grounding Mat # 2 Mat # 2 Hydrovac Truck	For distances greater than (>) 1.8 m (6 ft.) from the Hydrovac truck, it may not be necessary to bond the mat to the truck (Step 4).

*NOTE: Some tasks require more than one Bonding cable. The numbers listed in this table represent steps to be taken for proper Bonding (i.e., bond 1 to 1, and 2 to 2, etc.).*

## 5.7 Brush Cutting, Clearing and Vegetation Management

### **Contractors shall ensure that:**

- The terrain is surveyed (in advance of initiating work) for hazards prior to operations.
- All applicable precautions are implemented when overhead clearing of vegetation.
- If clearing is required within limits of approach boundary to overhead powerlines a certified and / or licensed professional arborist will be utilized to perform the work. (Refer to the *Electrical Safety* section)
- Reference all owners' manuals for equipment being utilized. (Mowers, tractors, weed eaters, etc.)
- Emergency plans should be developed before beginning work to include location of nearest medical facilities, directions or GPS coordinates for EMS if working in remote location, and a check-in system for lone operators.
- Equipment Protective Guards and Systems includes:
  - Keeping all guards in place when the machine is in operation
  - Workers shall be protected from moving machinery parts
  - Workers are prohibited from altering/removing equipment guards and controls unless specified by manufacturer. (E.g., Temporary removal of ROPS)
  - Only hitch to the drawbar and hitch points recommended by tractor manufacturers.

### **Riding Mower and Tractor:**

- Roll Over Protection System (ROPS) are in good condition and raised into active position. Never operate equipment if it is intended to be equipped with ROPS but ROPS is not in place.
- Seat belt assemblies are on all equipment on which a ROPS has been installed and require the usage of seat belts.
- Where vertical clearance does not allow for ROPS to be raised, seatbelts shall not be worn. The ROPS shall be raised back to active position and seatbelt reconnected as soon as clearance allows.
- Riding mowers should be equipped with operator presence control system that shuts off the blades when the Operator dismounts or rises out of the seat.
- Riding mowers should be equipped with interlocks that ensure the engine cannot start while the mower is in gear or if the blade is engaged.
- Tractors should be weighted correctly for the work activities planned.
- Inspect the equipment before use and perform maintenance as per manufactures recommendation.
- Utilize insect repellents (fleas, ticks, mosquitos, etc.).
- Take measures to protect from thermal stresses. (See Heat Stress or Cold Stress Section).

### **Chainsaw**

- Utilizing chainsaws, review manufacturer's instructions on the safe use, care, and maintenance of the chainsaw prior to use. Below are a few key items to remember:
  - Use correct techniques to start chainsaw (on the ground or standing). Do not drop start or throw start the chainsaw.

- Wear proper apparel, especially chaps or leggings (to help avoid the most common cause of injuries related to chainsaws).
- Do not operate chainsaws from a ladder or above shoulder height (utilize saws with extended reach capabilities).

**Contractors shall ensure that Workers:**

- Using motorized equipment for cutting or clearing brush:
  - check the cutting area for any metal, large stones or other hard material that could damage the blades or cutter disc
  - regularly clean accumulated debris from the top of the cutter's fuel tank and from the engine, pumps and axle protection plates on a regular basis
  - ensure other Workers do not approach the brush cutter's articulating joint when the brush cutter is operating
  - operate brush cutters with protective guards installed
  - wear additional PPE as required by the Hazard Assessment
  - ensure each brush cutter has protective guards and only operate brush cutters with the guards installed
  - dispose of brush and slash by mulching and spreading on an area designated by the regional/project manager or a Company ROW agent or landowner
- Do not operate a brush cutter when other workers are within 91 m (300 ft.) of the front or sides of the brush cutter (refer to manufacturer's instructions for additional equipment-specific hazards).
- Do not operate equipment on slopes that exceed the angle limits specified by the manufacturer. If the manufacturer limits are unavailable, evaluate the terrain and slope conditions to ensure the equipment is operated in a safe manner. Avoid operating on slopes with an angle over 15 degrees when operating a riding mower or 20 degrees when operating a tractor if there is no other information available.
- When possible, back uphill and drive downhill. When driving downhill keep the equipment in low gear. Avoid mowing slopes you cannot back up unless you have equipment specifically designed and configured for crosscutting (i.e. slope mower).
- When stopping the mower / tractor:
  - Park on even ground, disengage the PTO (e.g. Bush hog) and lower all implements.
  - Place all control levers in neutral position, apply the parking brake, turn off engine and remove the keys.
  - Ensure the tractor has come to a complete stop before dismounting.
- Equipment should only be left unattended when it is on level ground with the brake set and the key removed.
- Do not operate equipment within 1.5 m (5 ft.) of the unprotected edges of retaining walls, embankments, levees, ditches, culverts, excavations, or similar locations that present an overturn or roll-over hazard.
- Do not mow wet grass on sloped surfaces. Reduced traction could cause sliding.



## 5.8 Compressed Gas Cylinders

### **Contractors shall ensure that:**

- Gas cylinders are handled, maintained, and stored according to these Specification requirements.
- Workers are properly trained prior to using and handling of compressed gas cylinders.
- Compressed gas cylinders, portable tanks, and cargo tanks shall have pressure relief devices installed.
- Oil or grease shall not be used on threaded portions of oxygen or acetylene cylinders or gauges.
- Cylinders equipped with gauges which will not be used for substantial periods of time, such as overnight, shall have the cylinder valves closed and cap secured.
- Cylinders ‘in service’ on welding trucks are not required to have protective caps in place if they do not protrude above the headache rack. Also, gauges need not be removed if an approved cart is used for cylinder movement.
- Pressure cylinders are in “storage” if they are not in use or connected for use.
- Store cylinders out of direct sunlight, when possible.
- Keep all empty cylinders for the same kind of gas together.
- Separate full cylinders from empty ones. Empty cylinders shall be marked “Empty” or “MT” with chalk.
- Never store cylinder where the temperature may rise above 130°F.
- Never store cylinders near elevators, stairs, gangways, foot bridges, evacuation routes, operating cranes or where something might drop on them, hit them or knock them over.
- Compressed gas cylinders shall be secured in an upright position with the protective cap in place when the cylinder is not in use (e.g., cylinder storage rack) except, if necessary, for short periods of time while cylinders are being:
  - hoisted or carried,
  - transported (provided they are adequately secured against movement and any TDG/DOT requirements are met)
- Acetylene and CO<sub>2</sub> compressed gas as well as cylinders containing pressurized liquid Oxygen, Nitrogen, or Argon must be always kept in an upright position.
- Post conspicuous “NO SMOKING” signs around the flammable gas storage area.
- When stored, flammable gas cylinders and compressed oxygen cylinders shall be separated by at least 6 m (20 ft.) or by a non-combustible barrier 1.5 m (5 ft.) high with a fire-resistant rating of at least one-half hour.
- Adequate precautions shall be taken to prevent the ignition of flammable vapors.
- Inspect cylinders for corrosion, dents, and gouges and, if necessary, notify the supplier to remove the cylinder from the worksite.

### **Oxygen Cylinders**

- Oxygen cylinders shall be separated from flammable gas (fuel-gas) cylinders or combustible materials (especially oil or grease), a minimum distance of 6 m (20 ft.) or by a noncombustible barrier at least 1.5 m (5 ft.) high having a fire-resistance rating of at least one-half hour.
- Post conspicuous “NO SMOKING – OXYGEN” signs around the oxygen cylinder storage area.

- Gauges used for oxygen service must be marked: “USE NO OIL”
- Oxygen shall not be used as a substitute for compressed air.

### **Aerosols**

- Aerosols shall be stored under cover, protected from exposure to the weather and direct sunlight, and kept at least 3 m (10 ft.) from any source of heat or ignition.
- Aerosol cans are stored at the correct temperature as recommended by the manufacturer.
- Where aerosols are kept in distribution centers, they shall be stored within strong mesh enclosures (i.e., caged).

### **Contractors shall ensure that Workers:**

- Review SDS of flammable or combustible product to determine the correct class prior to product use.
- Conduct a visual inspection to determine if compressed gas cylinders are in a safe condition prior to each use.
- Always wear the appropriate protective gloves when handling cylinders.
- Handle cylinders with great care, even when empty.
- Use a mechanical lifting device, carts, mag-carts, or dollies to move and load cylinders, where possible.
- Use a cradle, boat, or suitable platform when using a crane or derrick to move a cylinder. Slings or electric magnets shall not be used for this purpose.
- Take care to never drop cylinders or submit them to shock.
- Avoid dragging or sliding cylinders.
- Never lift cylinders by their cap.
- Cap cylinder valves before moving and loading.
- Close cylinder valves and release all pressure from the regulators, before removing a regulator from a cylinder.
- Never try to refill cylinders to mix gases in a cylinder or transfer gas from one cylinder to another unless transferring breathing air.
- Smoking is strictly forbidden when moving, loading, transporting, or unloading any cylinder, whether it contains flammable gas or not.

### **General Regulator Operation:**

- Use approved regulators or reducing valves only for the gas and pressures for which they are intended.
- Inspect the regulator, union nuts and connections before each use to detect faulty seals that may cause leaks.
- Replace damaged nuts or connections
- Do not use leaking regulators.
- Return regulators to the supplier for repair, calibration, or adjustment.
- Fully release the regulator pressure-adjusting screw before attaching a regulator to a cylinder and before opening the cylinder.

- Always stand to the side when adjusting regulators.
- Follow work procedures when working with a flammable material or in a potentially explosive atmosphere.
- Do not use oil or grease as a lubricant for regulators or fittings on Oxygen Cylinder Regulators.

### **Propane Bottles and Accessories**

- When a propane bottle is in use, fully open the valve, when not in use, fully close the valve. Do not use the valve to regulate the flow of propane.
- Store propane compressed gas Cylinders as follows:
  - outdoors on concrete or other non-combustible platforms
  - in an area that provides protection from tampering
  - in an area free of vehicle or mobile equipment travel; if propane Cylinders are required to be temporarily stored in areas vehicle traffic is expected then they shall be protected by barriers
  - away from a fire escape, stairs or building egress
  - at least 7.5 m (23 ft.) away from buildings, unless in an approved storage cabinet; if using an approved storage cabinet, then store 1 m (3 ft.) away from buildings and 3 m (9ft.) away from air intakes
  - at least 1 m (3 ft.) from other flammable compressed gas containers (e.g., acetylene)
  - at least 6m (20 ft.) from containers or dispensers for Flammable Liquids and Combustible Liquids (e.g., gasoline and diesel fuel), or Cylinders of compressed oxygen
- Propane fueled, hand-held torches shall be used for their intended purpose, which is to be hand-held, and under constant supervision.
  - These torches shall only be used for pre-heating of piping and other specific intended purposes prior to welding.
  - They shall not be used for temporary heating and shall never be unattended.

## 5.9 Confined Space Entry

### **Contractors shall ensure that:**

- Provide a written Confined Space work plan and any procedures that will be followed as part of any Permit Required Confined Space Entry.
- Provide a copy of the Confined Space Entry Permit system they will use on site.
- Provide evidence on demand of appropriate training for any personnel assigned to serve as Entry Supervisor, Authorized Entrant, Attendant, or Rescue.
- Confirm they will either provide rescue personnel or contract rescue personnel for any Standard Entry into a Permit Required Confined Space.
- Engage in pre-planning activities and make their personnel available for pre-entry meetings and post-entry debriefing activities.
- Engage in the communication process with Company before an entry into a Permit Required Confined Space to ensure there is a full discussion on:
  - The hazards presented by the Confined Space.
  - Any preparation or control activities already conducted on the Confined Space such as isolation lock out / tag out, mechanical ventilation, etc.
  - Additional control measures or activities that the Contractor is responsible to implement or conduct.
  - Entry plans and any job planning documents (including JSAs performed as part of the preparation for Entry and work inside the Confined Space).
  - Confined Space Entry Permit system, which by default is the Contractor's system.
  - Any additional permitting requirements (e.g., Hot Work Permit).
  - Coordination with any other work activities that may be ongoing just before or during entries.
  - Rescue plans (whether provided by Contractor personnel themselves or by another contracted third party).
- When considering work that must be performed inside a Confined Space, the following priorities should be followed:
  1. If possible, conduct the work from outside the Confined Space (i.e., avoid Entry altogether)
  2. If #1 is not possible, remove all hazards capable of causing death or physical injury and any potential for a hazardous atmosphere to classify the Confined Space as a Non-Permit Required Confined Space permanently or temporarily.
  3. If #2 is not possible, remove all hazards capable of causing death or physical injury and use mechanical ventilation as necessary to prevent a hazardous atmosphere to allow for an Alternate Entry into a Permit Required Confined Space.
- Create or review a written Confined Space Entry Plan prior to conducting Permit Required Confined Space Entries.
- The plan must address:
  - Identification of the site/location and spaces where work is to be performed.
  - Specific hazards associated with the Confined Space as determined through the evaluation.

- o SDSs of any chemical hazard which was present and/or eliminated.
  - o How the space will be prepared.
  - o How the hazards will be eliminated and/or controlled.
  - o Consideration should also be given to activities to be performed in or around the Entry locations or other air intake locations which may have a potentially negative impact on atmospheric conditions within the Confined Space.
  - o Monitoring requirements and equipment to be used during the Entry and who will conduct monitoring.
  - o Acceptable entry conditions.
  - o Entry procedures (including whether Standard, Alternate, or Non-Permit Entry procedures are anticipated during work activities).
  - o Communication methods (between Entrants and Attendants and Rescue Personnel).
  - o Emergency rescue plan and designated rescue entity.
  - o PPE and other confined space entry equipment required considering the plan.
  - o Review of potential new hazards introduced or discovered once entry activities are underway.
- Whenever feasible, eliminate atmospheric or other hazards and confirm hazards have been eliminated from the confined space from outside the confined space to avoid entry.
  - Where entry is required to eliminate hazards and/or to confirm hazards are eliminated, the entry must be performed under the Permit Required Confined Space Standard Entry procedure.
  - For further assistance in choosing an appropriate entry procedure, see table below:

**Table 2: Minimum Entry Conditions and Requirements for Confined Space Entry Procedures**

ENTRY CONDITION / REQUIREMENTS	PERMIT REQUIRED CONFINED SPACE ENTRIES			NON-PERMIT REQUIRED CONFINED SPACE ENTRY
	STANDARD ENTRY		ALTERNATE ENTRY*	
	HOT WORK	IDLH		
<b>Entry Permit</b>	Yes	Yes	Yes	No
<b>Toxic Gas / Vapor Oxygen</b>	Toxic gases/vapors are < PEL O <sub>2</sub> is 19.5 – 23.5%	Toxic gases/vapors are > PEL and/or O <sub>2</sub> is <19.5% or >23.5%	Toxic gases/vapors are < PEL O <sub>2</sub> is 19.5 – 23.5%	Toxic gases/vapors are < PEL O <sub>2</sub> is 19.5 – 23.5%
<b>Flammable Atmosphere</b>	Zero LEL	< 10% LEL	< 10% LEL	< 10% LEL
<b>Cleaning (if and as applicable)</b>	Wash and/or steam. Remove any residual flammable substance.	Wash and/or steam Remove all free liquids and solids that may off-gas.	Wash and/or steam Remove all free liquids and solids that may off-gas.	Wash and/or steam Remove all free liquids and solids that may off-gas.
<b>Inert Purge (if and as applicable)</b>	Initial purge to eliminate flammable atmosphere.	Initial or continuous purge to eliminate flammable atmosphere.	Initial purge to eliminate flammable atmosphere.	Initial purge to eliminate flammable atmosphere.

ENTRY CONDITION / REQUIREMENTS	PERMIT REQUIRED CONFINED SPACE ENTRIES			NON-PERMIT REQUIRED CONFINED SPACE ENTRY
	STANDARD ENTRY		ALTERNATE ENTRY*	
	HOT WORK	IDLH		
<b>Ventilation</b>	Ambient ventilation until safe, or Forced air ventilation if necessary.	Ventilate as needed to control flammable atmosphere.	Continuous forced air ventilation.	Mechanical ventilation <u>not required</u> to prevent a potentially hazardous atmosphere.
<b>Respiratory Protection</b>	Wear APR as needed for welding gases/vapors. SCBAs for rescue.	Wear Supplied Air Respirator. SCBAs for rescue.	No respiratory protection needed.	No respiratory protection needed.
<b>Air Monitoring (Testing)</b>	Initial pre-entry test; continuous monitoring; periodic testing/recording.	Initial pre-entry test; continuous monitoring; periodic testing/recording.	Initial pre-entry test and continuous monitoring.	Initial pre-entry test and continuous monitoring.
<b>Attendant</b>	Yes	Yes	No	No
<b>Rescue Plan</b>	Yes	Yes	No	No

\* NOTE: Alternate Entry Procedure can be used when the only hazard posed is a potential hazardous atmosphere. If possible, reclassify the Permit Required Confined Space as a Non-Permit Confined Space.

### 5.9.1 Entry Permit Requirements

- Entry into a Permit Required Confined Space may only be authorized once the Confined Space Entry Permit is complete and authorized. For this to take place:
  - Sign the Confined Space Transfer of Control to Contractor form, which transfers authority to the Contractor, to allow the Contractor Entry Supervisor to complete the Entry Permit.
  - There must be verification that acceptable entry conditions have been met, including any hazard control measures implemented and applicable atmospheric testing.
  - All required signatures have been obtained on the permit, at minimum the Entry Supervisor (on all) and Attendant (for Standard Entry) and Authorized Entrants listed.
- Entry is only authorized for the period specified on the Entry Permit.
- The permit shall not extend past a working day or change in work shift.
- Any Authorized Entrants not named when the permit was first issued, needs to review the Entry Permit, and be added as entrants as applicable.
- If a change in Entrants is necessary, a new Entry Permit shall be issued.
- If the Entry Permit allows for extensions, any updating of the expiry time must be done by the Entry Supervisor.
- Post the completed Entry Permit with a few feet of the Confined Space entrance during all entry activities so it always available to consult while entry is underway. Where conditions may deteriorate the permit:

- Place the permit in a weatherproof zip lock plastic bag or the like to protect it; or
  - The attendant positioned at the entrance may hold onto the permit.
- The Entry must be terminated, and the Entry Permit cancelled by the Entry Supervisor when:
  - Entry operations covered by the permit have been completed; or
  - Conditions that are not allowed under the Entry Permit arise in or near the Confined Space or if job scope changes.
- Cancelled, expired, and completed Entry Permits must be retained for a year by the contractor for annual review purposes.
- Any problems encountered during an Entry operation must be noted on the permit for subsequent review purposes.
- Where a Permit-Required Confined Space is a process or storage vessel or space enclosing fluid handling equipment that will be opened, the vessel and/or equipment must be completely removed from service and protected against the release of energy and material into the space by such means as:
  - Blanking or Blinding – disconnection of all inlet and outlet lines and installing blind flanges or slip blinds (skillets) between flanges.
  - Misaligning or removing sections of lines, pipes, or ducts; and/or
  - Double Block and Bleed – Closure of a line, duct, or pipe by closing and locking or tagging two inline valves and by opening and locking or tagging a drain or vent valve in the line between the two closed valves.
  - If double block and bleed is used, ensure, and verify drain and/or vent is open and left open.
- Apply Lock Out / Tag Out (see Lock Out / Tag Out section).
- If Permit-Required Confined Space isolation cannot be obtained by Blanking or Blinding, misaligning or section removal, or Double Block and Bleed prior to Entry, ventilation must be used.
- Contractors conduct an annual review of the Confined Space program.
  - Reviewing entries conducted in the previous year to determine if there are lessons learned that should be applied to future Entry Plans or Entry Permits for that Confined Space or more generally.
  - The completion of this review must be documented.
- During entry activities when Confined Spaces normally bolted or locked shut may be left open, effective temporary or portable signs (as above) and barriers (e.g., cones, temporary fencing, barrier tape) shall be installed near the Confined Space to prevent unauthorized entry.
- The sign should contain wording such as shown in the figure below.

**Figure 3: Example of Permit Required Confined Space Signage Requirements**

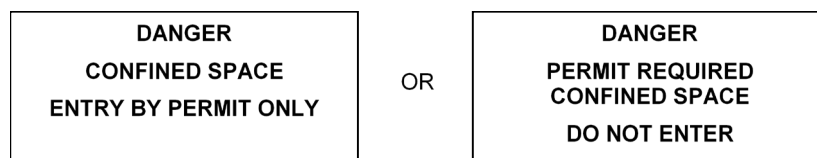

**Figure 4: Example of Non-Permit Confined Space Signage Requirements**

- If a Permit Required Confined Space is temporarily reclassified as a Non-Permit Confined Space, signs requiring permit should be covered or adjusted to prevent confusion. An appropriate type of sign is shown in the figure below.

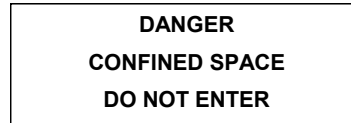
**5.9.2 Entry Equipment (for Permit Required Confined Space Entry)**

- Ventilation equipment must be used to obtain acceptable entry conditions when:
  - The permit space preparation procedures (isolation of product and/or space cleaning) cannot eliminate all atmospheric hazards.
  - The work being performed by the Authorized Entrants could pose an actual or potential atmospheric hazard. Examples would be welding, use of chemical in the space, etc.; and
  - Heat and heat stress could present a worker hazard.
- When work inside a Confined Space is underway, if necessary, use ventilation equipment to prevent the accumulation of toxic fumes or oxygen depletion due to the work being done, accumulation of dust or other particulates, and heat stress.
- Positive or negative pressure ventilation can be used to ventilate the Confined Space.
- Use direct-reading atmosphere testing/monitoring equipment (where technically possible) that is intrinsically safe and properly maintained (see further Atmosphere Testing and Monitoring).
- Provide sufficient lighting to enable the Entrants to work safely and to exit the space quickly.
- This lighting equipment must be explosion proof or intrinsically safe when being used in a Confined Space where there is a potential explosive atmospheric hazard.
  - Where possible, route electrical leads through an alternate opening other than the one used for worker Entry.
  - If not feasible, caution shall be taken to prevent an electricity related incident associated with leads running through the entry / exit point.
- Use personal protective equipment (PPE) based on the existing or potential hazard(s) within the Confined Space (and documented as controls in Pre-Entry Plans and/or the Entry Permit), See Personal Protection Equipment and Respiratory Protection sections for PPE Requirements.
- Consult with the Company, if the Confined Space has potential characteristics such as exposure to acid, alkali, carcinogenic material, or other atmospheric hazards where respiratory protection may be deemed necessary.
- Provide the Attendant, Authorized Entrant, and Rescue team with communications equipment to allow them to contact each other in event of an emergency.
  - This can be accomplished by line of sight, air horn, radios, sirens, lights, etc.
  - This should be identified in the written Confined Space Entry work plan.
- Provide an acceptable means of entering and exiting the Confined Space.



- Ensure the following rescue and emergency equipment is provided by the designated rescue contractor (at minimum):
  - Chest or Body Harness (wristlets in certain situation where this provides for a better / safer means of extraction)
  - Retrieval Line
  - Testing / Monitoring Equipment for rescue personnel (when not available at the site outside of Confined Space)
  - Mechanical Retrieval Device (in vertical type Confined Spaces)
  - Emergency Communication Equipment (see previous list for various means of communication)
  - First aid supplies must be available and affected personnel aware of the designated location.
- Ensure other equipment deemed necessary for a safe entry operation, as indicated on the Entry Permit, has been assembled and is available for use.

### 5.9.3 Atmosphere Testing and Monitoring

Test the atmosphere inside a Permit-Required Confined Space to determine if acceptable entry conditions exist before authorizing entry. Conduct the atmospheric testing in the following sequence:

- Oxygen Content
- Flammable Gas / Vapors / Mists
  - a) Typically, “LEL” reading and usually requires standard O<sub>2</sub> levels for an accurate reading
  - b) Specialized testing equipment / head is required to measure flammable gases in oxygen depleted environments (e.g., if inert gas purging is applied).
- Hazardous Substances
  - a) CO [Carbon Monoxide] and H<sub>2</sub>S [Hydrogen Sulfide] are most common
  - b) Other hazardous substances noted in the Pre-Entry Planning or Permit may also require testing, especially prior to an initial entry to determine effectiveness of purging or cleaning activities when the space was closed.
- Standard acceptable atmospheric conditions are:
  - Oxygen level between 19.5% and 23.5%
  - Flammable gas/vapor/mist less than 10% of the lower explosive limit (LEL)
  - Flammable gas/vapor/mist reading of 0% of the LEL if hot work is to be performed inside the Confined Space.
  - Hazardous substance concentrations below permissible exposure limit (PEL).

Conduct periodic and continuous atmospheric monitoring whenever there is potential for atmospheric conditions measured prior to or during Entry to change while work is being conducted (e.g., the work itself produces atmospheric hazards, there is potential for other types of off-gassing, complete isolation is not possible or only single block isolation is physically possible, migrating gases from adjacent operations, etc.).

- This requirement should be developed in the Pre-Entry Plan and documented on the Entry Permit.
- Testing/monitoring equipment must be:
  - Calibrated per manufacturer's instructions.
  - Bump tested per manufacturer's instructions prior to Entry.
  - Equipped with audible alarms when continuous monitoring is required.
  - Capable of remote sampling (i.e., internal, or external pump, real time readout, tubing and probe).
- Testing/monitoring must be performed by personnel trained to use equipment.
- Perform the initial test of the atmosphere inside the Confined Space:
  - With any forced ventilation turned off to determine potential atmosphere if ventilation fails and better determine hazard levels.
  - From outside of the Confined Space (using a pump/tubing assembly on the monitor).
  - At all levels of the space (top, middle, and bottom).
- As such, tubing on the equipment to draw a sample from inside the Confined Space must be of sufficient length to reach well inside.
- Consult manufacturer on how long it takes the device to draw a sample through the tubing to allow sufficient time for the test.
- Document all testing, monitoring and calibration results on the Entry Permit.
- Include the time, date and initials or signature of person performing the monitoring activity (use back of Permit if additional space is required).
- Never proceed with an Entry if atmosphere readings do not indicate acceptable entry conditions (based on the Entry Plan) have been met.
- Maintain an SDS of any chemical hazard which was present and eliminated from the space with the Entry Permit and/or Authorized Entrant.

#### 5.9.4 Emergency Services and Rescue Planning

Create or ensure there is a rescue plan, rescue services, and adequate rescue equipment in place prior to any Standard Entry into a Permit Required Confined Space Entry.

**NOTE:** An Alternate Entry into a Permit Required Confined Space or Entry into a Non-Permit Required Confined Space does not require rescue planning or services. However, consideration must be given to whether a Standard Entry will be required as part of the process to reclassify the Confined Space to allow Alternate or Non-Permit Entry. In that event, the rescue plan, personnel, and equipment need to be in place.

- Rescue plans should be developed by the rescue services and/or in-house rescue trained personnel (in applicable locations)
- The provisions in the rescue plan must provide assurance that all Authorized Entrants can be rescued in a timely manner based on the potential hazards within the Confined Space.
- Rescue plans shall include contact information for all responsible parties in case of an emergency (e.g., supervisor, rescue service, fire personnel, EMS, etc.).
- Rescue services may be supplied as per the contractual agreement by any of the following:

- Contractor performing Entry work provides a trained, in-house rescue service.
  - Contractor performing Entry work subcontracts the rescue services from a third party.
  - Company contracts the rescue services from a third party.
  - Local Emergency 911 Services shall not be used to provide primary rescue services for Permit Required Confined Space Entries.
- The following items must be included in the pre-planning and should be reviewed prior to each Entry:
  - Methods of summoning rescue and emergency services.
    - These may include line of sight (voice), hand-held radio, air horn, and/or telephone notification.
  - Methods of Authorized Entrant rescue.
    - The mandatory or preferred method of rescue will be dictated by the hazards of the Confined Space, and these must have been included in the training and drills undertaken by the assigned rescue personnel.
    - This must be noted both on the Entry Permit itself and the rescue plan attached to the Permit.
  - Emergency service availability.
    - Members of the rescue team must be trained in basic First Aid and CPR and at least one member must have current certifications available. Telephone numbers for the nearest medical facility and other emergency services must also be readily available onsite for immediate use.
  - Method of preventing unauthorized personnel from attempting a rescue.
  - A Safety Data Sheet (SDS) for any possible substance exposures that will need to be made available to the medical facility treating an exposed Authorized Entrant.
- Plan for and use a non-entry rescue method for a Standard Entry into a Permit Required Confined Space. This requirement may only be waived if the configuration of the Confined Space and entry point makes this type of rescue impossible (e.g., internal barriers), increases the overall risk of the entry (e.g., tangled lines, difficult access/egress), or would not contribute to the rescue. This will require:
  - Each Entrant to wear a full body harness with a retrieval line attached at the center of the back near the shoulders or above the head.
  - Wristlets instead of a full body harness if it can be demonstrated that a full body harness is infeasible or creates a greater hazard and the use of wristlets is the safest and most effective alternative.
  - The outside end of the retrieval line attached to a mechanical device or fixed point outside the Confined Space to allow for an immediate rescue attempt.
  - A mechanical retrieval device for any vertical entry into Confined Space more than 1.5 m (5 ft.) deep.
- Obtain the applicable permits if the work inside the Confined Space involves “Hot Work”, entry into an IDLH atmosphere, or other types of work with heightened risk from the Company.

### 5.9.5 Valve Pit and Vault Entry

The special provisions for valve pit and vault entries shall only be applied in the following circumstances:

- The valve pits and vaults have been designed for human entry for inspection purposes or other operational duties.
- The only potential hazard that could arise would be a hazardous atmosphere due to gas handling equipment failure.
- There are no other “confined space hazards” such as entrapment or engulfment or other serious hazardous conditions.
- The work is limited to operations such as routine inspection or maintenance or emergency response (i.e., not opening gas handling equipment to atmosphere).
- If a valve pit and vault entry meet the above requirements, the following steps must be applied:
  - The atmosphere inside the pit or vault must be tested prior to entry to determine it is safe using a gas monitor with hose (i.e., entry is not required to complete an accurate test). These atmosphere readings must be logged.
    - This may be captured using a Confined Space Entry Permit (with a notation that this is a valve pit / vault entry and not a permitted entry).
  - The entrant must wear a Personal Gas Monitor (PGM) while inside the space and exit immediately if the atmosphere becomes hazardous.
- If the valve pit or vault entry does not meet the above requirements or during entry the atmosphere becomes hazardous, an assessment of the space shall be conducted, and standard confined space entry practices as outlined above must be followed.

### 5.9.6 Concluding Entry Operations

Conduct the following activities as part of concluding entry operations:

- Ensure all Authorized Entrants have exited the Confined Space.
- Return the Confined Space to its normal mode (including closing, barricading, and/or adding signage as appropriate).
- Have Entry Supervisor debrief all participants (Attendant and Authorized Entrants) to capture the following information:
  - Recap of planned activities.
  - Successes of controls and Entry and any challenges or issues encountered regarding or within the Confined Space.
  - Discrepancies or changes from original planned work.
  - Final status / configuration at the project completion.
- Debrief Contractor personnel at the end of entry operations regarding procedures and any hazards confronted or created during entry operations and documents findings.
- Document all issues identified on or attached to the Entry Permit.

### **Contractors shall ensure that Workers:**

### ***Entry Supervisor***

- Contractor Entry Supervisor is established for entry, and they shall:
  - Sign off on Confined Space Transfer of Control to Contractor to accept responsibility for subsequent entry activities.
  - Confirm with Company Person in Charge (PIC) that all anticipated preparation activities and documented controls have been completed and implemented.
  - Confirm all pre-entry rescue preparation is complete including equipment deployed and personnel on appropriate standby.
  - Complete or confirm any forms, worksheets, or checklists as required to confirm the confined space meets the requirement for an Alternate Entry Procedure or entry as a Non-Permit Required Confined Space.
  - Know the space-specific hazards including:
    - Acceptable atmosphere levels for explosive gases or vapors, oxygen, and toxic substances.
    - The mode, signs, and symptoms of exposure to potential substances in the confined space.
- Verify correct completion of the Confined Space Entry Permit, including ensuring per-entry atmospheric testing is completed and provides expected results.
- Sign the Entry Permit prior to Authorized Entrants entering the Confined Space.
- Terminate the Entry and cancels the Entry Permit when:
  - Entry operations covered by the permit have been completed.
  - A condition that is not allowed under the permit arises in or near the Confined Space.
- Remove any Unauthorized Person who enters or attempts to enter the Confined Space during Entry operations.
- Whenever responsibility for an Entry operation is transferred and at intervals dictated by the hazards and operations performed within the space, the Entry Supervisor must determine that Entry operations comply with the requirements of the Entry permit and that acceptable Entry conditions are maintained.

### **Authorized Entrant shall:**

- Have completed Contractor Confined Space Entry program training.
- Be essential to the work planned within the Confined Space and has been authorized by the Entry Supervisor prior to entry.
- Know:
  - The hazards presented by the confined space being entered.
  - The mode, signs, symptoms, and consequences of exposure to potential substances in the confined space.
  - The proper use of all required PPE, monitoring equipment, and other safety equipment.
  - The system used to communicate with the Attendant.

- Wear all required PPE (as communicated by the Entry Supervisor) including any respiratory protection and harness with lifeline attached (as appropriate).
- Be considered to have entered a permitted confined space once any part of his body has broken the plane.
- Exit the permit space when ordered to evacuate and when a prohibited hazardous condition is recognized. In the event of exiting due to hazardous conditions arising, the entrant would also:
  - Immediately communicate this to Attendant/Safety Watch.
  - Await determination if the permit is deemed void and a new one is issued before re-entry.

**Attendant shall:**

- Have completed Contractor Confined Space Entry program training and specifically the training associated with the duties of an attendant.
- Be authorized by the Entry Supervisor to fulfill this role.
- Remain stationed outside the access opening of the Confined Space while it is occupied.
- Always maintain communications with entrants.
  - If the job does not allow the Attendant to be in visual contact with the Entrant(s), then prearranged lifeline signals or radios must be used.
- Maintain an accurate count of entrants.
- Know:
  - The hazards presented by the confined space being entered.
  - The mode, signs, symptoms, and consequences of exposure to potential substances in the confined space.
- Monitor the atmosphere and physical hazards as per the Entry plan and Confined Space Entry Permit requirements.
- Alert Workers of hazardous conditions or a change in conditions.
- Initiate evacuation and rescue procedures.
- May perform a non-entry rescue as per the rescue plan.
- Not perform duties that might interfere with the primary duty to monitor and protect the authorized entrants.
- Is empowered to:
  - Refuse unauthorized entry into the permit space
  - Direct entrants to evacuate the permit space
- Not leave his/her post until another attendant has been briefed and taken over the duties.

**Rescue Team Personnel shall:**

- Be trained in the Confined Space Entry program, including requirements of an Authorized Entrant as well as their assigned rescue duties and responsibilities.
- Be trained on required PPE and rescue equipment for the Entry being conducted.
- Be trained in basic first aid and CPR. At least one member must have current certifications available.
- Participate in Confined Space rescue drills at least once every 12 months.

- Be Informed of hazards they may experience when called to perform a Confined Space rescue.
- Provide with access to and information for all Confined Spaces which may require rescue to allow for the development of an appropriate rescue plan and practice rescue operations.
- Participate in the development or sufficiently review the rescue plan prior to Entry.

## 5.10 Crane and Hoist Safety

### **Contractors shall ensure that:**

- All Serious and Critical Lifts must be performed in accordance with the *Serious and Critical Lifts* section.
- Adhere to safe material handling section of these standards when appropriate to lifting with a crane. See 4.33 Material Handling and Storage section of these standards.
- Only designated personnel shall be permitted to operate a crane.
- Crane operation and operators are required to adhere to CSA or OSHA crane regulations.
- Contractor complies with the manufacturer's specifications and limitations applicable to the operation of all cranes and derricks.
- Rated load capacities, and recommended operating speeds, special hazard warnings, or instruction, shall be conspicuously posted on all equipment.
- Do not attempt to lift loads that exceed the rated capacity of the crane, hoist or lifting slings, rope, or chains. Remember, the smaller the angle on the legs of slings or chains, the less lifting capacity.
- An accessible fire extinguisher of 5BC rating, or higher, shall be available at all operator stations or cabs of equipment.
- Baskets used for personnel lifting will be designed and stamped by a certified Professional Engineer.
- Only trained and authorized personnel are permitted to operate hoisting equipment.
- Standing or riding on material hoists, crane blocks or crane loads is prohibited.

### **Inspections and Maintenance**

- Inspections of the hoisting equipment shall be made by a Qualified Person.
- All rigging equipment shall be inspected before each use.
- Records of all formal safety inspections will be retained.
- Inspections, based on manufacturer's recommendations shall be completed prior to each use and on regular intervals.
- For equipment in normal service (Normal Service involves operation of lifting equipment with a randomly distributed load within the rated load limit or uniform load of less than (<) 65% of rated load limit for no more than 25% of the time for a normal work shift.), inspect at least once per year, or as specified by the manufacturer.
- For equipment in heavy service (Heavy Service involves operation of lifting equipment within the safe working load that exceeds normal service.), inspect at least every 6 months, or as specified by the manufacturer.
- For equipment that is idle for 6 months or more, a full formal inspection prior to use.
- All maintenance repairs and routine service records will be retained.

- All damage repairs to the lifting boom, once completed, will be inspected, and approved by a registered engineer.

**Table 4: Minimum Clearance Distances (US)**

VOLTAGE (NOMINAL, KV, ALTERNATING CURRENT)	MINIMUM CLEARANCE DISTANCE (FT)
Up to 50	10
Over 50 to 200	15
Over 200 to 350	20
Over 350 to 500	25
Over 500 to 750	35
Over 750 to 1,000	45
Over 1,000	(As established by the utility owner / operator or registered professional engineer who is a qualified person with respect to electrical power transmission and distribution)

*NOTE: The value that follows “to” is up to and includes that value. For example, over 50 to 200 means up to and including 200kV. [75 FR 48142, August 9, 2010]*

**Hoisting and Mechanical Lifting**

- The operator of hoisting equipment is responsible for the safe lift and shall determine whether the load to be lifted is within the capacity of the hoisting equipment and that the appropriate lifting device (i.e., chain, choker, sling, or bridle) is used.
- Hoisting equipment should be inspected before it is put into use, and it should be tested before being used on heavy loads.
- Approved hand signals will be reviewed and used. A copy of the hand signal chart must be posted where the crane or hoist is used.
- The operator and signal person must carefully observe the position of power cables, piping, valves, pipelines, etc. before initiating the lift.
- The hoisting machine operator must keep his/her attention on the person giving the signals. The signal person must always keep his/her attention on the load.
- Synthetic slings are preferred to be used for hoisting rather than chains.
- Cables and fabric slings should be protected with pads or blocks where they are placed around sharp edges.
- Tag lines shall be used to control load swing, rotation and/or balance, when necessary, to prevent a hazard to Workers. When the bottom of the load is waist high or lower, tag lines are not required, but can be used if additional stability is desired.
- U-bolt clamps shall have the U-bolt on the deadline.
- Ropes should be used for lifting lightweight containers and other minor weight bearing activities, such as use as a tag line.
- Ropes contaminated with oil, grease or chemicals should be properly discarded.



- When lifting pipe or any smooth-surfaced materials, slings (bridles and chokers) should be placed around the object with at least two turns or fastened choker fashion.
- Materials or equipment should not be left hanging on a hoist indefinitely. The item should be blocked and the tension on the lifting device slowly relieved after making sure the blocking or cribbing will support the load.
- Portable hoist, come-along, chain falls, and binders shall be visually inspected before each use to determine the condition of the operating mechanisms, chains, ropes, cables, and the hooks. The rated load capacity of the portable lifting devices shall be marked and clearly legible.

### **Slings – Safe Operating Practices**

- Whenever any sling is used, the following practices shall be observed:
  - Each day before use, the sling and all fastenings and attachments shall be inspected for damage by a competent person designated by the Contractor. Additional inspections shall be performed during use, where service conditions warrant.
  - Damaged or defective slings shall not be used and shall be immediately removed from service.
  - All slings should be stored in a well-ventilated, dry building or shed. Never store them on the ground or allow them to be continuously exposed to the elements because this will make them vulnerable to corrosion and rust.
  - Slings shall not be loaded more than their rated capacities.
  - Slings shall be securely attached to their loads.
  - Slings shall be padded or protected from the sharp edges of their loads.
  - A sling shall not be pulled from under the load when the load is resting on the sling.
  - Slings shall not be shortened with knots or bolts or other makeshift devices.
  - Sling legs shall not be kinked.
  - Slings used in a basket hitch shall have the loads balanced to prevent slippage.
  - Suspended loads shall be kept clear of all obstructions.
  - Hands or fingers shall not be placed between the sling and its load while the sling is being tightened around the load.
  - Shock loading is prohibited.

### **Alloy Chain Slings**

- All alloy chain slings must have permanently attached durable identification. The identification must include the size, grade, rated capacity, and reach.
- Prior to use, any alloy chain sling that is new, repaired, or reconditioned must be proof tested by the sling manufacturer or equivalent entity. A copy of the certificate of proof testing must be maintained and available for examination.
- Hooks, rings, oblong links, pear shaped links, welded or mechanical coupling links or other attachments must have a rated capacity at least equal to that of the alloy steel chain with which they are used, or the sling shall not be used more than the rated capacity of the weakest component.
- Alloy steel chain slings must not be used with loads more than the rated capacities prescribed in (OSHA's *Guidance on Safe Sling Use 'Tables and Figures'*)
- If the chain size at any point of any link is less than that stated in OSHA's *Guidance on Safe Sling Use 'Tables and Figures'*, the sling must be removed from service.

**Table 6: Rated Capacity (Working Load Limit), for Alloy Steel Chain Slings (in lbs.)**  
(Horizontal angles shown in parentheses)

CHAIN SIZE (INCHES)	SINGLE BRANCH SLING-90° LOADING	DOUBLE SLING VERTICAL ANGLE (1)			TRIPLE AND QUADRUPLE SLING (3) VERTICAL ANGLE (1)		
		30° (60°)	45° (45°)	60° (30°)	30° (60°)	45° (45°)	60° (30°)
1/4	3,250	5,650	4,550	3,250	8,400	6,800	4,900
3/8	6,600	11,400	9,300	6,600	17,000	14,000	9,900
1/2	11,250	19,500	15,900	11,250	29,000	24,000	17,000
5/8	16,500	28,500	23,300	16,500	43,000	35,000	24,500
3/4	23,000	39,800	32,500	23,000	59,500	48,500	34,500
7/8	28,750	49,800	40,600	28,750	74,500	61,000	43,000
1	38,750	67,100	5,800	38,750	101,000	82,000	58,000
1 1/8	44,500	77,000	63,000	44,500	115,500	94,500	66,500
1 1/4	57,500	99,500	61,000	57,500	149,000	121,500	86,000
1 3/8	67,000	116,000	94,000	67,000	174,000	141,000	100,500
1 1/2	80,000	138,000	112,900	80,000	207,000	169,000	119,500
1 3/4	100,000	172,000	140,000	100,000	258,000	210,000	150,000

NOTES: (1) Rating of multileg slings adjusted for angle of loading measured as the included angle between the inclined leg and the vertical.  
 (2) Rating of multileg slings adjusted for angle of loading between the inclined leg and the horizontal plane of the load  
 (3) Quadruple sling rating is same as triple sling because normal lifting practice may not distribute load uniformly to all 4 legs.

**Table 7: Minimum Allowable Chain Size at Any Point of Link**

CHAIN SIZE (INCHES)	MINIMUM ALLOWABLE CHAIN SIZE (INCHES)	CHAIN SIZE (INCHES)	MINIMUM ALLOWABLE CHAIN SIZE (INCHES)
1/4	13/64	1	13/16
3/8	19/64	1 1/8	29/32
1/2	25/64	1 1/4	1
5/8	31/64	1 3/8	1 3/32
3/4	19/32	1 1/2	1 3/16
7/8	45/64	1 3/4	1 13/32

- Alloy steel chain slings with cracked or deformed master links, coupling links or other components must be removed from service.
- Slings must be removed from service if hooks are cracked, have been opened more than fifteen percent (15%) of the normal throat opening measured at the narrowest point or twisted more than ten degrees (10°) from the plane of the unbent hook.

- In addition to the “before each use” visual inspection required for all slings, a written periodic inspection of alloy chain slings must be made at least once every 12 months or more often, dependent upon use, conditions, and service.
- Clean and inspect the chain so that defects would be visible.
  - Twists or bends
  - Nicks or gouges
  - Excessive wear or stretching
  - Distorted or damaged master links, coupling links, or attachments.
  - Defective Welds
- The periodic inspection must be documented and be available for examination. The record must include the most recent month and year the inspection was performed.

### **Wire Rope**

- Wire rope slings shall not be used with loads that exceed the manufacturer’s rated capacities. Rating tables are shown in OSHA’s *Guidance on Safe Sling Use ‘Tables and Figures’*. Slings not included in these tables shall be used only in accordance with the manufacturer’s recommendations.
- Wire rope slings shall have permanently affixed and legible identification markings identifying the SWL, type(s) of hitch(s) used, the angle upon which it is based, and the number of legs if more than one.
- The following are minimum lengths for slings:
  - Cable laid and 6x19 and 6x37 slings must have a minimum clear length of wire rope 10 times the component rope diameter between splices, sleeves, or end fittings
  - Braided slings must have a minimum clear length of wire rope 40 times the component rope diameter between the loops or end fittings
  - Cable laid grommets, strand laid grommets and endless slings must have a minimum circumferential length of 96 times their body diameter
- Wire rope slings shall be immediately removed from service if any of the following conditions are present:
  - Ten randomly distributed broken wires in one rope lay, or five broken wires in one strand in one rope lay.
  - Wear or scraping of one-third the original diameter of outside individual wires.
  - Kinking, crushing, bird caging or any other damage resulting in distortion of the wire rope structure.
  - Evidence of heat damage.
  - End attachments that are cracked, deformed, or worn.
  - Hooks that have been opened more than 15 percent of the normal throat opening measured at the narrowest point or twisted more than 10 degrees from the plane of the unbent hook.
  - Corrosion of the rope or end attachments.

### **Synthetic Web Slings**

- Each sling shall be marked or coded to show:
  - Name or trademark of the manufacturer.

- The rated capacities for each type of hitch and type of synthetic web material.
  - Rated capacity shall not exceed.
- Synthetic webbing shall be of uniform thickness and width and selvage edges shall not be split from the webbing's width.
- Fittings shall be:
  - Of a minimum breaking strength equal to that of the sling; and
  - Free of all sharp edges that could in any way damage the webbing.
- Stitching shall be the only method used to attach end fittings to webbing and to form eyes. The thread shall be in an even pattern and contain enough stitches to develop the full breaking strength of the sling.
- Synthetic web slings shall not be used with loads more than the rated capacities specified by the manufacturer or in OSHA's *Guidance on Safe Sling Use 'Tables and Figures'*.
- When synthetic web slings are used, the following precautions shall be taken:
  - Nylon web slings shall not be used where fumes, vapors, sprays, mists, or liquids of acids are present.
  - Polyester and polypropylene web slings shall not be used where fumes, vapors, sprays, mists, or liquids of caustics are present.
  - Web slings with aluminum fittings shall not be used where fumes, vapors, sprays, mists, or liquids of caustics are present.
- Synthetic web slings must be immediately removed from service if any of the following conditions are present:
  - Acid or caustic burns.
  - Melting or charring of any part of the sling surface.
  - Snags, punctures, tears, or cuts.
  - Broken or worn stitches.
  - Distortion of fittings.

### **Hooks**

- At least annually, hooks shall be visually inspected by a qualified person.
- Hooks found to have any of the following conditions shall be removed from service:
  - Bending, deformation or twisting exceeding 10 degrees from the plane of the unbent hook.
  - Distortion in the Throat opening of a hook causing an increase in the throat opening exceeding 15%.

### **Contractors shall ensure that Workers:**

- Operator will not leave his/her position at the controls while a load is suspended from the hoist.
- Loads shall not be handled by any equipment beyond the capacity specified in the manufacturer's chart.
- When handling heavy loads with pneumatic-tire mobile cranes or auto cranes which are provided with outriggers, the outriggers should be out on solid ground or good blocking and the machine on solid ground or mats.

- Check the area of lift and travel prior to the lift to ensure personnel are notified and in safe positions and the area is clear of obstructions.
- No persons will be allowed to ride the hook or load.
- Wear personal protective equipment needed during hoisting operations.
- Loads will be securely connected and balanced prior to lifting.
- Do not lift with kinks or twists in the wire rope or chains.
- Proper padding, blocking, and protective devices will be used to avoid sling damage.
- All Workers shall be kept clear of loads about to be lifted and of suspended loads.

## 5.11 Critical and Serious Lifts

### 5.11.1 Critical Lift

Company considers the following operations Critical Lifts:

- Any load handling equipment lift, when the load is greater than 75% of the manufacturer's rating chart,
- Any tandem lift (multi-crane lift) involving two or more lifting devices lifting the same load simultaneously,
- Any lift where the load travels over or between overhead High Voltage power lines (this does not include cables in cable trays), and
- Any lift that is deemed a Critical Lift by the operator, supervisor, management personnel, or Health & Safety personnel.

### 5.11.2 Serious Lift:

Company considers the following operations Serious Lifts:

- Crane lift where workers are being hoisted in a man-basket,
- Lift where failure of the lift could endanger existing Facilities of one-of-a-kind equipment or processes,
- Load where non-routine lifting or rigging equipment configurations are used,
- Lift where the load or any part of the load handling equipment could come within the safe limits of approach to High Voltage equipment or a power line,
- Lifts over existing permanent structures or operating equipment, and
- Blind lifts.

### Contractors shall ensure that:

- Serious or Critical Lifts will be performed in accordance with all applicable regulatory and company requirements.
- Serious or Critical Lifts shall not be performed when environmental conditions create an additional hazard (lightning, wind exceeding manufacturer's recommendations, etc.)
- Power lines are presumed to be energized unless the utility owner / operator confirms that the power line is de-energized, continues to be de-energized and is visibly grounded at the worksite. Minimum clearance distances are listed in the table, in section 4.5 Boom Truck and Rigging.
- For Lifts performed near electrical power lines or distribution lines, no part of the crane, rigging or load must be allowed to come within the safe clearance distance from power lines
- If so equipped, crane limits must be set and verified prior to performing the lift.
- All Serious or Critical Lifts must have a Lift Plan. *GTM Critical Lift Plan Template*. or approved contractor form must be completed and approved by the Person in Charge (PIC) prior to beginning the Serious or Critical Lift.
- 3<sup>rd</sup> party Contractor(s) who perform lifting activities for Company shall create and follow their own written Lift Plan for performing the task. When 3<sup>rd</sup> party contractors develop the Lift Plan, their documentation can be used in lieu of GTM Critical Lift Plan Template.

- The person developing the Lift Plan **must**:
  - have received formal crane operation training or recertification within the last five years
  - be familiar with and understand the limits of the lifting equipment that will be used
  - understand and be able to address the potential hazards of the lift including rigging (length, capacity, angles, spreader bar(s), etc.), load (weight, size, bulk, abnormal shape, multiple attachment points, etc.), adjacent vehicle traffic, communication, weather, work environment and load travel path
  - consult with Company Technical Staff only if engineering support is required (Company engineers are not responsible for developing the Lift Plan, only providing engineering support as needed)
- For serious and critical lifts, the minimum control measure required shall be completion of a lift plan. The lift plan shall be reviewed, agreed to, and signed off by all workers involved in the lift at the pre-lift meeting.
  - At a minimum, the information recorded on the Serious Lift Plan shall include:
    - Weight,
    - Radius,
    - Equipment type,
    - Percentage of load chart,
    - Rigging components,
    - Rating capacities, and
    - Adequate clearances to prevent contact with site-specific hazard(s) or obstructions during load handling activities.
  - In addition to the requirements of the Serious Lift Plan, the Critical Lift Plan shall include:
    - Equipment layout and swing path schematic,
    - Rig arrangement schematic, and
    - Lift sequence.

### **Lifting Personnel**

- A boom truck or mobile crane shall not be used to lift personnel unless other means such as scaffolds, ladders, aerial lifts etc. would be more hazardous or not possible due to the structural design or layout of the workplace.
- Personnel being lifted shall wear all required PPE. See PPE Section.
- The Man Basket must pass inspection by a competent person at the beginning of each shift before lifting any personnel.
- A trial lift with the unoccupied Man Basket loaded at least to the anticipated Lift weight shall be made from ground level, or any other location where workers will enter the platform to each location at which the Man Basket is to be hoisted and positioned. [Source: 1926.1431(h)(1)]
- Operator shall not exceed 50 percent of the equipment's rated capacity at any time during the lifting of personnel. [Source: 1926.1431(h)(3)(iv)]

- Operator shall not hoist workers while crane is traveling, except where equipment travels on fixed rails; or it can be demonstrated that there is no less hazardous way to perform the work. [Source: 1926.1431(k)(12)(i)]
- When the Man Basket is in a stationary working position, all brakes (load, boom, swing, secondary, pawls, dogs, etc.) must be engaged.

### **Engineered Lift Plan**

- Engineers developing an engineered lift plan must consult with the manufacturer of the crane, hoist or derrick that will be used for the lift.
- Each engineered lift must utilize a separate Engineered Lift Plan.
- Each engineered lift must comply with regulatory requirements including *ASME NOG-1-2015*.

### **Contractors shall ensure that Workers:**

- All involved personnel must attend a pre-lift meeting to discuss the Lift Plan, JSA, Lift Hazard Area and any areas of concern. Personnel that did not attend the pre-lift meeting are prohibited from being in the Lift Hazard Area during a Serious or Critical Lift.
- Understand and follow the requirements of the Lift Plan.
- Ensure that Company participants are made aware of the contractor's Lift Plan.
- Company personnel working with the contractor must abide by the requirements and limitations of the contractor's Lift Plan.
- JSA must be completed prior to beginning the Serious or Critical Lift.
- Crane Operator and Signal Person must discuss and agree to the signals that will be used to direct the Lift.
- Tag line(s) must be used. They must be adequately sized and sufficient in quantity to control load swing, rotation and/or balance, to prevent a hazard to workers.



## 5.12 Electrical Safety

### **Contractors shall ensure that:**

- If overhead power line voltages are unknown, a Qualified Electrical Worker or Utility Owner shall determine the voltages and the Limited Approach Boundary and shall take appropriate action to make the work area safe.
- When the initial voltage test results indicate a voltage reading greater than 15V for above ground piping or 50V for below ground piping, the mitigation must be performed under the supervision of Qualified Electrical Worker.
- Workers shall not place themselves or operate equipment within the Limited Approach Boundary of overhead power lines. As shown in the table, the Limited Approach Boundary is 3 m (10 ft.) for systems up to 50 kV.
- For work within 6 m (20 ft.) of the Limited Approach Boundary of overhead power lines (see figure below), follow these requirements:
  - Site orientations, pre-job meetings, and daily tailgate meetings shall discuss assessed Hazards, SWPs and location(s) of the overhead power lines.
  - Workers shall be informed of the identified Hazards and any Control measures or precautions, in accordance with the Hazard Assessment.
  - A Signaler/Spotter shall be used when Workers and/or equipment are in proximity to the Limited Approach Boundary.
  - Delivery truck operators shall be cautioned about any overhead power lines present, and a Signaler/Spotter shall assist with loading or unloading operations (as appropriate, other vehicle operators shall be similarly cautioned, e.g., high vehicles)
  - Warning decals shall be posted on cranes and similar equipment, regarding the 3 m (10 ft.) minimum clearance.
  - Delivery or other vehicles that have emptied their material (e.g., dump trucks) shall not be permitted to leave the work location until the boom, lift or box is down and safely secured.
  - Vehicles with loads higher than 4.3 m (14 ft.) shall follow specific procedures to maintain safe working clearances when in transit below overhead power lines.
  - Warning cones / goal posts shall be used as visible indicators of the 3 m (10 ft.) Limited Approach Boundary. A safe work area shall be established before work commences. (See figure below)
- Workers shall maintain the Limited Approach Boundaries outlined in the table below. These boundaries apply to Workers as noted, including their work involving tools, vehicles, or equipment.
- A designated Signaler or Spotter shall ensure the minimum safe distances (i.e., Limited Approach Boundaries, sometimes referred to as safe limits of approach) are maintained by all Workers and equipment in the area. As part of this duty, the designated Signaler/Spotter shall monitor movements of all Workers, tools, and equipment when work is in progress near Energized lines.
- Performing Structure to Soil Potential testing are OQ task qualified.

**Table 8: Limited Approach Boundaries**

VOLTAGE OF POWER LINE OR CONDUCTOR		MIN. SAFE LIMITED APPROACH BOUNDARY	
PHASE TO GROUND AC VOLTAGE	PHASE TO PHASE AC VOLTAGE	NON-QUALIFIED WORKERS	QUALIFIED ELECTRICAL WORKERS
425–12,000	735–20,780	3.0 m (10 ft.)	0.9 m (3 ft.)
12,000–22,000	20,780–38,105	3.0 m (10 ft.)	1.2 m (4 ft.)
22,000–50,000	38,105–86,600	3.0 m (10 ft.)	1.5 m (5 ft.)
50,000–90,000	86,600–155,880	4.5 m (15 ft.)	1.8 m (6 ft.)
90,000–120,000	155,880–207,845	4.5 m (15 ft.)	2.1 m (7 ft.)
120,000–150,000	207,845–259,805	6.0 m (20 ft.)	2.7 m (9 ft.)
150,000–250,000	259,805–433,010	6.0 m (20 ft.)	3.3 m (11 ft.)
250,000–300,000	433,010–519,615	7.5 m (25 ft.)	3.9 m (13 ft.)
300,000–350,000	519,615–606,215	7.5 m (25 ft.)	4.5 m (15 ft.) </td
350,000–400,000	606,215–692,820	9.0 m (30 ft.)	5.4 m (18 ft.)

**Table 9: Approach Boundaries to Energized Electrical Conductors or Circuit Parts for Shock Protection, Direct-Current Voltage Systems**

(1)	(2)		(4)
NOMINAL VOLTAGE CONDUCTOR TO GROUND	LIMITED APPROACH BOUNDARY		RESTRICTED APPROACH BOUNDARY (INCLUDES INADVERTENT MOVEMENT ADDER)
	EXPOSED MOVABLE CONDUCTOR	EXPOSED FIXED CIRCUIT PART	
Less than 100V	Not specified	Not specified	Not specified
100V – 300V	3.0m (10ft 0 in)	1.0m (3ft 6in)	Avoid contact
301V – 1 kV	3.0m (10ft 0 in)	1.0m (3ft 6in)	0.3m (1ft 0in)
1.1 kV – 5kV	3.0m (10ft 0 in)	1.5m (5ft 0in)	0.4m (1ft 5in)
5.1 kV – 15 kV	3.0m (10ft 0 in)	1.5m (5ft 0in)	0.7m (2ft 2in)
15.1 kV – 45 kV	3.0m (10ft 0 in)	2.5m (8ft 0in)	0.8m (2ft 9in)
45.1 kV – 75 kV	3.0m (10ft 0 in)	2.5m (8ft 0in)	1.0m (3ft 2in)
75.1 kV – 150 kV	3.3 m (10ft 8 in.)	3.0 m (10ft 0 in.)	1.2 m (4ft 0 in.)
150.1 kV–250 kV	3.6 m (11ft 8 in.)	3.6 m (11ft 8 in.)	1.6 m (5ft 3 in.)
250.1 kV–500 kV	6.0 m (20ft 0 in.)	6.0 m (20ft 0 in.)	3.5 m (11ft 6 in.)
500.1 kV–800 kV	8.0 m (26ft 0 in.)	8.0 m (26ft 0 in.)	5.0 m (16ft 5 in.)

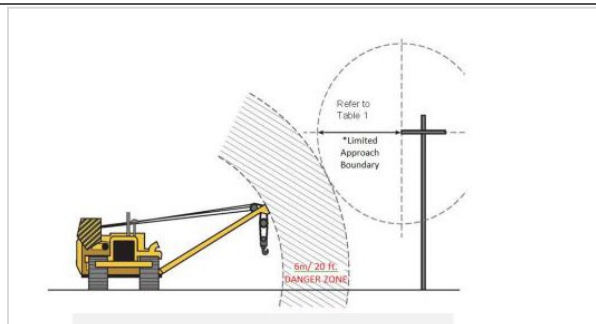

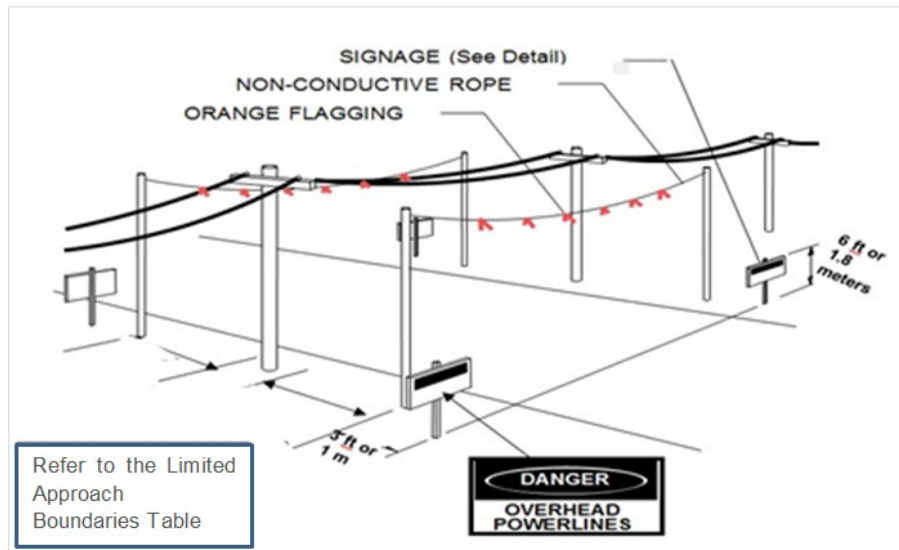

**Figure 7: Typical Goal Post Setup**

- Cheater cords (pigtails with electrical outlets) must be inspected by a Qualified Electrician and that a safe work permit is issued prior to use.
- Any cheater cords that are field-fabricated must be inspected by an electrician to ensure the cord is safe to use before first use.
- The electrician will attach a label to each cheater cord that clearly identifies the date of inspection.
- Any cord suspected of having any defects or damage shall not be used.
  - The electrician will destroy and dispose of any extension cord or cheater cord that is not safe to use.

**When used in hazardous/classified areas:**

- The Worker will identify the cheater cord on the safe work permit.
- The Worker will inform the permit issuer that they will be using a cheater cord.
- The permit issuer will review the safe work permit with the Worker using the cheater cord.
- Connect the non-explosion proof ends of the cord and the equipment being powered first and locked or taped together securely so they will not inadvertently pull apart, then connect the explosion proof plug-in.
- When disconnecting, the explosion proof plug must be removed first and then all other connections can be disconnected.
- The permit issuer will visit the work area to ensure that hazards have been identified and mitigated.
- All plugs-in must be disconnected at the end of the permit.

## 5.13 Excavation and Trenching Safety

### Contractors shall ensure that:

- Company personnel, Company Inspector or approved Company representative shall be on site when excavation activity occurs within 4.5 m (15 ft.) of the Company facility.
- Before work begins, contact the PIC responsible for the workplace.
- Before beginning the excavation, the site must be evaluated for the following potential hazards:
  - Buried pipelines and utilities,
  - Vehicle and heavy machinery traffic,
  - Nearby structures,
  - Previously disturbed soil,
  - Possibility of a hazardous atmosphere.
- Pre-planning must be done to determine the following:
  - Will personnel be working in the excavation?
  - What is the soil classification?
  - **In the USA**, If the soils are not classified, Type C soil shall be used with a maximum allowable slope of 1 ½ to 1
  - What will be the depth and dimensions of excavation?
  - Will the location require shoring or shielding equipment due to limited space?
- A work plan identifying special provisions will be required when an excavation is:
  - over 6 m (20 ft.) in depth, or
  - in a swamp or muskeg, or
  - in an area where proper sloping cannot be achieved, or
- The location of sewer, telephone, fuel, electric, and water lines as well as any other underground installations that may be encountered during excavation work must be located and marked prior to opening the excavation.
- Arrangements must be made as necessary by the Competent Person with the appropriate utility agency for the protection, removal, shutdown, or relocation of underground installations.
- Contact the state “one call” center no less than 48 hours before beginning any excavation, trenching, boring or other soil disturbing activity except in emergencies.
- Call the pipeline or utility company at the telephone number shown on the marker.
- Wait for the third-party pipeline or utility to send a representative to mark the exact location and route of the pipeline or utility.
- All facilities inside the dig area and facilities within 5 m (16.5 ft.) of the dig area must be surfaced located and staked or flagged.
- If it is not possible to establish the exact location of underground installations, the work may proceed with caution using special detection equipment or other safe and acceptable means (e.g., hand tools, probes, hydrovac).
- Company representative shall be present to supervise mechanical excavation within 60 cm (24 in) of the top, bottom, or sides of a pipe.
- Excavation work will be conducted in a manner that does not endanger underground installations or Workers engaged in the work.

- Any excavation, regardless of depth, that has unstable, sloughing, or flowing soil must be sloped, shored, or shielded.
- Before personnel enter an excavation, that is 1.2 m (4 ft.) deep or more, the Competent Person must assess the excavation to ensure that an approved protection system is being used unless the excavation is in stable rock as determined by the Competent Person.
- A competent person shall determine the degree to which the actual slope must be reduced below the maximum allowable slope where surcharge loads from stored material or equipment, operating equipment, or traffic are present.
- The slope and configuration of sloping and benching systems shall be selected and when constructed will conform to the recognized engineering standards.
- The design of support systems, shield systems, and other protective systems shall be selected and constructed in accordance with all the recognized engineering standards.
- The size, type, and configuration(s) of the material to be used in the protective system must be identified in the design.
- A copy of the design must remain at the excavation site until the excavation is complete.
- The maximum height of any bench is 1.2 m (4 ft.). Bench widths should be as follows:
  - Workers are allowed on the bench: the width of the bench must be a minimum of 1.5 times the height of the bench.
  - Workers not allowed on the bench: A bench can have a minimum width equal to the height of the bench.
- Contractor shall maintain a written log of all excavation inspections conducted. This log shall include the date, worksite location, results of the inspection, and a summary of any action taken to correct existing hazards.
- Adequate protection must be provided to protect Workers from loose rock or soil that could pose a hazard by falling or rolling from an excavation face. Such protection will consist of:
  - Scaling to remove loose material.
  - Installation of protective barricades, such as wire mesh or timber, at appropriate intervals on the face of the slope to stop and contain falling material.
  - Benching sufficient to contain falling material.
  - Using restraining devices that are sufficient to prevent materials or equipment from falling or rolling into excavations.
  - Materials piled, grouped, or stacked near the edge of an excavation must be stable and self-supporting.
- Support systems (such as shoring, bracing, or underpinning) must be used to assure the stability of structures and the protection of Workers where excavation operations could affect the stability of adjoining buildings, walls, or other structures.
- Excavation below the level of the base or footing of any foundation or retaining wall that could be reasonably expected to pose a hazard to Workers will not be permitted except when:
  - A support system, such as underpinning, is provided to ensure the safety of Workers and the stability of the structure; or
  - The excavation is in stable rock; or
  - A competent person has approved the determination that the structure is sufficient for use in excavation

- o A competent person has approved the determination that such excavation work will not pose a hazard to Workers.

**Table 10: Sloping Requirements Based on Soil Types**

SOIL TYPE*	SOIL QUALITIES	EXAMPLES OF SOILS	SLOPE OR BENCH** ANGLE	ANGLE EXAMPLE
Rock	Solid mineral matter	Stable granite, sandstone etc.	90 degrees	
Type A**	Cohesive with compressive strength of 1.5 ton per square foot (tsf) or greater	Clay, Silty clay (1), Sandy clay, Clay loam (2), Caliche.	53 degrees ¾H:1V	
Type B**	Cohesive with compressive strength >0.5 tsf but <1.5 tsf, granular cohesion less soils	Angular gravel (similar to crushed rock), silt, silt loam, sandy loam and, in some cases, silty clay loam, sandy clay loam. Also soils that would otherwise be 'Type A' but are fissured or subject to vibration.	45 Degrees 1H:1V	
Type C	Cohesive with compressive strength <0.5 tsf, granular soils	Granular, soft, sandy or loose soils including gravel, sand, and loamy sand; or submerged soil or soil from which water is freely seeping, or submerged rock that is not stable.	34 degrees 1.5H:1V	

**NOTES:**

- (1) Silt is loose sedimentary material with rock particles.
- (2) Loam is a mixture of mostly moist clay with some sand and silt.
- (\*) If the soil is not classified, Type C soil shall be used.
- (\*\*) Benching is only allowed in soil classified as Type A or B.

- Where oxygen deficiency, toxic or flammable atmosphere exists or has the potential to exist, the atmosphere must be tested before workers approach the excavation to begin work and must be monitored continuously while workers are inside the excavation.

- Atmospheric testing must be conducted in excavations over 1.2 m (4 ft.) deep where hazardous atmospheres could reasonably be expected to exist (e.g., landfill areas, near hazardous substance storage, gas pipelines).
- Atmospheric monitoring will be performed using a properly calibrated direct reading instrument with audible and visual alarms. Monitoring will be continuous where ventilation controls are used to reduce the level of atmospheric contaminants.
- Monitors will be maintained and calibrated in accordance with manufacturer's specifications.
- Workers are not allowed to intentionally work in a known flammable atmosphere – a flammable gas/vapor concentration of 10% LEL or greater of its lower explosive limit (LEL).
- Forced ventilation or other effective means will be used to prevent exposure to an atmosphere containing a flammable gas.
- Unauthorized entry into a hazardous atmospheric environment is strictly prohibited which includes entering an excavation with blowing gas.
- Utilities on the site must be protected and suitable precautions taken if any utility will be disturbed by the work.
- Utilities left in place must be protected by barricades, shoring, suspension, or other means.
- Work that may impact existing utilities that may need to be locked and tagged out using procedures from the Lockout/Tagout Program.
- All equipment, materials, supplies, permanent installations (e.g., buildings, roadways), trees, brush, boulders, and other objects at the surface that could present a hazard to Workers that are working in the excavation must be removed or supported, as necessary, to protect Workers.
- All surface obstructions that will create a hazard to workers must be removed or supported as necessary.
- Traffic around the site must be controlled, and barricades, signs, and/or flag persons used as needed to control both vehicular and pedestrian traffic.
- When mobile equipment is operated adjacent to the edge of an excavation, a warning system will be used when the operator does not have a clear and direct view of the edge of the excavation.
- The warning system must consist of barricades, hand, or mechanical signals, or stop logs
- Workers must wear reflective vests if working in a high traffic area.
- A toothless excavator bucket or a bucket with a tooth guard is required when excavating all Company pipelines as well as when the Company is crossing another Company's pipeline.
- No pile driving operations or any other construction operations that could affect the integrity of the excavation will be permitted near or around the excavation while Workers are in the excavation.
- If personnel are trapped by a cave-in, the following should be performed immediately:
  - Initiate emergency response plan
  - Call 911 or the local emergency services as quickly as possible
  - Never dig out a victim with heavy equipment
- Do not enter the excavation to perform rescue until the walls are stabilized
- Excavations must not be left open any longer than needed after the job task has been completed.

- Backfilling must proceed together with the removal of support systems and in a manner that will prevent Worker exposure to the hazards associated with excavations.
- Where Workers are required or permitted to cross over the excavation, walkways, or bridges with standard guard rails and toe boards must be provided.
- Workers will not work in excavations that contain or are accumulating water unless precautions have been taken to protect workers from hazards posed by water accumulation.
- If water is controlled or prevented from accumulating by using water removal equipment, the water removal equipment and operation must be monitored by a person trained in the use of the equipment.
- If excavation work interrupts the natural drainage of surface water (such as streams), diversion ditches, dikes, or other suitable means will be used to prevent surface water from entering the excavation. Precautions will also be taken to provide adequate drainage of the area adjacent to the excavation.

### **Contractors shall ensure that Workers:**

- Competent person will conduct daily inspections of excavations, adjacent areas, and protective systems for evidence of a situation that could result in possible cave-ins, failure of protective systems, hazardous atmospheres, or other hazardous conditions.
- An inspection shall be conducted prior to the start of work and as needed throughout the shift. Inspections shall also be made after each hazard changing event (e.g., rainstorm).
- These inspections are required when the excavation will be or is occupied by Workers.
- All open excavations left unattended must be barricaded and marked for easy recognition.
  - The only exception to this could be pipeline trenching.
- When working in the excavation, all workers must remain within the protective system.
- Stairs, ladders, or ramps must be provided where Workers are required to enter trench excavations that are 1.2 m (4 ft.) or more in depth.
- The maximum distance of travel in an excavation to a means of egress must not exceed 7.6 m (25 ft.).
- Ladders must extend at least 1 m (3 ft.) above the top of the excavation and must be secured against movement and slippage.
- Ingress and egress must never be performed using a backhoe or any excavating equipment.
- If the equipment operator does not have a clear and direct view of the edge of the excavation, a warning system, such as barricades, hand signals, or stop logs will be used.
- No Worker will be permitted underneath loads handled by lifting or excavation equipment.
- Workers will be required to stand away from any vehicle being loaded or unloaded.
- No digging, lifting, or hauling equipment will be operated within the 'minimum distances' from the edge of the excavation while workers are in the excavation. Minimum distances are listed in the table below – Minimum Distance for Materials from Edge of Excavation.
- Excavated material must be stacked such that it will not create a hazard to the Workers in the excavation.
- The minimum distance that materials shall be kept from the edge of an excavation is described in the table below.



**Table 11: Minimum Distance for Materials from Edge of Excavation**

<b>AREA</b>	<b>MINIMUM DISTANCE REQUIREMENT</b>
• USA	• 60 cm (2 ft.)

## 5.14 Fall Protection

Company defines a fall hazard as:

- 1.2 m (4 ft.) or more above a lower level from a *Permanent* walking/working surface (horizontal and vertical surface) or
- 1.8 m (6 ft.) or more above a lower level from a *Temporary* walking/working surface (e.g., construction activities) or
- Any fall where there is an unusual possibility of injury (e.g., falling through an opening in a work surface)

### **Contractors shall ensure that:**

- Potential fall hazards are evaluated and controlled.
- Where Fall Arrest is used, a rescue plan will be established, written, reviewed, and communicated.
- The written plan shall include provisions for rescue of Workers in the event of a fall or ensure that Workers are able to rescue themselves.
- Appropriately applied Fall Restraint does not require a written rescue plan
  - Rescue considerations will vary according to the situation but may be as simple as having another person present when fall restraint is being used.
- Workers shall be protected from a fall or injury related to a fall, by either:
  - Elimination or Substitution (e.g., move work to ground level)
  - Guardrails
  - Control Zones
  - Personal Fall Restraint Systems (PFRS)
  - Personal Fall Arrest Systems (PFAS)
  - Safety Net System
  - Other system(s) designed by an engineer
- Fall protection systems may include one or more of the following:
  - Guardrails with mid-rails and toe boards
  - Covers for holes in floors, roofs, and other walking/working surfaces
  - Personal Fall ‘Arrest’ System or Personal Fall ‘Restraint’ System
  - Positioning device system
  - Control zones
  - Protection from falling objects
- Examples of situations where fall protection may be required include, but are not limited to:
  - Unprotected sides and edges.
  - Hoist areas or shafts.
  - Ramps, runways, and other walkways (except for Workers working on permanent walkways, work platforms or tank landings equipped with top and mid-rails and toe boards).
  - Excavations if not sloped.
  - Near dangerous equipment.
  - Wall openings (a gap or void, 75 cm (30 in) or more in height, and 30 cm (12 in) or more in width through which Workers can fall to a lower level).

- Incomplete scaffolds / work platforms.
  - Open top vessels, tanks, or roof of a building.
  - Crane baskets.
  - Personnel lift (aerial work platform or Elevated Work Platform).
  - Where three points of contact cannot be maintained on ladders without an enclosure.
- ANSI / CSA approved safety lines (vertical or horizontal lifelines) may be used for fall restraint or fall arrest.
  - Independently secure safety lines to approved structures of adequate strength.
  - Use softeners where lines attach to structures and elsewhere as necessary to protect against chafing or abrasion from contact with sharp edges.
- Only approved lanyards are utilized to secure workers wearing a full body harness to an approved vertical or horizontal lifeline or fixed anchor point.
  - Lanyards shall be rated for 5,000 lbs. (22.2 kN), with double action snap hooks, and secured above the point of operation.
  - Shock-absorbing lanyards are required when using a PFAS system
  - Where used for fall protection, lanyards must not permit a worker to fall more than 1.2 m (4 ft.) vertically.
  - Ropes and straps (webbing) used in components of the body harnesses, lanyards and lifelines shall be made from synthetic fibers.
  - Where lanyards are used for horizontal work restraint, suitably anchor lanyards to prevent wearers from slipping over a roof edge.
- Safety Belts are only permitted when used for horizontal Fall Restraint (applies when using ANSI / CSA approved waist-type safety belts, with safety lines).
- SRLs that limit free fall to less than 0.6 m (2 ft.) shall be rated for a minimum of 3,000 lbs. (13.3 KN).
- SRLs that do not limit free fall to less than 0.6 m (2 ft.) shall be rated for a minimum of 5,000 lbs. (22.2 KN).
- Equipment anchorage, tie-off, and use must meet the following conditions:
  - Anchoring points must be permanently fixed objects
  - Engineered anchor points, used in PFAS, must be able to support at least 5,000 lbs. (22.2 kN) for each attached Worker
  - Non-engineered anchor points, used for attaching PFAS, must be a sound and stable structure
  - When tying off, the Worker must tie off at a location where there are no obstacles in the potential path of a fall (including any obstacle in a swing fall)
  - The Worker must follow the anchoring tie off and equipment tie off procedures that are specified by the fall protection system manufacturer prior to getting into a position where they could fall.
- Where an engineered anchor point option is available it must be used.
- Engineered anchor points must be inspected by a qualified person annually or as specified by the manufacturer.

- The manufacturer's procedures for the equipment must be followed. In addition, personal fall arrest equipment must comply with the following:
  - Harnesses must be attached in the center of the back near shoulder level, above the wearer's head
  - Personal fall arrest systems must limit the maximum arresting force on a Worker to 1,800 lbs. (8 kN)
  - Systems must bring a Worker to a complete stop and limit maximum deceleration distance a Worker travels to 1 m (3.5 ft.); and
  - Systems must have sufficient strength to withstand twice the potential impact energy of a Worker free falling 1.8 m (6 ft.), or the free fall distance permitted by the system, whichever is less.
  - Systems must be rigged in such a way that a Worker can neither free fall more than 1.8 m (6 ft.), nor contact any lower level.
- Periodic inspections include an annual inspection or as specified by the manufacturer, shall be conducted by a qualified person, and documented.
- Follow the manufacturer's instructions and training protocols for equipment maintenance, cleaning, and storage.
  - Do not store webbing and rope lanyards in direct sunlight.
  - Storage areas should be clean, dry, and free of exposure to fumes or corrosive elements.
  - Periodic cleaning of properly maintained fall protection equipment is necessary. Consult the manufacturer's guidance for additional instruction on cleaning and maintenance.
- Defective equipment shall be removed from service immediately and destroyed or discarded. Notify the responsible Supervisor before the end of the work shift.
- Fall protection equipment subjected to impact loading shall be immediately removed from service and inspected by a qualified person and discarded where appropriate.
- Pre-use inspection of Vertical and Horizontal Lifelines:
- Is intended to identify excessive wear, damage, and deterioration. Inspections should include but not be limited to:
  - Energy absorber (condition)
  - Anchor points
  - Cable/rail condition
  - Grabs (as applicable)
  - Connecting hardware

**Contractors shall ensure that Workers:**

- Wear a PFAS or PFRS when working within 2 m (6.5 ft.) or less of a Fall Hazard, except when working in the following situations:
  - Permanent platforms enclosed by guardrails, providing work activities do not extend outside of guardrails.

- Temporary scaffolding and walking surfaces protected by guardrails, providing work activities do not extend outside of guardrails.
  - Fixed cage ladders.
  - Portable ladders – where three points of contact can be maintained on ladders.
- Utilize a Full Body Harness for arrest or restraint.
- Are expected to consult with a Supervisor or competent person when the Worker is uncertain about the anchoring point he/she should use.
- Pre-use inspection of fall protection equipment (harness and lanyards) by the user shall be completed to identify excessive wear, damage and deterioration and should include but not be limited to:
  - Cuts, cracks, tears, frays, broken strands, enlarged grommets, and other signs of wear that might affect strength in lanyards, belts, and lifelines. There shall be no additional punched holes.
  - Stitching and materials for degradation and evidence of corrosion due to contact with acids, caustics, welding holes, splatter, etc.
  - Metal hardware for breaks, cracks, fractures, loose anchorage, distortion, and corrosion.
  - Check D-rings and D-ring metal wear pads for distortion, cracks, breaks, and rough or sharp edges. The D-ring bar should be at a 90-degree angle with the long axis of the belt and should pivot freely.
  - Note any unusual wear, frayed, or cut fibers, or distortion of the buckles.
  - Rivets should be tight and unmovable with fingers.
  - Body side rivet base and outside rivets should be flat against the material.
    - Bent rivets will fail under stress.
  - Failing hook latches, absence of locking latches, or a change in shape of the metal.
    - The snap hook load indicator is in the swivel of the snap hook.
    - The swivel eye will elongate and expose a red area when subjected to fall arresting forces.
    - Do not use the unit if the load impact indicator has been activated.
  - Lifeline unit housing for loose fasteners and bent, cracked, distorted, worn, malfunctioning or damaged parts.
- Pre-use inspection of Self-Retracting Lifelines (SRLs) by the user shall be completed to identify excessive wear, damage, and deterioration. Inspections should include but not be limited to:
  - Retraction and tension shall be tested by pulling out several feet of the lifeline and allowing it to retract back into the unit.
  - Always maintain a light tension on the lifeline as it retracts.
  - The lifeline should pull out freely and retract all the way back into the unit.
  - Do not use the unit if the lifeline does not retract.
  - Braking Mechanism Inspection:
    - Test for slippage of the lifeline while the brake(s) is engaged.

- Release tension to ensure the brake(s) will disengage, and the unit will return to the retractable mode.
- Do not use the unit if the brakes do not engage.
- All personnel working from an AWP shall wear fall restraint equipment including an approved safety harness and lifeline tied off to the manufacturer identified anchor point. The lifeline shall be a fixed or retractable length to prevent the operator from extending over the edge of the platform.
  - Workers shall not anchor to an adjacent pole, structure, or equipment when working from an aerial lift.

Unless specified by the manufacturer, handrails are not tie off points on the platform. Normal safety harness tie-off points are identified on the aerial lift.

## 5.15 Fatigue Management

### **Contractors shall ensure that:**

- A fatigue management plan is implemented when Workers are at an increased risk from the effects of fatigue. Examples of working conditions that may warrant a fatigue management plan include:
  - Workers will be working extended length of shifts worked (12 hours not including travel time)
  - Workers will be working (shifts) beyond 12 consecutive days
  - Workers travel time to and from the Worksite (total work day, including travel, exceeds 14 hours)
  - excessive physical effort is required as part of normal work activity
  - environmental extremes are anticipated (e.g., heat, cold, noise, vibration, lighting)
- The Fatigue management plan should consider the following:
  - identification of the factors that lead to Fatigue
  - assessment of the risks associated with the factors that contribute to Fatigue
  - identification of control measures to manage exposure to Fatigue
  - implementation of the selected control measures
  - rehabilitation / return to work
  - management approval processes
- Advanced notice is provided to the Company Representative of work that falls under the Fatigue management plan.
- Contractors comply with the appropriate, State, Federal or Provincial Employment Standards regarding hours of work.
- Update Project Management of Worker fatigue status.

### **Exceptions:**

- Responding to Emergencies
- Workers responding to an initial emergency (including callouts) are exempt to allow sufficient staffing to safely sustain an effective response.
- During this period, Contractor will use sound judgment and maintain a watchful eye on the Workers' behavior.
- As soon as practical the supervisor shall establish a sustained work plan.

## 5.16 Flammable and Combustible Materials

### Contractors shall ensure that:

- Adequate precautions shall be taken to prevent the ignition of flammable vapors.
- Sources of ignition shall be controlled.
- Open flames and smoking are not permitted in flammable or combustible liquid storage areas.
- Avoid storing flammable or combustible liquids in areas exposed to heat which may pressurize its container.
- Substances that may cause combustion when combined with flammable or combustible liquids shall not be stored near flammable or combustible liquids.
- Safe types of mechanical air movers, explosion-proof electrical equipment, and static-grounded connections will be used when working in areas where flammable vapors or gases may exist.
- If using a contracted carrier, the carrier must, at all times, hold the appropriate approval from the aviation authority in order to transport hazardous or dangerous goods by air for the Company.
  - The pilot in command MUST be informed of any dangerous goods cargo before the start of the flight.
- Use DOT-approved containers when shipping samples by commercial carrier.
- Do not carry standard safety cans with gasoline or other flammable liquids in passenger or luggage space of vehicles.
- Fire extinguishers shall be available at locations where flammable or combustible liquids are stored.
- Do not store materials that will react with water in the same room with flammable or combustible liquids.
- The application of air pressure or compressed gas to any flammable / combustible liquid container (can, barrel or drum), for any purpose, is strictly prohibited.
- Flammable or combustible liquids and aerosol cans shall be stored in approved cabinets or in a separate building used only for that purpose. The building should be at least 15 m (50 ft.) from compressor buildings unless the exposed wall has a two-hour (2-hr) fire rating.
- Cabinets shall be Underwriter Laboratories (UL) listed and/or Factory Mutual (FM) approved, which is indicated by a permanent manufacturer's label on the cabinet.
- Approved cabinets should be vented outside of the building, if possible. If ambient temperature outside would cause freezing, vent approved cabinet inside of building.
- Storage cabinets must meet the requirements for design, construction, and capacity. This includes:
  - Not more than 60 gal (227 L) of Class I or Class II liquids, not more than 120 gal (454 L) of Class III liquids may be stored in a storage cabinet.
  - Storage cabinets shall be designed and constructed to limit the internal temperature to not more than 325°F when subjected to a 10-minute fire test.
  - All joints and seams shall remain tight, and the door shall remain securely closed during the fire test.
  - Cabinets shall be labeled in conspicuous lettering, "Flammable-Keep Fire Away."



- Metal Cabinets shall be constructed in the following manner:
  - The bottom, top, door, and sides of cabinet shall be at least No. 18 gage sheet iron and double walled with 3.8 cm (1½-in) air space.
  - Joints shall be riveted, welded, or made tight by some equally effective means.
  - The door shall be provided with a three-point lock, and the door sill shall be raised at least 5 cm (2 in) above the bottom of the cabinet.
- Wooden Cabinets shall be constructed in the following manner:
  - The bottom, sides, and top shall be constructed of an approved grade of plywood at least 2.5 cm (1 in) in thickness, which shall not break down or delaminate under fire conditions.
  - All joints shall be rabbeted and shall be fastened in two directions with flathead woodscrews.
  - When more than one door is used, there shall be a rabbeted overlap of not less than 2.5 cm (1 in).
  - Hinges shall be mounted in such a manner as not to lose their holding capacity due to loosening or burning out of the screws when subjected to the fire test.
- Storage tanks must comply with the SPCC Plan as appropriate.
- Storage tanks must be labeled to properly identify the contents and chemical identity.
- This Section applies only to the storage of flammable or combustible liquids in drums or other containers (including flammable aerosols) not exceeding 60 gal (227 L) individual capacity and those portable tanks not exceeding 660 gal (2498 L) individual capacity.
  - Storage of flammable or combustible liquids in open containers shall not be permitted.
  - Barrels and containers for flammable liquids shall be sealed after each use and when empty.
  - Class I flammable and Class II combustible liquids shall be stored in approved safety containers of not more than 5-gal (19 L) capacity.
  - The approved safety cans shall be stored in approved cabinets in minimum quantities or in a separate building used for that purpose.
  - Portable tanks must be provided with one or more devices installed in the top with sufficient emergency venting capacity to limit internal pressure under fire exposure conditions to 10 psig, or 30 percent of the bursting pressure of the tank, whichever is greater.
  - Flammable or combustible liquids should be shielded from direct sunlight, and away from heat sources.
  - Flammable and combustible liquid containers must be in accordance with the sizes listed in the table below, except that glass or plastic containers of no more than 1-gal (3.8 L) capacity may be used for a Class IA or IB flammable liquid.

**Table 12: Maximum Allowable Size for Containers and Portable Tanks**

CONTAINER TYPE	FLAMMABLE LIQUIDS			COMBUSTIBLE LIQUIDS	
	CLASS IA	CLASS IB	CLASS IC	CLASS II	CLASS III
Glass or approved plastic	1 pint	1 qt	1 gal	1 gal	1 gal
Metal (Other than DOT drums)	1 gal	5 gal	5 gal	5 gal	5 gal
Safety cans	2 gal	5 gal	5 gal	5 gal	5 gal
Metal drums (DOT specifications)	60 gal	60 gal	60 gal	60 gal	60 gal
Approved portable tanks	660 gal	660 gal	660 gal	660 gal	660 gal

**Contractors shall ensure that Workers:**

- Review SDS of flammable or combustible product to determine the correct class prior to product use.
- Wear appropriate hand protection (identified on the SDS) when working with commercial solvents, gasoline, and carbon tetrachloride.
- Do not use gasoline or carbon tetrachloride as a cleaning or degreasing agent.
- Remove defective equipment or containers from service immediately.
- Use and maintain adequate ventilation to remove flammable vapors when painting or using solvents.
- Observe the following safe practices and procedures to minimize exposure and to control hazards when using solvents:
  - Store and dispense all flammable cleaners in approved safety cans.
  - Contaminated rags shall be stored and disposed in an approved manner.
- Ground and bonded dispensing and receiving containers during transfers.
- Transport flammable liquids in standard safety cans with spring-loaded vents.
- Flammable liquid containers contents shall be marked by the manufacturer or stenciled, plainly visible, on the side or top of the container.
- Promptly dispose of rags soaked in kerosene, mineral spirits or other flammable fluids.
- Keep contaminated rags in self-closing metal labeled containers until they can be disposed of.
- Store bales of rags and burlap sacks in well-ventilated, waterproof, non-combustible type buildings, and in such a manner as to allow air to circulate between individual bales. The bales shall be stored where they do not receive the direct rays of the sun through windows, and at a safe distance from any other source of ignitions, and a safe distance from flammable or combustible liquids.

## 5.17 General Equipment Safety

### **Contractors shall ensure that:**

- General hand tools will be kept in good condition and used for their intended purpose. Worn or damaged hand tools shall be taken out of service and replaced.
- Power tools that come equipped with the manufacturer's point of operation guards shall not be operated with the guards removed. The manufacturer's specification guide will list the proper guard requirements and operational settings for any attachment.
- Scaffolds must be erected, moved, altered or dismantled under the direction of a competent person.
- The scaffold shall have a signed and dated inspection / acceptance tag filled out by a competent person and attached to it before use.
- Power tools that are not double insulated will require a ground fault protection device be used with them.
- All hooks used on lifting devices shall be equipped with a self-closing safety latch.
- All rotating equipment shall be guarded with a fixed shield at the open points of rotation. This fixed guarding requirement includes bench grinders, table saws, and any shaft driven, or belt driven rotating equipment.
- Store high pressure hoses indoors or in a PVC container, out of sunlight such that they are UV protected.
- Inspect visually tools and equipment prior to every use.
- Re-certification shall be performed as required by the manufacturer's guidelines.
- Frequency of replacement is dependent upon use.
- Additional machine guarding shall be provided for any nip points, flying chips or sparks. The guards shall be constructed so that it does not create a hazard when operating the equipment.
- Air hoses used for compressed air to drive portable air tools shall be in good condition and pressure rated for the provided air pressure service. Air tool attachments shall be rated for that air pressure service and attached to the air tool with a retainer.

### **Contractors shall ensure that Workers:**

- Properly store portable ladders when not in use.
- Shall not use portable metal ladders in or around electrical equipment.
- Visually inspect:
  - Ladders prior to use and if found defective taken out of service.
  - Portable hoist, come-along, chain falls, and binders before each use to determine the condition of the operating mechanisms, chains, ropes, cables, and the hooks. The rated load capacity of the portable lifting devices shall be marked and clearly legible.
  - Wire rope chokers and synthetic slings before each use and taken out of service if any wear indicators are visible. Wire rope chokers and synthetic slings are manufactured to close tolerances and shall be properly cleaned and stored after each use.
  - Alloy steel chains for cracked or deformed links before each use.

## 5.18 General Office Safety

### **Contractors shall ensure that:**

- Office Workers participate in safety training as per contractor's policies.
- Aisles and hallways shall provide unobstructed movement and immediate access to emergency exits and to fire protection equipment.
- Regular maintenance of the lighting system should include cleaning the fixtures, replacing blinking or dim bulbs and repairing faulty lamp circuits.
- Those who work with potentially hazardous chemicals or substances receive Hazard Communication training annually and receive job specific training from their Supervisor.
- Office personnel going to field locations are aware of the training and PPE requirements for a field visit if required.

### **Contractors shall ensure that Workers:**

- Keep all passageways, entryways, aisles, storerooms, service rooms and work areas clean, orderly, sanitary and well maintained, with no obstructions.
- Check for raised or unsecured floor tiles to prevent tripping hazards.
- Properly position a chair before sitting down and once seated, always keep at least one foot and all chair legs on the floor.
- Do not roll across the floor while sitting in a chair and do not lean sideways from a chair to pick up an object.
- Use only stools or stepladders to reach materials stored above eye level. Chairs are unacceptable to use as climbing devices.
- Utilize rolling stools and ladders that are equipped with brakes that operate automatically when weight is applied.
- Do not operate office machines with moving parts, high temperature hazards, and electrical shock potential without proper safeguards in place.
- Disconnect (unplug) the power source before trying to remove jammed materials from a machine.
- Do not pull an electrical cord to shut off power to any equipment.
- Use of extension cords should be minimized and arranged to avoid tripping hazards and electrical overload.
- Keep food, drink and excessive combustible materials away from electrical equipment, computers or workstations. Damage to circuitry or destructive fires may result.
- Keep flammable or combustible material and residue in a building or operating area to a minimum. Store in metal safety cans or storage cabinets that meet Underwriters Laboratories, Inc. or Factory Mutual approval.
- Review the SDS prior to use of any chemical.
- Secure paper cutter blades in the down position when not in use.
- Store knives, thumbtacks, and other sharp objects in proper containers or with the blades and points covered or shielded. Secure edges before disposing these items.
- File drawers and desk drawers should not be left open and:
  - Do not overload top drawers so that files tip over.
  - Secure file cabinets and bookcases as appropriate.

- Keep heavy files in lower drawers.
- Do not open a file drawer if someone is working underneath.
- Secure or anchor file cabinets or bookcases taller than 162.5 cm (64 in) to the wall to prevent toppling over.
- Safely stack material/boxes to avoid creating a hazard.
- When moving equipment, furniture, or boxes, use proper carts, dollies, or trucks.
- When carrying material from one floor to another, use the elevator (as applicable) whenever possible.
- Use plywood to spread out the load when moving heavy loads across raised floors.
- When material must be carried, use proper lifting and carrying techniques.
- Physically challenged persons, with either a permanent or temporary physical condition, should notify the Fire Warden assigned to their floor or office, if applicable.
- Are familiar with the location of the fire alarm station (if applicable) nearest to your workstation or office, and with emergency procedures including the appropriate evacuation route for your workstation or office.

**During fire alarms:**

- Help the Fire Wardens by clearing the area quickly, and aid them if they request assistance
- If a Fire Warden requests you to leave an area, do so and close the door on the way out

**During evacuations:**

- Do not use elevators; use the stairways, following the nearest exit signs and evacuation drawings, if applicable.
- Remove high heels to avoid falling downstairs
- Check closed doors for temperature and smoke before opening

**Office Security:**

- All Workers must be alert to the preservation of office security, which includes prevention of unauthorized entry into the building and protection of the outside facilities.
- Keep all unattended doors and gates locked and report any strange activity to Supervision.

## 5.19 Hand and Portable Power Tools

### Contractors shall ensure that:

#### Requirements Related to All Hand and Portable Tools

- Inspect all tools, accessories and equipment for defects or other unsafe conditions prior to each use.
- No equipment or machine shall be operated unless the guards and protection (e.g., protective devices) are installed operating in accordance with their intended purpose, and properly maintained. Provide a method of machine guarding to protect Workers from Hazards created by point of operation, ingoing nip points, rotating parts, or other Hazards. Reference section 5.29 Machine and Equipment Guarding.
- Guards or other protective devices shall not be removed, defeated, bypassed or altered under any circumstances.
- Alert other personnel working in the area before using tools or equipment to prevent exposure to possible hazards.
- Report unsafe or defective tools and tag “DO NOT USE” until repaired or replaced.
- Tools shall not be placed in pockets or held in hands when climbing ladders. Use a strong bag, bucket, or similar container to hoist tools between the ground and the job.
- Tools shall be handed from one person to another, never thrown.
- Knives and other sharp tools shall be carried and stored in a safe manner with the sharp edge covered.
- Edged or pointed tools will be placed in carrying cases or with the handle toward the receiver.
- Machine-operated tools or equipment are never left running unattended.
- Decontaminate all hand and power tools that have been used in an environment where asbestos, lead, poisonous plants or other hazardous materials were present.
- The use of cheater bars or pipes (pipe extensions) is not considered a safe work practice and is not recommended.

#### Switches and controls

- All hand-held powered circular saws, having a blade diameter greater than 5 cm (2 in), electric, hydraulic or pneumatic chain saws, and percussion tools without positive accessory holding means shall be equipped with a constant pressure switch or control that will shut off the power when the pressure is released.
- All hand-held gasoline powered chain saws shall be equipped with a constant pressure throttle control that will shut off the power to the saw chain when the pressure is released.
- All hand-held powered drills, tappers, fastener drivers, horizontal, vertical, and angle grinders with wheels greater than 5 cm (2 in) in diameter, disc sanders with discs greater than 5 cm (2 in) in diameter, belt sanders, reciprocating saws, saber, scroll, and jig saws with blade shanks greater than a nominal 0.6 cm (¼-in), and other similarly operating powered tools shall be equipped with a constant pressure switch or control. These devices may have a lock-on control if turnoff can be accomplished by a single motion of the same finger or fingers that turn it on.
- All other hand-held powered tools, such as, but not limited to, platen sanders, grinders with wheels 5 cm (2 in) in diameter or less, disc sanders with discs 5 cm (2 in) in diameter or less, routers, planers, laminate trimmers, nibblers, shears, saber, scroll, and jig saws with blade

shanks a nominal 0.6 cm (1/4-in) wide or less, may be equipped with either a positive “ON-OFF” control, or other controls as described by the first two bullets above (i.e., first two bullets in this section).

### **Hand Tool Related**

- Open bladed work knives (does not apply to kitchen utensils)
- Open blade knives (e.g., locking blade utility knives) shall not be used unless a Hazard Assessment is completed to determine that alternate tools cannot be used to complete the task for which the open bladed knife is required. The Hazard Assessment shall review the scope of work, the cutting tool to be used and specific PPE (e.g., cut-resistant gloves or gauntlets).
- When it is determined that an open bladed knife is the only tool that can be used to complete a task the following criteria shall be met:
  - specific PPE shall always be worn when using an open bladed knife
  - material being cut is secure
  - approval is noted on any applicable SWPs
  - a working space appropriate to the task allows the Worker to work with the open bladed knife in a safe manner without endangering themselves or other
- A hammer or sledge must have a securely wedged handle suited to the type of head used. The handle will be smooth, free of oil, shaped to fit the hand, and of the correct size and length.
- Do not use a steel hammer on a hardened steel surface. Heads will be dressed whenever they start to check or mushroom.
- When sledges or other heavy hammers are used, the worker holding the tool being struck shall use a tool holder.
- Wooden or fiberglass handled tools should not be taped or painted to check for handle cracks, splinters or other defects. Cracked handles shall be replaced prior to use.
- The wooden handles of hand tools shall be kept free of splinters and/or cracks and will be kept tight.
- Impact tools, such as drift pins, wedges, and chisels, shall be kept free of mushroomed heads and splinters.
- Never use files without handles. Use files with a smooth, crack-free handle. Never clean by striking files against metal, use a file card.
- Keep chisels sharp and ground to a 60° angle. Chisel heads shall be dressed when they start to check or mushroom.
- Use hack saw blades recommended by the manufacturer appropriate to the type metal to be cut.
- Snips shall be heavy enough to cut the material with one hand on the snips. Protective gloves will be worn.
- Woodcutting tools with sharp edges or blades shall be used so that, if a slip occurs, the direction of force will not be toward the body.
- Protect sharp edges of woodcutting tools with a sheath or metal guard when not in use.
- Do not use open-end box wrenches with sprung or cracked jaws.
- Adjustable wrenches shall be “pulled,” not “pushed,” with the open jaw facing the user.
- Never strike a wrench with a hammer unless it is an approved hammer wrench.

- Do not use a wrench as a hammer.
- Screwdrivers shall not be used for punches, wedges, pinch bars, or pries.

### **Electric Energy Related Tools**

- Use approved electrical equipment to power the tools.
- Inspect equipment prior to use and ensure equipment is in safe operating condition with all manufacturer guards are in place.
- Immediately tag as defective and remove from service any electrical cords and plugs with mechanical damage, e. g., exposed wiring; cords with frayed or deteriorated insulation; bent or broken prong of a plug, etc.
- Only qualified electrical workers can:
  - Inspect or repair defective portable electrical equipment.
  - Cut or splice power cords or extension cords.
- Arrange temporary wiring for a power supply (e.g., where needed for portable electrical tools, equipment, and lighting units).
- Tool handles must be insulated when working on live circuits.
- Electric cords, equipment and tools will be properly grounded (or double insulated if applicable) and maintained in good condition.
- Extension cords are approved three-wire type, with appropriate Conductor insulation and an overall jacket not susceptible to damage at low temperatures.
- Cords are not permanently secured to any structure or used for hoisting tool.
- Power cords are elevated where possible, to prevent tripping Hazards or being damaged by vehicles / equipment.
- If an extension cord is to be used, keep the cords connection out of any standing water, and use a heavy-duty extension cord with components rated for use in wet locations.
- Store electrical equipment and cords to avoid damage (e.g., mechanical, thermal, UV exposure, etc.).
- Use Ground Fault-Circuit Interrupter (GFCI) protection when using portable tools outdoors or when water, moisture or wet conditions are encountered.
- Use approved ground-fault circuit interrupters for all 120-volt, single-phase, 15- and 20-ampere receptacle outlets which are not a part of the permanent wiring of the building or structure. Receptacles on the ends of extension cords are not part of the permanent wiring and shall be protected by GFCIs whether the extension cord is plugged into permanent wiring.
- Electric tools and equipment switches are in the OFF position before being plugged in.
- Unplug the tool when attaching or removing bits, blades or other accessories.
- Loosen and tighten drill chucks with a chuck key; not with pliers or a pipe wrench.
- In addition to the above, Workers shall also follow these requirements:
  - Unattended temporary electrical equipment (such as lights, heaters, etc.) that will be left on in a Hazardous Area or Restricted Area shall be approved and installed for Class 1, Div. 2 area classifications.
  - Metal measuring tapes, aluminum ladders, or ropes having metal threads woven into the fabric shall not be used near exposed, live electrical parts.



- Portable generators used on the worksite shall be grounded, in accordance with manufacturers' specifications.
- All voltage and current testers shall be rated for the circuits and equipment to which they are connected.
- Safety ground cables used in electrical cubicles and substations shall be stored in a central location.

### **Bench grinders**

- Bench grinders shall be bolted down to the work surface.
- Fixed grinding wheels wire buffing wheels shall have tool rests.
- The angular exposure of the grinding wheel periphery and sides for safety guards shall not exceed 90 degrees or one-fourth of the periphery.
- Inspect the following before each use of the bench grinder:
  - Look for loose bolts on the grinder base, flange and spindle guards.
  - Check the abrasive wheel for cracks and any other visual damage.
  - Check the tool rests and tongue guards and re-adjust to the maximum allowable distance from the wheels:
    - 0.6 cm (¼ in) for tongue guards.
    - 0.3 cm (⅛ in) for tool rests.
- Before installing a new abrasive wheel:
  - Perform a "ring test".
  - Check the abrasive wheel for the correct size and type for the grinder.
  - Also, check that the wheel is approved for more revolutions per minute (rpm) than the grinder.
- Do not use grinders to shape wood as sawdust clogs the pores of the grindstone, causing it to overheat, expand and rupture.
- Do not use the side of the wheel for grinding unless the stone is designed for side grinding.
- When operating a grinder, stand to the side when starting the grinder.

### **Portable Circular Saws**

- Equip portable, power-driven circular saws having a blade diameter greater than 5 cm (2 in) with guards above and below the base plate or shoe.
- The upper guard shall cover the saw to the depth of the teeth, except for the minimum arc required to allow proper retraction and contact with the work.
- When the tool is withdrawn from the work, the lower guard shall automatically and instantly return to covering position.

### **Pneumatic Energy Related Tools**

- Never point an air tool at another person.
- The manufacturer's safe operating pressure for hoses, pipes, valves, filters and other fittings shall not be exceeded. Adjust service air to manufacturer's specifications for tool to be used.
- Compressed air used for cleaning purposes shall be reduced to less than 30 psig.
- Compressed air must not be used to remove materials from skin or clothing.

- Only approved air nozzles are acceptable for use. Modification of nozzles is strictly prohibited.
- Do not use compressed air to clean workbenches or work areas.
- Set and maintain the air compressor regulators according to the manufacturer's instructions.
- Do not adjust pressure relief and regulating valves to allow the air compressor to operate above the manufacturer's recommended rating.
- All belts and pulleys are enclosed in a guard.
- Workers using compressed air equipment shall wear PPE and ensure the working area is cleared of other Workers. In addition, compressed air equipment shall:
  - include safety nozzles, plus effective chip guarding
  - never be used for cleaning Workers or their clothing
  - not exceed 30 psi when cleaning equipment or floors
  - not be adjusted to allow the compressor to operate above the manufacturer's specified rating
- Set the air supply properly for the tool being used.
- Shut off the air supply and drain the air prior to disconnecting tools.
- Safety restraints must be used to secure the tool to the hose.
  - AERO-Quip and other approved pressure activated retaining connectors may be used to meet this requirement.
- A safety clip or retainer must be installed to prevent attachments, such as chisels on a chipping hammer, from being unintentionally shot from the barrel.
- Compressed air guns should never be pointed toward anyone. Users should never "dead-end" it against themselves or anyone else.
- When utilizing air compressors to supply air movers, keep them outside the area where hazardous vapor concentrations exist and away from where they are exhausted.
- Ensure flow of induced air through annular orifice.
- Noise levels generated by an air mover may exceed permissible levels; use hearing protection for exposure over extended periods.
- Air movers shall not be shop-made / home-made.
- Nailers, staplers, etc., provided with automatic fastener feed and operating at more than 100 psig pressure at the tool shall have a safety device on the muzzle to prevent the tool from ejecting fasteners if not in contact with the work surface.

### **Air grinders**

- Operate air grinders at the manufacturer's recommended air pressure.
- Do not operate air grinders unless all manufacturers' guards are in place and working properly.

### **Air receivers (volume tanks):**

- Must be protected from over pressure with a safety relief valve which is tested at regular intervals.
  - Where a stop valve exists between a tank and safety valve, this shall be locked in an open position. A procedure shall be in place to ensure it is not left closed after maintenance/testing and that the pressure is constantly monitored while closed.
- Air receivers will have a drain and be checked periodically for accumulations of water/oil.

- Air receivers will be equipped with an indicating pressure gage.
- The tool's operating lever is properly functioning and is in the OFF position before attaching the air hose.
- When changing tools or parts, adjusting them, or when the tool is not in use, shut off and bleed down the air supply.

### **Chipping hammers and jackhammers**

- Make sure the tool bit is locked in place. If the tool bit does not lock, ensure it is in place before operating.
- Always keep a firm grip on the tool.

### **Impact wrenches:**

- If a locking mechanism is required, use a one-piece neoprene retaining ring when attaching a socket to a larger impact wrench.
- Before attempting to loosen or tighten a bolt or nut, check that the directional lever is in the correct position for the job.
- When installing a socket on larger impact wrenches, make sure the locking pin is in place and the rubber O-ring is firmly seated.
- Make sure assistance is available, and that operators have a firm footing and adequate working clearances (especially when operating larger impact wrenches).

### **Pneumatic hoses shall:**

- Be appropriately rated for the maximum pressure produced in systems.
- Have excess flow valves or chokes installed on all airlines at the compressor or header, to prevent high-volume air release.
- Not be used to raise and lower tools.
- Not be crimped to shut off the air supply, except in an emergency.
- Be checked periodically for wear or damage and replaced if necessary.
- If possible, be suspended from above to eliminate possible tangles, tripping hazards, unnecessary wear and damage by vehicles and carts.
- All hoses exceeding 1.3 cm (½-in) inside diameter shall have a safety device at the source of supply or a branch line to reduce pressure in case of hose failure.
- In addition, pneumatic hoses shall have temporary and quick connections secured, using whip checks on the following connection points:
  - compressor to hose
  - hose to hose
  - have safety pins where the connection point is designed for their use
  - have safety clips or retainers used at the attachment point on pneumatic impact percussion tools
  - be protected from tangles, unnecessary wear and damage

### **Chain saws**

- Before starting, inspect the saw for loose parts.
- Keep the chain sharp and inspect it for proper tension and condition,
- Start the saw at least 3 m (10 ft.) from the fueling area.
- When starting, always place the saw on the ground with one foot through the rear handle and one hand on the handlebar grip to hold securely.
- Never carrier the saw from place to place with it running.
- Always carry the chain saw with the bar pointed backwards.
- Never drop start a chain saw.
- When operating, maintain a firm grip on the saw with both hands.
- Always cut at high speed and do not cut with the nose or tip of the bar.
- Do not cut at heights above the shoulders.
- Do not stand directly in line with the chain (maintain sure footing).
- Do not cut while someone is standing in front of the cutting area.
- Keep the chain well oiled (oil reservoir is full).
- Fuel the chain saw in a well-ventilated area utilizing a funnel.
- Do not fuel while the engine is hot or running.
- Do not transport a chain saw in the vehicle cab.

### **Drum handling equipment**

- Use drum lifter to lift or lower a drum from an upright position, team lifting may be required when a drum lift is not available.
- Use a drum dolly to move a filled drum.

### **Fuel powered tools**

- Fuel powered tools, such as chain saws, water pumps, blow torches, etc., shall be stopped while being refueled, serviced, or maintained.
- Fuel shall be transported, handled, stored, and properly identified in approved containers.

### **Grinders and buffers**

- Workers using hand-held grinders and buffers shall:
  - not use the side of a wheel unless it is designed for side-grinding
  - stand to the side when starting the grinder, out of the line of fire
  - adopt a stance to one side of a steel wire wheel, where possible
  - unplug the tool when changing wheels or guards
  - not use the tool to shape wood
- A Qualified Worker shall check air grinders for maximum speed by dismantling the wheel and using a speed counter. If the speed exceeds the maximum revolutions per minute (rpm), reset the governor.
- Guards shall have a maximum exposure angle of 180 degrees and shall be located between operator and the wheel on right angle grinders.
- Prior to use, the grinder or buffer shall be inspected to ensure:

- the wheel is free of cracks
- the wheel does not vibrate excessively
- the buffing wheel has no loose wires or excess wear
- the disc is the correct size and type for the grinder, and is approved for more revolutions per minute (rpm) than the grinder
- all components are properly secured and in place
- all manufacturer's guards are in place, secure and not damaged
- there is no dead-man/locking switch (these are prohibited)

### **Hand Trucks**

- When using a hand truck, always face the direction the truck is heading.
- Hand trucks will be pushed rather than pulled when possible.
- Hand trucks will not be used to carry people.
- Hand trucks shall be inspected before each day's use.
- While descending a ramp or incline, the operator shall be on the uphill side of the hand truck.

### **Hydraulic power tools**

- The fluid used in such tools shall be fire resistant fluid and approved for use by the manufacturer of the tool.
- The manufacturer's safe operating pressures for hoses, valves, pipes, filters, and other fittings shall not be exceeded.

### **Jacks**

- Each jack shall be thoroughly inspected in accordance with the following:
  - For constant or intermittent use at one locality, prior to each use or at a minimum at least once every six months.
  - For jacks sent out of the shop for special work, when sent out and when returned.
  - For a jack subjected to abnormal load or shock, immediately before and immediately after.
- Jacks that are damaged or out of order shall be removed from use and tagged "DO NOT USE."
- The Operator shall make sure that the jack used has a rating sufficient to lift and sustain the load. (The requirement does not apply to engine barring jacks.)
- The rated load shall be legibly and permanently marked in a prominent location on the jacket by casting, stamping or other suitable means.
- Jacks shall have a positive stop to prevent over travel.
- A jack should only be used to lift a load, not support it.
- Hydraulic jacks exposed to freezing temperatures shall be supplied with adequate antifreeze liquid.
- In the absence of a firm foundation, the base of the jack shall be blocked. After the load has been raised, it shall be cribbed, blocked and secured.
- Jacks shall be properly lubricated at regular intervals. The lubricating instructions of the manufacturer shall be followed, and only recommended lubricants shall be used.

### **Mowers, blowers and weed eaters**

- Unplug electric powered mowers, weed eaters or blowers before cleaning, inspecting, adjusting or repairing the equipment.
- Do not clean, inspect, adjust or repair the equipment while the blades are in motion.
- Remove the ignition wire from the spark plug before reaching under mowers with hands.
- All guards and safety devices are in place and functioning properly.
- Inspect and remove small loose objects from the area that could become projectiles if struck by the blade or cable before starting the job.
- Mow across the face of the slope when mowing a slope or incline.
- Do not fuel the engine while it is running or while it is hot.

### **Post Pounders**

- Any work involving post pounders are required to have written procedures or job hazard analysis for the installation and removal of T-posts and must include:
  - Types of T-Post drivers and pullers approved by the Contractor
  - Safe removal of frozen or stuck t-posts
  - Condition of T-posts (free from excessive rust, straightness, etc.)
  - Requirement of a painted section near top of post for a visual indicator that the driver is being lifted too high.
  - Ground Disturbance requirements, if applicable
  - T-post spade to be driven in completely or removed
- The Design of the post pounder itself must be designed to address the risk of hand safety from the pounder coming off the post with effective Ergonomic principles applied.
  - Examples of this may be through manual post pounders having an elongated nozzle to make it unlikely that a worker could lift it over an upright post or through mechanical means such as slide hammers or air actuated hammers which guard the worker from moving the Cylinder.

### **Powder-Actuated tools**

- Only Workers who have been trained to operate a specific tool in use shall be allowed to operate a powder-actuated tool.
- The Operator of powder-actuated tools will wear hearing protection, safety goggles or other face and eye protective devices.
- The tool shall be tested each day before loading to see that safety devices are in proper working condition in accordance with the manufacturer's recommended procedure.
- Tools shall not be loaded until just prior to the intended firing time and loaded tools shall not be left unattended.
- At no time shall loaded or empty tools be pointed at Workers.
- Hands shall be kept clear of the open barrel end.
- Only powder-actuated charges, studs, pins, or fasteners designed and recommended for use in a specific tool by the tool manufacturer will be used.
- Fasteners shall not be driven into hard or brittle materials including but not limited to: cast iron, glazed tile, surface hardened steel, glass block, live rock, face brick or hollow tile.

- Driving into easily penetrated materials shall be avoided unless such materials are backed by a substance that will prevent the pin or fastener from passing completely through and creating a flying missile hazard on the other side.
- Tools shall not be used in an explosive or flammable atmosphere.
- Tools shall be used with the correct shield, guard or attachment recommended by the manufacturer.

### **Pressure washing and steam cleaning**

- The following PPE must be worn for each temperature range:
  - Up to 50° C or 120° F:
    - Safety glasses with side shields and face shields
  - 50° to 80° C or 120° to 180° F:
    - Safety glasses, face shield, rubber gloves, rubber boots and a slicker suit (the slicker suit trousers will always be worn over the boots)
  - 80° C or 180° F to boiling:
    - Wear a face shield, goggles, hard hat, rubber gloves, rubber boots and a slicker suit (the Operator must not have exposed skin.)
- All steam and water lines should be equipped with a check valve to prevent pressure from backing up into the cold-water system.
- Hose to pipe connections should always point downward and be installed as low as possible.
- Any water heater or steam generator shall be equipped with safety valves of the temperature-pressure type to accordance with the *ASME Boiler and Pressure Vessel Code*.
- Only use high-pressure armored or wire-reinforced steam hose.
- Hose connections shall be kept in good working condition.
- Nozzles should have insulating grips for coolness.
- Operators should always lead the hose out in a large loop so there are no turns or kinks.
- When hot water or steam is used near electrical equipment, the equipment should be completely covered if it is not moisture or weatherproof.
- To help prevent a spark when flammable vapors may be present, the nozzle should be grounded to the tank or container being cleaned.

## 5.20 Hazardous / Restricted Areas and Portable / Personal Gas Monitors

### Contractors shall ensure that:

- Provide (at their own expense) appropriate Atmospheric Monitoring and detection equipment unless otherwise noted within the bid documents or at the Request for Proposal (RFP).
- When necessary, specific atmospheric Hazard measurement devices shall also be provided by the Contractor, e.g., if mono-styrene, acetone, benzene or other Hazards are present. Company shall inform the Contractor when there is the potential for respiratory Hazards or contaminants that may not be detectable by standard 4-head monitors.
- Hazardous / Classified location shall be identified with the appropriate signage and shall be posted to ensure clarity for workers entering the area.
- Identification of hazardous locations shall also be reviewed as part of the work planning and execution process.
- As a normal course of business, Personal Communication Devices and Computers are not allowed in Classified Areas. However, where a genuine business need dictates, these devices may be used in a Classified Area provided the individual(s) utilizes a Personal / Portable Gas Monitor. These instances do not require a Hot Work Permit.
- Follow manufacturer's specifications regarding operation, servicing, bump testing and calibration.
- If an instrument fails a bump test or a calibration check, the Workers shall perform a full calibration on it before using it. If the instrument fails the full calibration, the Worker shall remove it from service.
- Functional bump testing shall:
  - be performed in accordance with the manufacturer's specifications before each day's use
  - for the mainline systems, use pentane or pentane equivalent gases; when pentane equivalent methane is used for calibration, then methane can be used for bump testing
  - for the vector system, use pentane or pentane equivalent gases for calibration, and methane for bump testing
  - When calibrated with pentane, a calibration gas with 0.35% pentane should be used to calibrate against 25% LEL. In this case, the default LEL setting should be set at 25% prior to applying the pentane calibration gas
  - when calibrated with pentane equivalent methane, a calibration gas with 2.5% methane should be used to calibrate against 50% LEL; in this case, the default LEL setting of portable gas monitors for calibration should be set at 50% prior to applying the pentane calibration gas
- Contractors shall maintain bump test and calibration logs at the Site and make the logs available at the request of the Company Representative.
- Workers who calibrate Gas Detectors shall:
  - calibrate to the frequency indicated in the manufacturer's specifications
  - bump test portable gas monitors and verify calibration before every Confined Space Entry



- attach a gas detector inspection tag to each gas monitor, including calibration date and initials of the Worker who calibrated the monitors; no tag is required if an auto-calibration station is used for personal multi-gas monitors; however, the Worker shall follow Company calibration requirements and the manufacturer’s specifications for calibration
  - tag the calibration record for multi-gas monitors and grab sampling equipment when shared with a group of Workers
  - record calibration results of manually calibrated portable gas monitors in the Gas Monitoring Instrument Service Log (either within Lotus Notes or other means) and retain as per the record retention requirements; it is not required to maintain a Gas Monitoring Instrument Service Log for portable gas monitors capable of self-monitoring calibration cycles indicating when calibration is required
  - All calibration and maintenance activities, including the Gas Monitoring Instrument Service Log shall be documented and retained according to the record retention requirements
- Use extreme caution during activities that may produce a source of ignition within hazardous classified location. Serious injury or death may occur.
  - Post “NO SMOKING” and equivalent signs to identify hazardous locations. Absence of such signs does not imply that the site is non-hazardous.
  - Motor vehicle spark producing equipment and ignition sources are not allowed in hazardous locations unless authorized. See Ignition Sources section for Positive Air Shut Off requirements.
  - When possible, locate equipment upwind of hazardous locations.
  - Smoking and lighting materials are prohibited in hazardous locations.
  - Smoking will be allowed only in designated and posted locations.
  - Spark controls shall be established where appropriate using blankets and/or fireproof enclosures.
  - PVC and other spark producing materials shall be removed from hazardous locations.
  - Where practicable, all combustible materials shall be removed from hazardous locations.
  - Only personnel performing and/or inspecting work during welding, cutting or other open flame operations can be in the immediate area of the work.
  - At least two dry chemical fire extinguishers shall be continuously available and manned during cutting or welding activities.
  - In the US, the extinguishers shall be two 30-lbs (14 kg) extinguishers.

**Table 11: Types of Monitoring Instruments**

HAZARD	MONITORING INSTRUMENT
H <sub>2</sub> S	Detector tubes and personal, portable, and stationary monitors
Benzene	Detector tubes and personal badges
CO	Portable monitors
Oxygen	Portable monitors
Combustible vapors and gases	Portable and stationary Lower Explosive Limit (LEL) monitors

HAZARD	MONITORING INSTRUMENT
Fire	Stationary ultraviolet and/or infrared flame detection

- Multi-gas monitors recommended for (as a minimum):
  - Sweet gas facilities – LEL, CO & O<sub>2</sub>
  - Sour gas facilities – H<sub>2</sub>S, LEL, CO & O<sub>2</sub>
- The alarm set points of portable gas monitors are listed in the table below.

**Table 14: Portable Gas Monitor Alarm Set Points**

ALARM SET POINT	H <sub>2</sub> S	LEL	CO	O <sub>2</sub>
Low Alarm	<b>USA:</b> 10 ppm	10% LEL	25 ppm	19.5%
High Alarm	<b>USA:</b> 20 ppm	20% LEL	100 ppm	<b>USA:</b> 23.5 ppm

- Gas test training shall cover the theoretical knowledge and a practical skills demonstration. At a minimum it will cover:
  - Explosive range and flash point
  - Threshold limit values and occupational exposure limits of substances
  - Knowledge of gas testing instruments; and,
  - Oxygen requirements.
- Gas test training is required for explosively, oxygen and hazardous chemical tests for safe work permits covering hot and cold work. This includes:
  - Practical demonstration in proper use of all gas testing equipment; and
  - Written knowledge/understanding competency test.
- Confined space entry gas testing includes the above. It is combined with confined space entry training and includes:
  - Review of legal requirements for confined space entry
  - Review of testing considerations for confined spaces; and,
  - Written knowledge/understanding competency test.

**Contractors shall ensure that Workers:**

- Understand that a Safe Work Permit is required in all locations.
- Understand that all work in hazardous locations requires gas testing and monitoring.
- Monitor the work atmosphere in a hazardous location to ensure it is maintained below the procedure specific requirements (e.g., Confined Space) and that it is not in the explosive range before and during welding, cutting, or other open flame operations.
- Refer to Confined Space section for initial Atmospheric Monitoring and ongoing testing requirements in Confined Spaces section of this manual.
- Only personnel trained to use personal/portable gas monitors will test areas for flammability and authorize work after testing is completed.

- All work in hazardous locations requires a Job Safety Analysis.
- A Hot Work Permit, as applicable, must be completed by Company.
- Spark-less and pneumatic tools are recommended for use in hazardous locations.
- Inspect extinguishers shortly before use on fire-watch. Extinguishers need not be pressurized before actual use.
- Personal monitors shall be worn by each individual when:
  - working in Confined Spaces
  - removing storage tank seals, tank manways or tank mixers
  - entering tanks that have not been cleaned and freed of gas
  - work associated with Open Systems, such as scraper traps and provers
  - spill or leak containment, clean-up, and repairs
  - required by as noted on a safe work permit
  - when required based by a Hazard Assessment
  - when performing work in a hazardous / classified location
- Personal Gas Monitors shall:
  - have multi-head functionality.
  - be worn within 45 cm (18 in) of the Breathing Zone (area around mouth and nose).
  - not be placed into shirts, coveralls, or jacket pockets unless the pockets are specially designed to hold portable gas monitors (i.e., mesh pocket)
  - provide a visual and audible alarm that is equipped with low and high alarm points
  - be recharged in a safe area, away from the area being monitored; carry out recharging as soon as possible after the low-battery indicator activates, to ensure the monitor does not shut down.
- Personal monitors shall not be used when:
  - they are past calibration date
  - they have not been bump-tested
  - there is a faulty sensor
  - working in any environment that will exceed the instrument set points.
- Personal gas monitors are not to be used for gas leak detection.
- The scope of personal gas monitoring and testing relates to workers working in the following areas of operation and/or under the following conditions, but not limited to:
  - Confined Space Entry,
  - Hydrogen Sulfide,
  - Leak Repairs,
  - Leak Surveys,
  - Oxygen Deficient Atmospheres, or
  - Hot work
- The conditions listed above are not all inclusive. The Supervisor will determine when other conditions not listed above require the use of portable gas detection equipment.
- Only trained personnel may perform calibration checks on personal/portable gas monitors.
- Prior to use the condition and working order of the device must be checked according to the manufacturer's instructions, but at a minimum must include:

- Charge /battery check
  - Verify sensors for the type of gases required to monitor
  - Check for physical damage
  - Run self-diagnostics (if available)
  - Check operation – Bump test with known gas sources is required prior to each use
  - If a condition renders the device inoperable or unreliable and it cannot be corrected during the bump test, cease use, and have the device repaired
  - Monthly (one time each month), the bump test is recorded
  - Annual calibration with NIST certified gases is required and shall be documented.
  - If a condition renders the device inoperable or unreliable and it cannot be corrected during calibration, cease use, and have the device repaired.
- An Area Monitor consists of at least one individual wearing a monitor who always remains in the affected area during the work activity. Area Monitors shall:
  - monitor the potential Hazard
  - be equipped with a visual alarm (i.e., red indicator that lights when alarm levels are reached) in addition to an audible alarm, where possible
  - be placed where the atmospheric Hazard is likely, based on the substance (e.g., placed at lower levels when monitoring for substances heavier than air)
  - be used where there is potential for exposure to atmospheric Hazards, including, but not limited to:
    - Confined Spaces
    - Open Systems
    - venting systems
    - leak sites
    - Hazardous Areas
    - Restricted Areas
    - when actively working within 30 m (100 ft.) of Ground Disturbance work which is taking place within 3 m (10 ft.) of operating Facilities (e.g., gas or oil pipelines, above or below ground); in such cases, there shall also be continuous gas monitoring, as determined by the Hazard Assessment.
- Sampling equipment (including multi-head continuous gas monitors) shall:
  - be capable of sampling according to the potential Hazard
  - be positioned within a few feet of the work area and not interfere with the task, including:
    - at the source of the gas or vapor
    - low areas (for petroleum vapors and H<sub>2</sub>S)
    - the most representative location for Workers at the site
    - areas with the highest potential for exposure
- When using grab sampling equipment such as detector tubes (e.g., Drager CMS) and photo ionization detectors (e.g., UltraRae) Workers shall:
  - obtain multiple grab samples to obtain representative exposure information

- o always follow manufacturer's guidelines for testing time limits and specifications, but combine with Atmospheric Monitoring best practices
- o stop Atmospheric Monitoring and leave the work area (following applicable safety procedures) when alarms are activated before specified length of time for measurement (i.e., one minute)

## **Hazardous Area Classification Legend**

### **Class I Locations**

Class I locations are those in which flammable gases, flammable liquid–produced vapors, or combustible liquid–produced vapors are or may be present in the air in quantities sufficient to produce explosive or ignitable mixtures.

#### **Class I, Division 1**

A Class I, Division 1 location is a location:

- (1) flammable liquid–produced vapors, or combustible liquid–produced vapors can exist under normal operating conditions, or
- (2) gases, flammable liquid–produced vapors, or combustible liquids above their flash points may exist frequently because of repair or maintenance operations or because of leakage, or
- (3) processes might release ignitable concentrations of flammable gases, flammable liquid–produced vapors, or combustible liquid–produced vapors and might also cause simultaneous failure of electrical equipment in such a way as to directly cause the electrical equipment to become a source of ignition

#### **Class I, Division 2**

Class I, Division 2 location is a location:

- (1) produced vapors, or combustible liquid–produced vapors are handled, processed, or used, but in which the liquids, vapors, or gases will normally be confined within closed containers or closed systems from which they can escape only in case of accidental rupture or breakdown of such containers or systems or in case of abnormal operation of equipment, or
- (2) flammable liquid–produced vapors, or combustible liquid–produced vapors are normally prevented by positive mechanical ventilation and which might become hazardous through failure or abnormal operation of the ventilating equipment, or
- (3) that is adjacent to a Class I, Division 1 location, and to which ignitable concentrations of flammable gases, flammable liquid–produced vapors, or combustible liquid produced vapors above their flash points might occasionally be communicated unless such communication is prevented by adequate positive-pressure ventilation from a source of clean air and effective safeguards against ventilation failure are provided.

Model: Default  
User: nasa | 06/28/23
Drawing: E:\standards\Approved\H&S\Electrical\060602.dgn  
Topic: 1/18/2018

**NOTES:**

1. ANY AREA WITHIN A 5 FOOT RADIUS OF A DEVICE WHICH VENTS GAS, UNDER NORMAL OPERATIONS, IS CLASSIFIED AS A CLASS 1, DIVISION 1 AREA.
2. ANY AREA GREATER THAN 5 FEET BUT LESS THAN 15 FEET FROM A DEVICE WHICH VENTS GAS, UNDER NORMAL OPERATIONS, OR ANY POTENTIAL LEAK SOURCE IS CLASSIFIED AS A CLASS 1, DIVISION 2 AREA.
3. THE SPACE AROUND WELDED PIPE AND EQUIPMENT WITHOUT FLANGES, VALVES, OR SCREWED FITTINGS, IS NON-CLASSIFIED.
4. DERIVED FROM AGA XL1001.

**LEGEND**

CLASS 1, DIVISION 1  
GROUP D

CLASS 1, DIVISION 2  
GROUP D

NON-CLASSIFIED

LIC.	HAZARDOUS AREA CLASSIFICATION LEGEND	DESIGN MANAGER	DRL	1-18-18	STANDARDS	
		INITIALS	DATE	DWG.	SE-0600	REV. 1

### Typical Ventilated Compressor Building

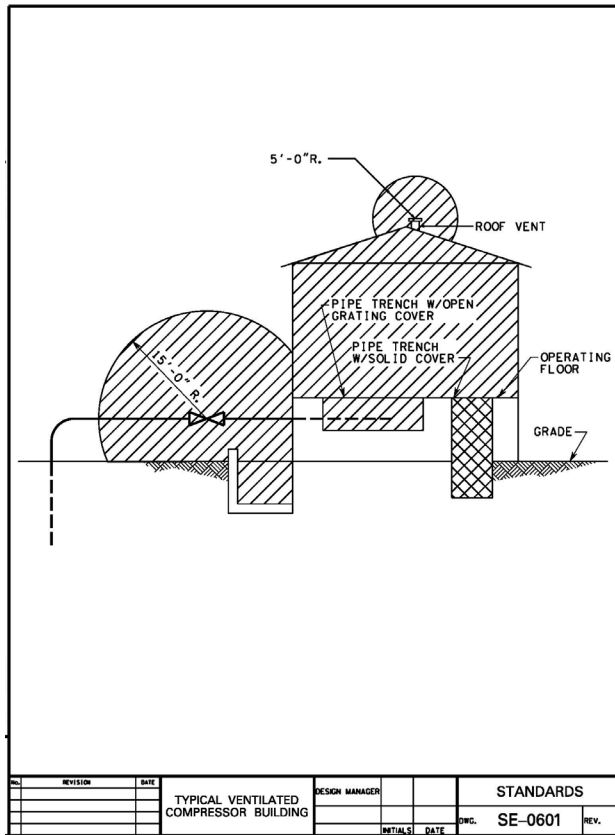

### Typical Ventilated Compressor Building with Motor Room

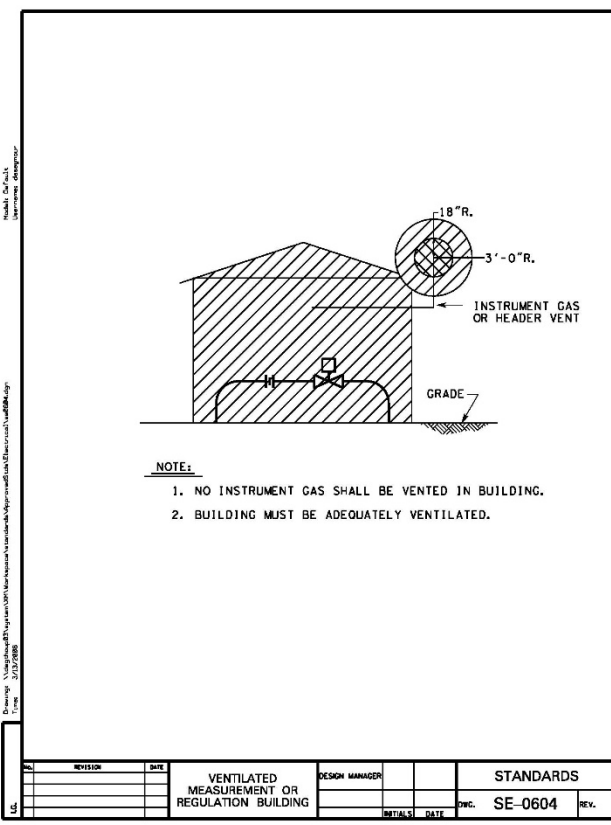
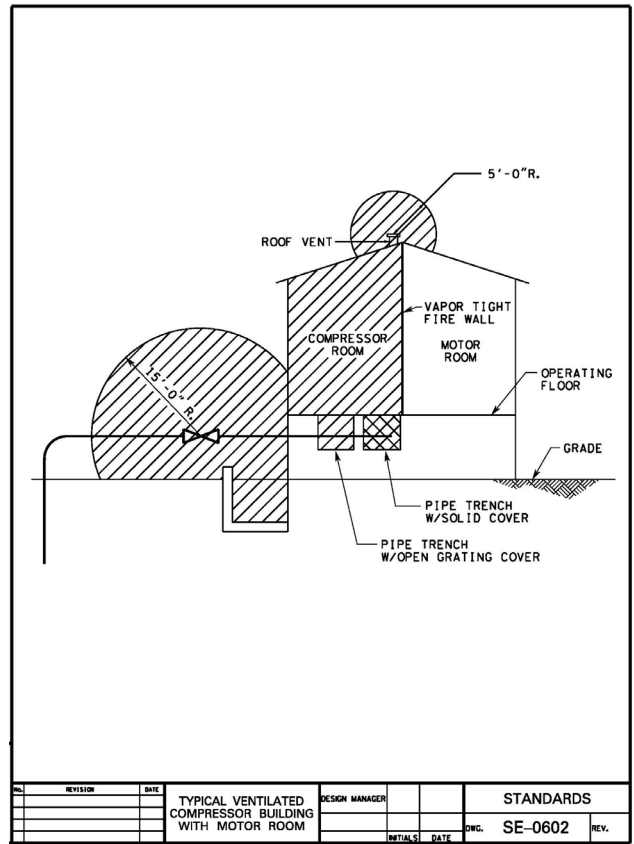

### Typical Ventilated Compressor Building with Motor Room



### Typical Ventilated Compressor Building with Motor Room

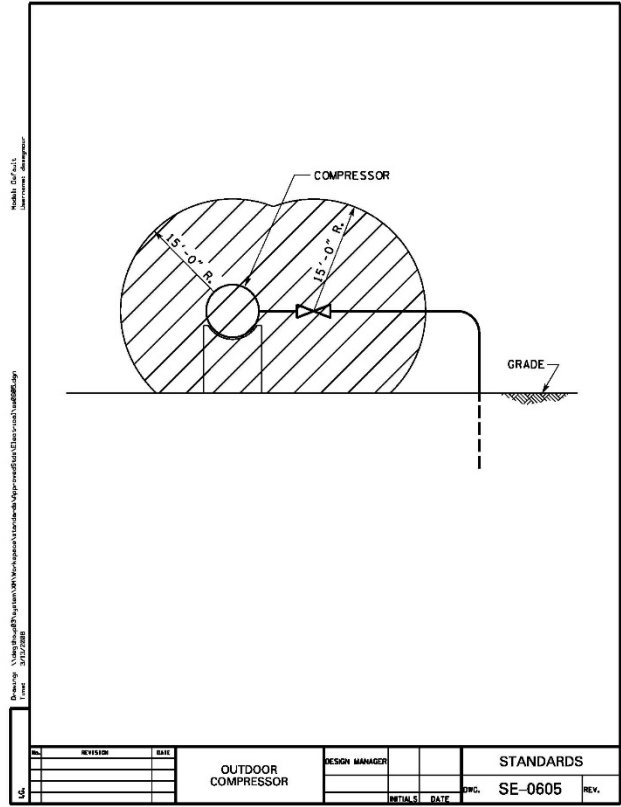

## 5.21 Hot Work

This section is applicable to all contractors/subcontractors, and visitors who may perform or be involved with welding activities and/or other hot work tasks.

- Company distinguishes between two categories of “Hot Work”, both of which are addressed below:
  - Category #1: Welding, cutting, grinding, open flame (i.e., an ignition source will be created)
  - Category #2: Use of non-intrinsically safe tools, cameras or other electronic devices or opening electrical panels in a classified hazardous area (i.e., a potential ignition source may be created)
- The “Hot Work” designation only applies when:
  - Category #1 or #2 is conducted in a classified / designated hazardous area
    - The hazardous area includes any area classified as Class 1 Division 2 or higher, or Zone 2 or higher.
    - If an area is not normally classified but may develop a flammable atmosphere due to the nature of the operations in the area, it would be treated the same as a classified hazardous area.
  - Category #1 in an area with combustible materials within 11 m (35 ft.).
  - Routine shop and fabrication work in non-classified areas fall outside the scope of “Hot Work” and hot work permitting requirements.
- Electrical work is typically Category #2 hot work. Some requirements expected for Category #1 hot work do not apply (i.e., Fire Watch or removal of combustibles) while others remain in place (i.e., continuous LEL monitoring).
  - See section 4.21 Hazardous / Restricted Areas for use of cameras or personal communication devices.

### **Contractors shall ensure that:**

- Cutting or welding is permitted only in areas that are or have been made safe for the hot work job.
- Hot work shall not be permitted in the presence of flammable or explosive atmospheres that may develop inside unclean or improperly prepared vessels, containers, tanks or equipment which have previously contained flammable or explosive materials.
- If the hot work is being done from work platforms, scaffolds, etc., the Workers must be protected against falling by using railings, a fall protection, or work restraint system.
- If the work task involves welding or cutting on an elevated work platform of 2.4 m (8 ft.) or higher above the floor, a flame-retarding tarp may be required to catch or deflect sparks.
- If the hot work will produce sparks or an open flame in a designated hazardous/classified location, two fire extinguishers shall be available for the job.
  - The Safe Work Permit should only be closed after it is determined any fire hazard has passed and the Fire Watch is free to leave.

- Oxygen and fuel-gas cylinders must be kept far enough away from welding and cutting operations so that sparks, hot slag, or flame will not reach them, or if that is not possible, fire-resistant shields shall be used.

### **Hot Work Permitting**

- Hot Work can only be performed after a Permit is issued.
- This applies to both categories of “Hot Work”
  - Category #1: Welding, cutting, grinding, open flame (i.e., an ignition source will be created)
  - Category #2: Use of non-intrinsically safe tools, cameras or other electronic devices or opening electrical panels in a classified hazardous area (i.e., a potential ignition source may be created).
  - Any time the work or tools that introduce an ignition hazard are within a designated / classified hazardous area, permitting applies
  - For Category #1, permitting also applies if the work is being done in an area with combustible materials within 11 m (35 ft.) (even if not technically or normally a classified hazardous area).
- Additional Safe Work Permit instructions as they apply to Hot Work are covered in Procedures for JSA, Safe Work Permit (SWP), and FLHA.
- A JSA must be completed for Hot Work, Category #1 activities prior to issuing the Permit.
- The applicable permit or a copy of the permit must be posted in a conspicuous location in the work area where any Hot Work, Category #1 work is taking place.
- A Permit for Hot Work is required when work is taking place in a designated hazardous/classified location and:
  - Explosion proof or sealed Class 1, Division 1 or Division 2 electrical enclosures or conduit is opened.
  - Work on electrical equipment could possibly produce a spark.
  - Non-intrinsically safe tools and extension cords are being used (e.g., general service tools like drills, extension cords, pigtailed, etc.)
  - Non-intrinsically safe electronic devices are being used.
- The Safe Work Permit Issuer may also post a Fire Watch during other hot work activities or require an additional Fire Watch if they think it is necessary for the protection of personnel, equipment, and the surrounding area (e.g., more volatile combustibles, combustibles out of sight of a single Fire Watch, etc.).

### **Atmospheric Monitoring**

- LEL monitoring is required before and always during hot work operations in a designated / classified hazardous area.
- LEL monitoring shall be performed, not only inside opened equipment, but also thoroughly monitor the area looking over, under, in between and around equipment.
- Monitor for LEL in low lying or down gradient areas near the work area.
- If monitoring results in a detectable level of LEL, then special precautions and considerations shall be identified and discussed such as additional cleaning and/or purging of equipment.

- LEL monitors need to be calibrated and operated in accordance with the manufacturer's requirements and receive a start-of-shift bump test to ensure any LEL readings prior to and during hot work are accurate. Always check oxygen levels when doing an LEL check as an oxygen deficient atmosphere may lead to an inaccurate LEL reading with certain monitors.
- Continuous LEL testing requirements for Hot Work, Category #2 may be managed by using a Personal Gas Monitor if the work does not involve opening the system or a line break (i.e., your personal alarm will go off in the event of an unanticipated gas leak or explosive vapors accumulate).
- A second Gas Monitor should be used for Hot Work, Category #1 or Category #2 where there are gas and vapor hazards to allow for spot testing, troubleshooting the source of LELs, and recording periodic readings.
- Stationary building gas detection devices (i.e., permanently installed monitors) are not acceptable for specific area detection.

### **Hot Work in Confined Spaces**

- In addition to the usual confined space requirements, the following must be applied when the task inside the confined space is Hot Work:
  - Proper cleaning and ventilation to prevent the buildup of flammable or toxic gases once heat is applied.
  - Mechanical ventilation is also required to prevent a buildup of toxic vapors or gases from the welding operation itself.
  - The gas cylinders or welding machines must be left on the outside of the space.
  - The gas supply of a torch must be positively disconnected at some point outside the confined area whenever the torch is not to be used for a substantial period such as during the lunch hour or overnight (to prevent accidental gas leaks inside the space).
  - Where practicable, the torch and hose shall also be removed from the confined space.
- For Welders in particular, if the confined space is entered via a manhole or other small opening, a quick exit / non-entry rescue method should be applied if possible. This requires:
  - The Welder to wear a full body harness
  - Lifelines and a mechanical device to pull the lifelines with the welder attached in such a way they do not get jammed in a small exit opening
  - An attendant to monitor lifelines (and other gas or electric lines running into the space) to prevent entanglement and ready to extract the Welder.
- After welding operations are complete, the Welder shall mark the hot metal or provide some other means of warning other Workers.
- Hot Work cannot start until an LEL reading of zero is confirmed (inside and outside the vessel).
- LEL must be continuously monitored during Hot Work (also both inside and outside the vessel).

### **Portable Containers**

- A Hot Work Permit is required when hot work is performed on used drums, barrels, or other containers that have contained flammable or combustible materials.
- These types of containers must be made safe to be certain there are no flammable or toxic materials present which might produce flammable or toxic vapors when heated by welding or cutting or other Hot Work. Before any heat is applied, used drums or containers must have been:
  - Vented and thoroughly cleaned or filled with water, or
  - Purged with inert gas, or
  - Made safe by other approved methods.
- Containers must also be vented to permit the escape of air or gases before and during preheating, cutting, or welding.
- Any pipelines or connections to the containers must be disconnected or blinded (blanked).
- Hot work cannot start until an LEL reading of zero is confirmed and LEL must be monitored during this type of hot work.

### **Vessels (scrubbers, Tanks, Heaters, etc.)**

- Vessels, tanks or other stationary containers must be made safe to be certain there are no flammable or toxic materials present which might produce flammable or toxic vapors when heated by welding or cutting or other hot work. Before any heat is applied, they must have been:
  - Vented and thoroughly cleaned or filled with water, or
  - Purged with inert gas, or
  - Made safe by other approved methods.
- When preparations involve the blowing down, venting and/or purging, into the immediate work area of a flammable gas or vapor the Line Breaking and Equipment Opening safe work practice will be followed.
- Isolate the vessel by disconnecting lines, blinding, or double-block-and-bleed.
- Purge, clean or ventilate to clear the vessel of all toxic and flammable vapors and gases.
- Hot work cannot start until an LEL reading of zero is confirmed (inside and outside the vessel).
- LEL must be continuously monitored during hot work (also both inside and outside the vessel).

### **Hot Tapping**

- If welding or cutting is to be conducted on piping or vessels still carrying or containing flammable substances, this falls into the category of “Hot Tapping”.
- Hot Tapping requires compliance with engineering procedures specific to piping or equipment that are supported by a specific safety procedure.

**Contractors shall ensure that Workers:**

- Wear the appropriate PPE when welding, cutting or grinding (and their helper). See section 4.35 Personal Protective Equipment.
- Post a Fire Watch for all welding and cutting operations (Category #1) when it takes place:
  - In a designated hazardous/classified location; or
  - Where there are combustible and flammable materials that cannot be removed, protected, or shielded within 11 m (35 ft.).
- The Fire Watch must be trained and competent to carry out their duties.
- The Fire Watch is required to wear the appropriate eye protection.
- The duties of the Fire Watch include:
  - Watch for fire in all exposed areas.
  - Never leave the site of the hot work without a replacement.
  - Have fire-extinguishing equipment readily available.
  - Know how to use fire-extinguishing equipment.
  - Know how to summon emergency help.
  - Only try to extinguish a fire when it is obviously within the capacity of the equipment available or otherwise sound the alarm immediately.
  - Do not perform any other tasks while on fire watch duty.
  - Immediately stop the work when conditions change.
  - A Fire Watch is required to be present during work breaks and at least 30 minutes after the completion of welding or cutting operation.
- Remove or cover combustible materials near the Hot Work.
- Inspect the general surrounding area within 11 m (35 ft.) of the hot work location to determine the presence of flammable and combustible materials and designated hazardous areas.
  - Remove all combustible materials and flammable liquids if possible, and if not, protect them with flameproof tarps or shield them with metal or flame retarding curtains.
  - Determine if wall and floor openings shall be covered or protected within 11 m (35 ft.) of the work area.
- Inspect the other side of the wall or ceiling for combustibles and flammable materials if the work task involves work on walls/ceilings.

## 5.22 Housekeeping

### **Contractors shall ensure that:**

- Garbage shall not be allowed to accumulate on a construction ROW.
- Ensure waste receptacles are emptied regularly and all garbage is collected and removed as required.
- Waste receptacles in operational areas must have lids.
- Food shall not be consumed or stored in operational areas.
- The use of industrial style dumpsters is recommended in areas where large volumes of waste can be expected.
- Waste shall be properly segregated, and flammable oil-soaked materials must be stored in a designated receptacle.
- Wildlife risks need to be assessed when determining waste receptacle and removal criteria.

### **Contractors shall ensure that Workers:**

#### **General Housekeeping**

- Keep worksites clean and orderly.
- Keep restrooms and eating areas clean and sanitized.

#### **Walkways, Pathways and Exits**

- Keep interior and exterior walkways, pathways and exits free of tripping and slipping hazards by utilizing the following:
  - Clean snow off walkways.
  - Use sand or rock salt on icy walkways.
  - Immediately clean-up oil leaks and spills from floors.
  - Consider nonskid paint in areas where the floors have the potential to stay wet or oily.
  - Place nonskid mats on painted floors inside entrance doors.
  - Keep ramps, exits, stairs, walkways, and pathways clear of tripping hazards such as hoses, ropes, cords, portable tools, spare parts, trash and debris.
  - Take the necessary precautions to prevent tripping hazards when hoses, ropes or cords are strung along or across walkways and pathways.

#### **Emergency Equipment**

- Never place any materials that block access to emergency equipment such as:
  - Fire extinguishers
  - Eye wash stations and showers
  - Emergency Shut Down (ESD) stations and valves
  - Safety warning signs
  - Electrical switches and disconnects (at least 3 ft. or 0.9 m of clearance)
  - Life rings, life preservers, life rafts, escape capsules, etc.

## 5.23 Hydrostatic and Pneumatic Testing

### **Contractors shall ensure that:**

- For worksite(s) where a section of piping is being tested, a Company representative shall be on-site.
- At the testing location there shall be:
  - A safe means of access and egress to the system being tested,
  - Adequate lighting when night work is necessary and a fire extinguisher at both ends of a test section, and
  - Adequate heating and lighting facilities as required for test workers located a minimum of 15 m (50 ft.) away from any testing facilities.
- Other requirements include:
  - Only the workers directly involved in the testing are in the immediate vicinity of test heads, pressure pumps or exposed piping during testing,
  - Preventing them from moving or violently separating, ensure temporary piping or hoses used during pressuring and depressurizing activities are anchored or secured by such method(s) as whip check connections, steel braid line wrap, or staking to the ground,
  - The use of appropriate hoses, piping, fittings, valves, etc., and that such equipment has an adequate pressure rating for the service; inspect the equipment before use, to ensure it is in good condition,
  - Persons not directly involved in the testing shall be kept back a minimum of 30 m (100 ft.) from the pipeline, using signs, fencing, and verbal warnings,
  - Verifying pressure on both sides of check valves when hydro testing and depressurizing, and
  - Providing a safe means to release pressure from both ends of the piping section; pressure shall be released prior to loosening or removal of fittings.

### **Hydrostatic Testing**

- Two zones shall be established around any hydro-test: a 15 m (50 ft.) Exclusion Zone and a 30 m (100 ft.) Zone. These requirements shall be followed during all hydro-tests. Unique circumstances may require additional measures to ensure the safety of workers and the public.
- For testing being conducted only on the ROW, expand the 15 m (50 ft.) Exclusion Zone requirements to the 30 m (100 ft.) Zone dimensions.
- If leaks are observed (through gauge drop or visual inspection) then the pressure must be reduced to zero pounds per square inch (PSI) prior to entering the Exclusion Zone. No adjustments of any kind are to be performed while the system is pressurized.
- Fuel containers, propane tanks, and other fuel storage shall not be permitted within the 15 m (50 ft.) Exclusion Zone. Testing trailers shall be parked with the entrance facing away from the test area. The testing trailer door(s) shall remain closed during testing operations. If it is necessary to test indoors, the 15 m (50 ft.) Exclusion Zone shall encompass the entire room in which the test is completed.



### **15 m (50 ft.) Exclusion Zone**

- On Company property, signs shall be placed by the Contractor on the day of the test. These signs, which are to remain in place until after the piping system has been depressurized, shall read as follows:

“DANGER – RESTRICTED ENTRY – HIGH PRESSURE TESTING AREA  
AUTHORIZED PERSONNEL ONLY”

- All unnecessary equipment and workers shall stay out of this zone when the pipe is pressurized above normal operating pressures.
- Ensure the 15 m (50 ft.) Exclusion Zone applies over the entire length of the pipeline, spools or fittings being tested. Note: Within populated areas, traffic control is required and shall be identified in the Hazard Assessment and/or Permit.
- Workers shall stay in their vehicles if they are within this zone monitoring the pipeline during the hydro- test, except for checking for leaks or opening or closing valves.
- Hydro test signs shall be placed on public access points and located at a point 15 m (50 ft.) from the pipeline.

### **30 m (100 ft.) Zone**

- Facilities for test personnel and equipment shall be outside the 30 m (100 ft.) Zone.
- This zone will not be marked; the public and other Workers shall stay at least 30 m (100 ft.) away from the pipe.
- This zone applies over the entire length of the pipeline section being tested.
- The public shall be kept out, except when crossing the pipeline in vehicles where identified in the Hazard Assessment and/or Permit.
- Landowners along the right-of-way shall be notified in advance of the hydro-test and those living within the 30 m (100 ft.) zone shall be offered relocation assistance.
- In the event additional piping or facilities (not associated with the system being hydrotested) are present in the test area or within 30 m (100 ft.), of the pressurized components, the area shall be flagged and remain off limits to all Workers during the test.
- When testing trailers or vehicles are parked implement extra precautions as necessary (e.g., stage behind large equipment).
- When testing in buildings, all points of entry are to be manned or blocked. All personnel working in the building must be appropriately notified.

### **Pneumatic Testing**

- Must adhere to Company Engineering’s specifications for pneumatic testing.
- Distinct warning signs shall be posted during air pressure testing, such as “DANGER, AIR PRESSURE TESTING IN PROGRESS.”

## 5.24 Ignition Sources

### Contractors shall ensure that:

- Prior to entering a Restricted or Hazardous Area, Vehicles and equipment shall be shut off and not permitted to enter until Atmospheric Monitoring confirms the absence of hazardous vapors.
- When in Hazardous and Restricted Areas:
  - test for oxygen levels and flammable atmospheres prior to introducing ignition sources and continuously monitor these areas while ignition sources are present
  - if a flammable atmosphere is present, use only explosion-proof electrical installations and explosion-proof electrical equipment
  - use only intrinsically safe electronic devices unless the air is initially tested and continuously monitored for flammable vapors and the equipment is listed on the safe work permit
  - shutdown vehicles and equipment when not in use or when left unattended (do not restart the vehicle or equipment until Atmospheric Monitoring confirms the absence of a flammable atmosphere)
  - use non-sparking tools that are kept clean and free from ferrous or other contaminants which may hamper non-sparking properties
  - control all potential ignition sources
  - ground and bond as required in Bonding and Grounding section
- Diesel-powered vehicles / equipment being utilized in areas where flammable / explosive vapors may be present must have controls in place to prevent the vapors from entering the engine and causing a fire or explosion.
- Positive Air Shut Offs (PASO) must be tested and working for all diesel-powered engines. If the PASO is operational, the engine will not engage. If the engine engages, the PASO is not functional. The diesel-powered engine must not be permitted to enter the hazardous or restricted area.

### Pyrophoric Iron Sulfide

- Precautions include:
  - identify equipment where iron sulfide is suspected
  - tanks and vessels shall be purged of hydrocarbon vapors before opening
  - when iron sulfide is suspected to be present, provisions shall be made to keep the inner surfaces of opened equipment wet
  - disposal of accumulated iron sulfide shall be handled quickly and carefully to avoid creating a hazard
- Use water spray to soak iron sulfide at least once every 24 hours, or more frequently if considered necessary by Operations Management. Approved products that are designed and intended to decontaminate/eliminate pyrophoric iron sulfide may also be used.
- Spray water into the vapor space at least once every 24 hours, or as often as necessary to keep this space damp. Other types of floating roof tanks do not require wetting down unless there is reason to suspect pyrophoric iron sulfide may be present.

### **Portable Catalytic Heaters**

- Portable catalytic heaters shall:
  - require continuous monitoring when used in an explosive or Hazardous Atmosphere
  - be approved for use in an explosive or Hazardous Atmosphere; approval shall be from an applicable, recognized authority, such as the American Gas Association
  - have adequate ventilation to prevent a build-up of exhaust fumes and prevent the fumes from being drawn through the heater and into the space being heated
  - have carbon monoxide monitors when required
  - have only explosion-proof electrical fittings attached
  - have a regulator between the propane bottle and the heater to reduce the pressure of gas to the heater, to a level specified by the manufacturer
  - have a thermostatic block valve installed on the propane line where it enters the heater; this serves as an automatic, positive shutoff on the line when the heater is not in use, preventing gas from escaping through the heater to the atmosphere
  - not be used in electrical enclosures where there are open relays, as the vapors leave an insulating residue on open contacts that is difficult to remove
  - be used only in accordance with manufacturer's instructions

### **Contractors shall ensure that Workers:**

- Utilize Hot Work Permits to identify and document the controls used to mitigate the hazards from ignition sources.
- Perform atmospheric testing prior to permits being issued and continuous atmospheric monitoring.

## 5.25 Isolating Line Breaks and Equipment Opening

### **Contractors shall ensure that:**

- Line breaking and equipment opening work must be subject to a hazard assessment that includes documented work steps, hazards, and required controls.
- The hazard assessment activity must include a walk down of the work area.
- This requirement may be fulfilled as follows:
  - In the US, this requires completing a JSA.
    - For regularly performed jobs, reviewing a standing JSA for the job is acceptable.
    - For Offshore, a Safe Work Permit is also required.
- If the scope or conditions of the work changes (after the hazard assessment and/or permitting), the job must be shut down and the hazard assessment and permit (as applicable) review and potentially rewritten/reissued.
- Planned isolation and LOTO that were required prior to line breaking or equipment opening have been executed as planned.
- Work areas that may experience a hazardous atmosphere are free and clear of any other personnel prior to any gas or vapor release.
- In the event scope or conditions change, ensure hazard assessment, or permit documents are rewritten or re-issued as required to meet the new scope and conditions prior to work beginning again.
- Ongoing atmosphere monitoring and recording as required when working around open pipe or equipment with a potential to release gases or vapors.
- Clear communication to all workers involved and any other workers in the area under what conditions evacuation of the area must occur.
- Portable gas monitors (e.g., unit with pump and hose to find leaks or portable area monitor) may be required based on the nature of the job.
- The work should be planned and conducted to minimize the volume of flammable or toxic gas, vapor, or liquid released and the period in which there is potential for any release.
- Once isolation is established (any further gas, vapor, or liquid release is fully contained) and the area atmosphere is proven safe, respiratory protection may be removed but continuous area atmosphere monitoring should continue (see above) with periodic recording as set out in the Safe Work Permit (as applicable).

### **Isolation**

- Isolation, de-energizing, proving de-energized state, and applying Lock Out / Tag Out needs to be planned and documented at some stage in the work planning or hazard assessment process.
- The potential hazards presented by gases, vapors, or liquids in lines and applicable controls need to be considered in this process (e.g., Is the fluid hot, toxic, flammable or flashes off flammable vapors, under pressure? Or more than one of these?).
- Isolation and LOTO must be completed using the appropriate forms.

- When planning mechanical isolation (for both upstream and downstream of the equipment), consideration should be given to the “Levels of Isolation Methods” (shown in the table below), to achieve a level of isolation and assurance of de-energized state that provides sufficient protection given the nature of the fluid being isolated (within the limits of the equipment configuration).

**Table 13: Levels of Isolation Methods**

ISOLATION LEVEL	MECHANICAL ISOLATION	ENERGIZED STATE
Highest Level 	Air Gap	Positive Isolation
	Double Block Bleed and Blind	
	Single Block Bleed and Blind	
Lowest Level	Double Block and Bleed	Proved Isolation
	Single Block and Bleed	

**Levels of Isolation Methods**

- Blowing down, venting, or purging are effective controls as part of line breaking and equipment opening and must be considered prior to opening equipment. The risks they create, however, also require planning and additional controls which should be documented on the JSA, Procedure, Safe Work Permit, or other planning documents reviewed just before the job starts. For example:
  - Venting of any gas should always be done with consideration to where the vented gas will linger or migrate to—facility vents and flare systems are preferable to venting near or into a work area if possible.
- The following procedure steps are provided to assist in developing JSAs or procedures for line break or equipment opening activities to prevent a flash fire and/or exposure to toxic gases (especially H<sub>2</sub>S). Where a region or equipment specific opening procedure does not exist, these are the minimum requirements for safe operations.

**Equipment Opening Procedure**

1. Assess the weather conditions, such as wind direction.
2. Assess the characteristics of the gas or vapor to be released.
3. Determine if there is fluid in the equipment that could continue to vapor off.
4. Don applicable PPE (e.g., SCBA/SABA if required for potential H<sub>2</sub>S above 5 ppm in breathing zone) and apply any other applicable planned controls prior to breaking the equipment seal.
5. Check all sources to ensure pressure is blown down before breaking the equipment seal.
6. Consider leaving several bolts and/or nuts in place, but snug, when breaking the seal just in case there is still pressure present.
7. Position out of the line of fire; use proper body positioning to limit potential exposure.
8. If gas or vapor is expected to be released or is being released:
9. Leave the immediate area once the equipment seal is broke.
10. Restrict entry to the release area; give the area time to clear of gas or vapor.
11. Approach the release area from upwind with a LEL/ H<sub>2</sub>S monitor.
12. Verify a safe atmosphere by thoroughly monitoring the area moving over, under, in between, and around the equipment at different levels.

13. Evacuate personnel from the work area if the monitor alarms.
14. Once a safe atmosphere has been verified, complete the opening of the equipment.
15. Continuously monitor the immediate work area for LEL/ H<sub>2</sub>S while the equipment is open, evacuating personnel if necessary.
  - Workers shall utilize the required PPE. See section 4.35, Personal Protective Equipment.
  - The work must be conducted with continuous monitoring for flammable (LEL) and toxic atmospheres (especially H<sub>2</sub>S) and oxygen deprived atmospheres.
  - At minimum, personal gas monitors must be worn by all participants in the work.
    - In the event personal gas monitors are removed by workers under supplied air to prevent damage to H<sub>2</sub>S sensor heads, another means to continuously monitoring for flammable atmospheres (LEL) must be used.

#### **Contractors shall ensure that Workers:**

- Participate in hazard assessment activities prior to work (e.g., JSA creation/review, discuss Safe Work Permit, FLHA, etc., as set out below).
- Apply all controls set out in the work plan / hazard assessment documentation, including PPE requirements (e.g., FR outer layer and SCBA/SABA if >5ppm H<sub>2</sub>S in breathing zone).
- Wear and use gas monitors as required below (and as per JSA/Safe Work Permit) and exit the work area when atmosphere readings warrant or alarms sound (as communicated by PIC).

#### **Safety Watch**

- Is required for line breaking or equipment opening where there is a possibility of an atmosphere with more than 5 ppm of H<sub>2</sub>S in the Workers' breathing zone.
- Must participate in pre-job hazard assessment or tailgate meeting.
- Must be out of range of possible hazardous atmosphere but in constant line of site of workers.
- Must have SCBA/SABA donned but mask may remain off.

## 5.26 Journey Management

### **Contractors shall ensure that:**

- Where a Hazard Assessment determines the need for a journey management plan, the plan shall include:
  - Contact information and travel schedule (identifying the route, timeline of travel and stops to be made)
  - Emergency contacts and emergency response guidelines
  - Communication frequency
  - Weather and travel considerations
  - Changes to travel plans
  - If the Workers journey is hindered by weather or other emergencies, the individual's top priority should be to move to a safe location, contact emergency personnel, if necessary, then contact his or her supervisor as soon as reasonably possible
  - In cases where a Worker travels for extended periods of time as part of their regular job duties (extending the total work day beyond 12 hours), a travel management plan should be developed as part of the Contractor plan

## 5.27 Ladder Safety

### **Contractors shall ensure that:**

Portable wooden ladders meet requirements from *OSHA 1910.23* Ladders.

### **Portable Ladders**

- Only CSA or ANSI approved ladders of commercial grade with visible/legible load ratings shall be used.
- All ladders must be maintained in a safe condition with special attention given to the following:
  - Joints between steps and side rails are tight.
  - Hardware and fittings must be securely attached.
  - Moveable parts must be free and operable.
  - Moveable bearings must be lubricated.
  - Frayed or worn rope replaced.
  - Safety feet must be operable.
  - Rungs and steps must be kept clean and free of defects.
  - Safety feet and other auxiliary equipment shall be kept in good condition to insure proper performance.
- Portable ladders shall be properly stored when not in use.
- Short ladders shall not be spliced together to make long ladders.
- Do not use portable ladders to form a walkway between two platforms or surfaces.
- Ladders shall never be used in the horizontal position as scaffolds or work platforms.
- Single ladders longer than 9.1 m (30 ft.) shall not be used.
- Portable Metal ladders shall be labeled, “Non-electrical Work” and shall not be used in or around electrical equipment.
- Portable ladders need to be insulated or have non-conductive side rails or beams where there is a risk of electrical hazard.
- Portable stepladders longer than 6 m (20 ft.) shall not be used.
- Stepladders shall be equipped with a metal spreader or locking device of sufficient size and strength to securely hold the front and back sections in an open position.
- Extension ladders longer than 18.3 m (60 ft.) shall not be used.
- On two-section extension ladders, the minimum overlap for the two sections in use is listed in the table below.

**Table 14: Minimum Section Overlap on Two-section Extension Ladders**

SIZE OF LADDER	OVERLAP M (FT)
Up to and including 10.9 m (36 ft.)	0.9 m (3 ft.)
Over 10.6 m (36 ft.) up to and including 14.6 m (48 ft.)	1.2 m (4 ft.)
Over 48 up to and including 18.2 m (60 ft.)	1.5 m (5 ft.)

- All wood parts of a ladder shall be free from sharp edges and splinters.
- Low density wood shall not be used in the site construction of ladders.
- Wood ladders are not permitted in hazardous / classified locations.
- If ladders tip over:



- Inspect ladder for side rails dents or bends, or excessively dented rungs.
- Check all rung-to-side-rail connections.
- Check hardware connections.
- Check rivets for shear.

### **Contractors shall ensure that Workers:**

- Inspected ladders before use and if found defective shall be withdrawn from service for repair or destruction and tagged or marked as “Dangerous, Do Not Use.”
- Inspect ladders for the following items:
  - Loose or missing rungs or cleats.
  - Loose nails, bolts, or screws.
  - Cracked, broken, split, dented, or badly worn rungs, cleats, or side rails.
  - Splinters.
  - Corrosion of metal ladders or metal parts.

### **Ladder Use Guidelines**

- Do not load ladders beyond their maximum intended loading limits.
- Ladders shall be placed with a secure and level footing, tied off, or held in position.
- Secure a straight ladder or extension ladder by tying the top portion to a fixed support.
- Secure locking ladder hooks before ascending or descending an extension ladder.
- Secure portable ladders at the base where a kick-out hazard exists.
- Step ladders are to be fully opened, spreaders locked and placed with level footing.
- Keep ladders clean and free of dirt, paint, oil, grease or slippery materials. Wipe shoes of oil, grease, or mud before climbing a ladder to avoid slipping.
- Keep the trunk of the body between the rails of the ladder.
- The area around the top and bottom of ladders must be kept clear.
- Never move, walk, shift or extend a ladder when it is occupied.
- Never use a step ladder as a straight ladder.
- Never use the top step or the top of the ladder as a step.
- Never use the back section cross bracing for steps on a step ladder.
- Never run hoses, extension cords, or ropes on a ladder.
- Face the ladder, use both hands while climbing and use three-point contact when ascending and descending.
- Keep your body near the middle of the rungs (body centerline stays between the side rails or beams).
- Climb ladders by grasping the rungs and not the side rails or beams.
- Keep both feet on the ladder rungs when stationary.
- Only one person is allowed on a ladder at one time and workers shall not walk underneath a ladder being ascended or descended.
- Do not use portable ladders in strong winds.
- The proper angle for setting up a ladder is to place its base a quarter of the working length of the ladder from the wall or other vertical surface (4:1 ratio).
- Ladders used to gain access to a roof, another work surface or other area shall extend at least 0.9 m (3 ft.) (Generally three rungs) above the point of support or level accessed.

- Ladders shall not be placed in front of doors openings, unless the door is blocked upon, locked, or guarded.
  - Barricade the area around ladders or position a Worker in front of the ladder if it is placed in an aisle or other location where a person or an object could strike it.
- Ladders shall not be placed on boxes, barrels, or other bases to obtain additional height.
- The top of portable ladders must be placed so that the side-rails or beams are supported.
- Do not stand on rungs above a landing against-which a portable ladder is placed.
- Where practical, step ladders over 3 m (10 ft.) in length should have the top tied off. If not possible, someone must hold the base of the ladder.
- When working on a portable ladder above 1.8 m (6 ft.) the ladder must be held by a person when it is not secured.
- Use fall protection at heights above 1.8 m (6 ft.), unless:
  - the ladder is situated directly in front of the work and the worker does not need to lean to conduct the task (e.g., moving their body's centerline 'outside' of the side-rails or beams), or
  - you can maintain three-point contact, or
  - the work is considered light duty and short duration work.
- Place small tools in a tool bag and hoist with a rope to keep hands free for ascending and descending.
- Carry portable ladders below shoulder level.
- Ladders carried on vehicles shall be secured to prevent damage and falling off vehicle.

## 5.28 Lockout Tagout

Contractors shall meet requirements established in *OSHA 29CFR 1910.147*.

### **Contractors shall ensure that:**

- Incorporate the Contractor's Lockout / Tagout program into the Company program.
- All Workers involved in the Lockout Tagout job sign the permit.
- Lockout Tagout permit is completed prior to the start of the job.
- Contractors will apply their own locks on equipment or a group lock box (depending on type of lockout) where they are an Authorized Worker.
- All Affected Personnel shall be notified when a Lockout / Tagout is applied and removed from their work area.

### **Contractors shall ensure that Workers:**

- Follow the direction of the Authorized Worker as it affects the operation of the equipment being locked and tagged.
- Remove personal lock(s) when task is complete or prior to leaving site (whichever comes first).
- Follow the direction of the PIC as it relates to the LOTO activities.
- Stop and/or correct work if LOTO procedures are not being followed.

## 5.29 Machinery and Equipment Guarding

### **Contractors shall ensure that:**

- Equipment has proper machine guarding.
- Guards shall be constructed from expanded metal, perforated or solid sheet metal, wire mesh on a frame or angle iron on sheet or iron pipe securely fastened to the floor or to the frame of the machine.
- Guards shall be constructed of a strength to support the weight of a Worker if in a place that requires the Worker to step on the guard or push against it.
- Toe boards shall be used where guardrails are provided around openings on equipment that is exposed to falling hazards.
- One or more methods of guarding (examples: barrier guards, two-hand tripping devices, electronic safety devices, etc.) shall be provided to protect the Operator and other Workers in the machine area from hazards such as those created by point of operation, in-going nip points, rotating parts, flying chips and sparks.
- Guards shall be affixed to the machine where possible and secured elsewhere if, for any reason, attachment to the machine is not possible.
- The guard shall be such that it does not become an accident hazard itself.
- Guarding devices shall be designed and constructed to prevent the Operator from having any part of his or her body in the danger zone during the operating cycle.
- Removal, alteration or defeating of guards on machinery or equipment is prohibited except for inspection, repair, or replacement purposes.
- Machinery or power tools that are not equipped with proper guards should not be operated. Guards and protection shall:
  - meet manufacturer's specifications and Applicable Legislation
  - be in good working order and inspected regularly
  - not be modified or removed
  - be replaced if damaged
  - be the correct size
  - be secure, and tamper-proof
  - prevent falling objects
  - allow for safe maintenance and inspection
  - create no new Hazards or interference
  - Provide a method to protect Workers from Hazards created by point of operation, ingoing nip points and rotating parts.
- When the periphery of the fan blades is less than 2.13 m (7 ft.) above the floor or working level, the blades shall be guarded. The guard shall have openings no larger than 1.25 cm (½ in).
- Machines designed for a fixed location shall be securely anchored to prevent moving. Examples are drill presses, pedestal grinders, lathes, milling machines, etc.

**Woodworking Machinery Requirements:**

- Each machine shall be constructed to be free from sensible vibration when the largest size tool is mounted and runs idle at full speed.
- All belts, pulleys, gears, shafts and moving parts shall be guarded in accordance with specific requirements, which are detailed in a later portion of this section entitled Mechanical Power Transmission Apparatus.
- Each hand-fed planer and jointer with a horizontal head shall be equipped with a cylindrical cutting head, the knife projection of which shall not exceed 0.3 cm (1/8 in) beyond the cylindrical body of the head.
- Each hand-fed jointer shall have an automatic guard that will cover the sections of the head on the working side of the fence or gauge.
- Each saw shall be provided with a guard that will protect the Operator from flying splinters, broken saw teeth, and sawdust.
- Each saw shall be provided with non-kickback fingers or dogs and spreaders.
- All portions of the band saw blade shall be enclosed or guarded except for the working portion of the blade.
- All saws, knives and cutting heads shall be kept sharp.
- Push sticks or push blocks shall be provided at the work place.
- Frames and all exposed non-current carrying metal parts of portable electric wood-working machinery operating at more than 90 volts to the ground shall be grounded.
- Electric power-operated hand tools shall be of the approved double insulated type or grounded using a separate ground wire and polarized plug whenever there is more than 90 volts to the ground.

**Machine Control and Equipment:**

- A mechanical or electrical power control shall be provided on each machine to make it possible for the Operator to cut off the power without leaving his/her position at the point of operation.
- On each machine operated by electric motor, positive means shall be provided for rendering such controls or devices inoperative while repairs or adjustments are being made to the machines they control.
- Permanently wired woodworking machinery shall be equipped with a disconnect switch that can be locked in the off position.

**Mechanical Power Transmission Apparatus:**

- Power transmission equipment shall be regularly inspected and shall be kept in good working condition.
- Rotating shafts shall be kept in alignment.
- Hangers shall be inspected to make sure supporting bolts and screws are tight.
- Pulleys shall be inspected for loose bolts or nuts.
- Belts and fasteners shall be inspected and kept in good repair.
- Lubrication shall be performed per manufacturer's recommendations.
- Flywheels shall be enclosed with sheet, perforated or expanded metal, or mesh wire on a metal frame.

- Flywheels protruding through a floor shall have a guardrail placed not less than 38 cm (15 in) or more than 51 cm (20 in) from the rim. Standard toe boards shall be provided.
- Guard exposed pulleys, belts and friction drives, gears, sprockets, and chain drives.
  - Hand operated gears such as hand operated winches do not require guards.
- Keys, set screws and other projections in revolving parts, must be removed, made flush, or guarded with metal covers.
- Revolving collars shall be cylindrical.
- Screws or bolts used in collars and couplings shall not extend beyond the largest diameter of the collar or beyond the flange of the coupling unless covered with a metal sleeve.
- Exposed parts 2.13 m (7 ft.) or less from the floor or working platform, except runways used exclusively for oiling or running adjustments, shall be protected by a stationary casing that encloses shafting completely or by a trough that encloses sides and top or sides and bottom of shafting as location requires.

### **Contractors shall ensure that Workers:**

#### **Grinding and Buffing Wheels:**

- Perform ring test on grinding and buffing wheels.
- Adjust the tool rest, if necessary, so it is within 0.3 cm (1/8-in) of the wheel; make no adjustment while the wheel is in motion. Also, adjust the tongue guard so it is within 0.6 cm (1/4-in) of the wheel.
- The safety shield must always be kept in place and be clean.
- Hand protection shall be used when grinding stock that could cause injury to hands.
- Respiratory protection should be worn when grinding items that produce dust or fumes.
- Ensure the face of the wheel is properly dressed and the guard is in place.
- When it is necessary to change a wheel, inspect the new wheel for cracks or other imperfections to make sure it has not been damaged.
- Unplug power to the grinder and place power cord in view before replacing the used grinding wheel.
- A safety washer must always be installed between the grinding wheel and the securing flange. The protective shield shall always be replaced after changing the wheel.
- After a new grinding wheel has been installed, stand to the side and conduct a test run of one minute.
- Always wear safety glasses with side shields or goggles and a face shield when operating a grinder or buffer.
- Hold the work in such a manner that hands will not be injured in case of slippage.
- Apply the work gradually so abrupt contact with the grinding wheel can be avoided.
- Do not operate the wheel at a speed more than its design speed.
- Do not use the side of a wheel for grinding unless it was designed for that purpose.
- Make sure the composition or type of grinding wheel is compatible with the material being worked on.
- Defective grinders should be reported to the Supervisor, and an appropriate “Do Not Operate” tag should be installed until the defect is corrected.

## 5.30 Manual Handling of Materials and Back Safety

### **Contractors shall ensure that:**

- Storage of materials shall not create a hazard.
- Bags, containers, bundles, etc., stored in tiers shall be stacked, blocked, interlocked, and limited in height so that they are stable and secure against sliding or collapsing.
- Where mechanical handling equipment is used, sufficient safe clearances shall be allowed for aisles at loading docks, through doorways and wherever turns or passage must be made.
- Aisles and passageways shall be kept clear and in good repair with no obstruction across or in aisles that could create a hazard.
- Permanent aisles and passageways shall be appropriately marked.
- Bagged materials stored in tiers are to be stepped back and cross-keyed at least every 10 bags high.
- Non-compatible materials are to be segregated in storage.
- Storage areas shall be kept free from accumulation of materials that constitute hazards from tripping, fire, explosion, or pest harborage.
- Vegetation control will be exercised when necessary.
- Proper drainage of work and storage area shall be provided.
- Clearance limits and warning signs shall be provided.
- Covers and/or guardrails shall be provided to protect personnel from open pits, tanks, vats, ditches, etc.
- Maximum safe load limits of floors (except floors or slab on grade) shall be conspicuously posted and not exceeded.
- Standard guardrails including top rail, mid rail and a toe guard should be installed to prevent stored materials from falling when applicable.
- Ramps, blocking or grading should be used to ensure safe movement of vehicles between different levels.
- Used lumber shall have all nails withdrawn and stacked to prevent falling.
- Piles of lumber that are worked manually are not to exceed 5 m (16 ft.) in height.
- Structural steel, poles, pipe, bar stock and other cylindrical materials, unless racked, shall be stacked, and blocked to prevent spreading or tilting.

### **Contractors shall ensure that Workers:**

- Workers involved in materials handling will use the appropriate PPE. Gloves or other hand protectors, aprons, eye/face protection should be worn to prevent hand, body, and face injuries especially when handling material with sharp edges, wooden material or corrosives.
- If a load is too heavy for one worker to lift, get help or use mechanical lifting equipment.
- Are discouraged to manually lift or carry loads weighing in excess of 99 lbs. (45 kg) or weights they are not comfortable lifting by themselves. Where possible utilize a dolly, cart, pallet jack or similar. Where feasible, lifting aids (lift tables, mechanical or powered assists, hoists, etc.) should be used to move heavy or bulky loads.
- Where a worker is required to manually lift or carry loads in excess of 99 lbs. (45 kg), a field level hazard assessment must be completed prior to task commencement.

## 5.31 Marine and Offshore Operations Safety

### **Contractors shall ensure that:**

- Workers who are involved in offshore marine operations receive the required Marine Survival training.
- Workers may be required to attend training classes on specific customer platform or rig safety requirements prior to being transported to the customer's location.
- All workers who are reasonably expected to use a swing rope shall pass a swing rope test prior to being allowed to do so, and every four (4) years thereafter.
- All necessary equipment is provided for Workers required to work in the offshore marine operations.
- PFDs (life preservers, life jackets, or work vests) worn by each Affected Worker must be United States Coast Guard (USCG) approved pursuant to 46 CFR part 160 (Type I, II, III, or V PFD) and marked for use as a work vest, for commercial use, or for use on vessels.
- Personal flotation devices shall be maintained in safe condition and shall be considered unserviceable when damaged in a manner that affects buoyancy or fastening capability.
- Annual inspection of Contractor owned Swing Rope shall be documented.

### **Contractors shall ensure that Workers:**

- Participate in offshore marine work activities only after receiving the proper required training.
- Follow offshore marine procedures for wearing the proper PPE, boarding crew boats and platforms and working on the platforms.
- Follow all instructions of the Captain of any vessel used for transporting to off shore facilities.
- Proper slip resistant safety shoes are always required.
- All Workers assigned to marine operations will wear a PFD (Personal Flotation Device) when being transferred between vessels, on outside decks of LNGs and on any platform dock or barge that has unguarded sides next to the water.
- Participate in all emergency drills at the discretion of any ship's Captain or platform manager.
- Vessels, docks, barges and platforms are classified areas and restrict the use of open flames, flashlights, cameras, cell phones or any spark producing items. Smoking may be permitted in designated areas only.
- Check clothing requirements including inclement weather gear.
- Ensure electrical equipment will work on the electrical services provided on the ship or platform.
- Traveling to a vessel, upon arrival, inform the Captain they are taking a medication.
- Recommended Rope Specifications:
  - 3-Strand 1.9 cm (¾ in) Poly Dacron or Nylon rope with 5 knots standard, spaced 0.6 m (2 ft.) apart. Wrapped with 1.3 cm (½ in) synthetic rope between knots and dipped in polyurethane. Follow manufacturer's Rope Usage and Care guidelines.
  - Minimum load strength/capacity of the rope shall be 3 times the largest person or cargo to be transferred.
  - Rope Inspections. The rope shall be visually inspected by everyone prior to use.
- Visually inspect the rope for:
  - Pull or tug on the rope to test the connections for strength.



- Observe the rope for visible cuts, fraying, or unravelling.
  - Observe any metal connections or hardware for rust.
  - Observe any oil, mud, paint or chemical coatings that may be on the rope.
  - Check for degradation (brittleness) such as from UV damage (sun) or chemical exposure.
  - Check for pad eye and other associated linkage for cracks, physical damage from impacts, and attachments.
- Test the strength of the rope by applying body weight over secured area before initiating the swing transfer.

### **Conducting a Transfer**

- Personnel Basket transfers over water are hazardous; therefore, these transfers are to be used only when the Captain of the vessel has approved them. The following procedures shall be followed when using this form of personnel transfer:
  - Do not exceed the rated capacity of the transfer basket.
  - Wear a PFD.
  - Secure hard hat and glasses.
  - Hold on to the basket ropes or rigging with both hands facing inward.
  - Store all small loose items in the center of the basket. Large items are to be transferred by a cargo net.
  - Step off the basket only when it has completely landed.
- A JSA shall be completed and reviewed with all personnel prior to commencing swing rope transfer activities. Only one JSA is required to be completed and reviewed per swing rope transfer event. If anyone deems the transfer to be unsafe, the Captain is expected to abandon the transfer. Workers are also authorized to use their Stop Work Authority (SWA) if they perceive conditions that are unsafe, or they object to the activity based upon a lack of understanding of these procedures. There will be no repercussion to the person(s) who stops the transfer exercising their SWA.
- All personnel will conduct a risk assessment and evaluate the hazards to determine if it is safe to proceed with the personnel transfer during adverse weather conditions such as high/choppy seas, high winds or water temperatures below 12.7°C (55°F).
  - Input from the Captain of the vessel should be requested as part of the risk assessment.
- Transfers shall be conducted with another person to observe/assist the transfer. They will be responsible for:
  - Assuring that the boat is in the proper position before swinging. The Captain/crew must maintain the engine to keep the boat an acceptable distance from the platform during the transfer.
- A deck hand must also be present to assist the person being transferred.
  - Issues the “Man Overboard” and keeps a visual location of any person who falls into the water.

- Rescue operations. If someone falls into the water during a transfer, rescue operations will immediately commence.
  - A life ring shall be available for rescue operations as required.
  - Accompanying personnel shall sound out the “Man Overboard” call.
  - Designated person shall continue a visual location of the downed person.

## 5.32 Material Handling and Storage

### **Contractors shall ensure that:**

- During the storage and handling of materials, all materials are safety and properly stored on Company property, by utilizing proper storage techniques, distances, and conditions of order are maintained,
- Advanced planning for material handling and layout shall include the size, shape, type and weight of the various materials.
- The storage of materials shall be segregated as to kind, size, length and then placed in neat, orderly stacks that are secured from collapse or movement.
- All materials, goods or things shall be stored and placed in such a manner that Workers are not required manually to lift materials, goods or things in a manner that would lead to overextension of or excessive strain on the body.
- Products delivered in tanks, drums or cylinders shall be stored in a safe manner protecting the identification labels and following any special storage requires for the individual products.
- For storage and dispensing of flammable liquids, see Section 4.17 Flammable & Combustible Materials.
- All containers used for dispensing flammables shall be grounded and bonding shall be used when transferring flammables from one container to another.
- For Compressed Gas Cylinder storage, see Section 4.8 Compressed Gas Cylinders.
- Access to walkways, aisles, and emergency equipment should be kept clear of stored material.
- When unusual material handling operations are planned, special safety considerations should be developed and reviewed by the crew assigned the job.
- The proper equipment is utilized to handle the storage of bulk materials.
- Only trained and if required licensed Workers will operate the material handling equipment.
  - All equipment operators shall be properly trained and certified/ licensed for the various types of handling equipment.
- All shelves will display their load rating or have ready the manufacturers load rating guide for the shelving.
- If the stacks of material are deemed high, they shall be stepped back as the height increases.
- For Hand Trucks, see Section 4.20 Hand and Portable Power Tools.

### **Pipe Storage**

- Pipe shall be stored on specially designed dirt and sand sills or racks.
- Load ratings must be visible on pipe storage racks.
- All pipes containing asbestos pipe wrap material must be stored on plastic sheeting in order to protect the environment.

- All pipes shall be safely blocked, if the dirt sill or storage rack cannot prevent the individual pipes or pipe stack from moving.

### **Manual Drum Handling**

- Determine the weight of the contents.
- Use a drum lifter to lift or lower a drum from an upright position and use team lifting when a drum lift is not available.
- Use a drum dolly to move an individual filled drum.
- To roll an empty drum, grasp the chime with both hands.
- Lean the drum slightly inward and roll slowly on bottom chime, rotating hands as the drum rolls.
- Return the drum to an upright position to change direction and with the drum facing in the new direction, reposition hands and begin roll procedure.

## 5.33 Mechanical Heavy Equipment Safety

### Contractors shall ensure that:

- The selection of heavy equipment shall be made according to the scope of work being completed.
- All mobile equipment used on Company sites shall be constructed and maintained to manufacturer specifications. Ensure all Contractors owned, leased, operated heavy equipment is inspected before use and maintained in a safe condition.
- At a minimum, all heavy equipment shall be equipped with:
  - An audible back-up alarm and a manually operated horn
    - The horn must be distinguishable from the surrounding noise level
    - Operate the horn as needed when the vehicle is moving in either direction
    - Keep the horn in operative condition
  - Adequate front and rear light
  - Adequate braking system for tasks being performed
  - A screen, shield, grill, deflector, guard, or other adequate protection for the Operator where the Operator may be exposed to the hazard of a flying or intruding object.
- Equipment shall have seat belts for the Operator when seated in the normal seating arrangement.
- Heavy equipment shall be provided with ROPS.
- Operators shall be qualified based on experience and training received to operate the equipment they are using. Only trained and qualified Workers may operate mechanized heavy equipment. Heavy equipment operators are trained in the safe operation of their equipment based on type and manufacturer.
- An exclusion zone shall be established around all mechanized equipment. This includes control of swing zones and any area over which a suspended load could travel.
- No person shall enter the exclusion zone without permission from the Operator and/or Spotter.
- The Operator shall never exceed what the heavy equipment is capable of performing according to manufacturer limitations and safety factors. Do not exceed the maximum lifting capacity of the equipment that is displayed on the mechanized equipment.
- Operators must complete daily inspections of equipment and be prepared to present this upon inspection.
- Operators shall complete pre-job hazard analysis (JSA) prior to any work. This shall include, but is not limited to review of excavation hazards, material handling, access and egress to the equipment, electrical hazards, proper rigging of loads, and load limitations.
- Do not start the equipment or operate the controls from any position other than the driver's seat. No one except the Operator may ride in or on the mechanized heavy equipment.
- Operators shall ensure that equipment is properly disengaged and configured when leaving the equipment – even for short periods of time.
- Before leaving the Operator's seat, lower the boom to a safe position with the bucket on the ground, and turn off the equipment.
- Maintain general site housekeeping to facilitate safe equipment operation.

- Spotter shall be used whenever appropriate to ensure that inadvertent contact is not made with any person or other piece of equipment.
- Do not operate earthmoving or compacting equipment with an obstructed rear view in reverse unless: The equipment has a reverse signal alarm distinguishable from the surrounding noise level; or a Spotter signals that it is safe to do so.
- Verify the location of underground utility lines by using the “One Call System” before starting any excavation or underground boring activities.
- Workers take into consideration marked and unmarked terrain hazards which could inhibit the safe operation of mechanized equipment.
- After completing excavation or trenching activities, ensure that spoil piles are correctly placed, stable, and that booms, buckets, loaders, blades, etc. are in the correct stable position.
- Shut down the engine when filling the fuel tank. When filling the fuel tank on the mowers, rest the fuel can on the tank or metal funnel to eliminate static electricity.
- When mobile lifting equipment or excavation equipment is used near energized overhead power lines or stationary electrical equipment at least 3 of 5 layers of safety controls will be used.

### **Excavators / Track Hoes**

- Support and protect any exposed underground installations while the excavation is open or remove them as necessary to protect personnel.
- When mechanized equipment must operate near an excavation and the Operator does not have a clear, direct view of the edge of the excavation, place barricades or stop logs around the perimeter of the excavation or use a Spotter and hand signals to assist the Operator.
- To avoid cave-ins:
  - Position excavator at a safe distance from the edge of an excavation or trench.
  - Take special precautions if an excavation or trench is accumulating water.
  - Place removed material far enough from the excavation or trench to prevent overstressing the trench walls and to maintain a clear work path – refer to *Table 11: Minimum Distance for Materials from Edge of Excavation*.

### **Bulldozers**

- Bulldozers with a winch will be equipped with a protective guard over and at the rear of the Operator. The guard must be constructed of at least 0.3 cm (1/8-in) steel plate or at least 0.6 cm (1/4-in) woven wire mesh with openings no larger than 2.5 cm (1 in).
- Block or completely lower the bulldozer blade when the bulldozer is not in use.
- Substantial cribbing is in place before working on or under a raised blade. The height of the cribbing must not exceed the width of its base.
- All persons are in the clear before moving the machine. Do not operate the machine on a ROW until all workers are in the clear.
- Stop the engine and shut down equipment before making repairs or greasing the machine.

### **Backhoes**

- Before using the loader, be sure the backhoe is in the transport lock position.
- Do not use the bucket as a work platform or personnel carrier.
- Carry the backhoe bucket low to avoid obstructed vision and to maintain maximum stability while traveling.

- Do not operate equipment if anyone is within the backhoe swing pivot area.
- Drive straight up and down the slope.
- Avoid turning on a slope if possible.
- If necessary, make a wide, slow turn on the slope and carry the bucket low.
- Driving across a steep slope is prohibited.
- Swing the bucket to the uphill side to drop the spoil, if possible, when operating on a slope.

#### **Loading / Unloading Equipment:**

- Always follow the procedures recommended by the manufacturer to load equipment.
- Truck and trailers are of adequate size and weight capacity for the piece of equipment to be hauled.
- Trailer is parked on level stable ground.
- Do not park the truck, trailer, or lowboy under power lines for loading / unloading.
- Brakes are set on the transport and the wheels are chocked.
- Use a Spotter and do not load or unload equipment on a truck, trailer, or lowboy alone.
- Once equipment has been loaded it must be properly secured using a minimum of four tie downs.
- All accessory equipment such as booms, blades, buckets, bush hogs, etc. must be completely lowered and secured.

#### **Contractors shall ensure that Workers:**

- Inspect all mechanized heavy equipment prior to each use.
- Utilize HS-300 Mobile Equipment Pre-Movement & Spotter Guideline
- Always operate mechanized equipment in a safe manner.
- Operate equipment only after receiving training and demonstrating a complete understanding of the safe work practices to be followed while operating equipment.
- All Workers in the general area shall wear High Visibility Safety Apparel (HVSA) in accordance with the PPE section.
- Remove all keys when the machine is unattended and not in use.
- Wear required PPE.
- Seat belts must always be used.
- Assure that site conditions (e.g., grades, weather, and electrical lines and other physical obstructions) are conducive to safe equipment operation prior to equipment use.
- Before moving a load, verify that:
  - Cables, chains, slings, and other attachments are properly applied and secured, and safety latches are functional on all hooks.
  - Load is properly balanced and free from entanglement.
  - No one is in danger of injury from movement of the load or line.
- Do not allow anyone to work or stand underneath loads suspended from lifting or digging equipment.
- Allow only one Worker to give signals to the equipment Operator. The Operator must obey a “stop” signal given by anyone.

- All personnel approaching operating equipment must establish eye contact with the equipment Operator and have the Operator acknowledge that they indeed see them.
  - This practice shall be exercised from a safe distance of at least 6 m (20 ft.) away from the equipment.

## 5.34 Personal Protective Equipment (PPE)

### **Contractors shall ensure that:**

- Review applicable and most recent location-specific PPE Hazard Assessments when conducting Pre-job Safety Meetings.
- Provide Workers with required PPE and the appropriate training to perform duties in compliance with this section.
- Workers and Visitors wear the proper PPE.
- PPE requirements are reviewed with visitors to the site.
- Each project shall conduct an initial PPE Hazard Assessment using a PPE hazard assessment form to determine if current or potential hazards are present which require using PPE.
- Additional hazard assessments will be performed at all worksites to determine if hazards are present or are likely to be present which necessitates the use of additional task specific PPE.
  - If such hazards are identified, Affected Workers must have and use the type of PPE that will protect them from the hazards identified.
- Workers shall be aware of all additional PPE requirements and observe sign postings when hazards are present.
- When PPE is specified for certain work assignments or locations, its use is mandatory.
- Records of PPE hazard assessment and reassessments are required to be kept for the life of the project.

### **Contractors shall ensure that Workers:**

- Maintain PPE in a sanitary and reliable condition.
- Store PPE in a manner that protects against dust, sunlight, heat, extreme cold, excessive moisture, chemicals exposure and physical damage.
- Wear Contractor provided PPE when potentially exposed to workplace hazards and when required by this section.
- Inspect their PPE routinely; if equipment is found to be defective it shall be removed immediately.
- Report PPE malfunctions to Supervisors or another appropriate person.
- Visiting facilities belonging to another Company will adhere to the PPE requirements in force at that facility.
- Demonstrate an understanding of the following:
  - Selecting the appropriate PPE to control identified hazards.
  - When to use PPE.
  - Limitations of various types of PPE.
  - How to don, doff, adjust, and wear the PPE.
  - Proper care, maintenance, and useful life of PPE.
- Workers shall be re-trained when:
  - Changes in the workplace render previous training obsolete.
  - Changes are made to the Worker's job requiring new PPE.
  - Changes in the types or manufacturer of the PPE.



## **Hard Hats**

- In the USA, Hard hats shall meet: ANSI Z89.1, Type 1, Class E.
- Each hard hat must be marked with the information specified by ANSI Z89.1 for that type of protector and for the hazard involved.
- Always wear an approved, industrial hard hat while on Company property, such as in gas processing plants, gas treating stations, compressor stations, on offshore platforms, on pipeline ROWs, and at other pipeline facilities such as meter stations, pig launchers and receivers, tank batteries, etc.
- Never alter or modify the shell or suspension of the hard hat (drill holes in, paint, etc.).
- Hard hats shall be worn properly – as the manufacturer intended (e.g., not turned backwards unless manufacturer has designed hard hat to be worn this way).
- Regularly inspect hard hats and replace at the first sign of. Color fading, breakage, cracks, crazing, discoloration, flaking, delamination, chalky appearance, stiffness/brittleness.
- Follow the maximum recommended replacement schedule by the manufacturer (replace sooner if hard hat condition dictates).
- Hard Hat Exemptions:
  - Hard hats do not need to be worn when sheltered in a motor vehicle, helicopter, cabin of a boat, equipment with enclosed cabs, buildings or break areas (unless otherwise posted or if exposed to head contact hazards).
  - Hard hats are optional for Workers actively engaged in welding or when wearing an SCBA when the site Hazard Assessment indicates that overhead and falling object hazards are controlled or not present.
  - A hard hat exemption may be granted for specific tasks based on the hazard assessment for that task and approved by the Company Project Manager. With this exemption, hard hats must still be worn when reasonably practical.

## **Helmets**

- Motorcycle helmets shall be worn while operating all-terrain vehicles (ATVs), utility terrain vehicles (UTVs) and Snowmobiles.
  - Hard hats may be worn while riding on UTVs (equipped with ROPS and seat belts):
    - within fenced facilities or
    - outside fenced facilities while on level, improved roadways
  - Helmets are required while riding on UTVs in all other conditions
  - Workers required to enter work areas or perform work activities where they are exposed to head contact hazards must remove helmets and wear approved hard hats, unless actively operating an all-terrain vehicle.
- Motorcycle helmets are not approved industrial head protection and are not acceptable as substitute protection.

## **Eye and Face Protection:**

- Eye and face protection must meet either ANSI Z87.1 (US) standard.
- Workers will wear safety glasses while performing work in a plant, compressor station, pipeline facility or ROW location, shop and on a platform.

- All Workers must meet the Minimum Requirements for Eye and Face Protection when carrying out the listed activities that present eye and face hazards.
- Workers are not required to wear safety glasses while sheltered in the office or break area, warehouse (unless a hazard assessment identifies a risk of eye injury), living quarters or a motor vehicle.
- Safety glasses with side shields or goggles will be worn when working with compressed air. A face shield is also recommended.
- Safety glasses with side shields or goggles will be worn when operating air tools. Depending on the work being performed, a face shield may also need to be worn (e.g., chipping, grinding, and brushing).

**Table 15: Minimum Requirements – Eye and Face Protection**

<b>ACTIVITY</b>	<b>EYE AND FACE PROTECTION REQUIRED</b>
Abrasive blasting	<ul style="list-style-type: none"> <li>• Blasting hood</li> </ul>
Chipping, hammering metal, sledge hammering, jack hammering, using compressed air, operating gas, electric or hand saws, concrete work	<ul style="list-style-type: none"> <li>• Safety glasses with side shields, or</li> <li>• Impact goggles</li> <li>• Face shield as needed</li> </ul>
High-voltage work	<ul style="list-style-type: none"> <li>• Face shield<sup>1</sup> (switching hood recommended over 5 KV), and</li> <li>• Safety glasses with side shields</li> </ul>
Low-voltage work	<ul style="list-style-type: none"> <li>• Safety glasses with side shields</li> </ul>
Removing asbestos materials	<ul style="list-style-type: none"> <li>• Face shield and safety glasses with side shields, or</li> <li>• Goggles or</li> <li>• Full face respirator</li> </ul>
Handling liquid hazardous substances (e.g., toluene, NGL, wet cell batteries)	<ul style="list-style-type: none"> <li>• Chemical splash goggles, and any additional protective equipment indicated on container labels or SDSs</li> <li>• Face shield when handling large quantities, exposed to liquid spray, or transferring liquids</li> </ul>
Mowing	<ul style="list-style-type: none"> <li>• Safety glasses with side shields</li> </ul>
Operating chainsaws, using weed trimmers	<ul style="list-style-type: none"> <li>• Face shield or safety glasses with side shields, or</li> <li>• Impact goggles</li> <li>• Mesh face shields are recommended when operating chainsaws</li> </ul>
Arc Welding	<ul style="list-style-type: none"> <li>• Welder <ul style="list-style-type: none"> <li>○ Welding helmet and safety glasses with side shields,</li> <li>○ Welding mono-frame goggle.</li> </ul> </li> <li>• As per OSHA 1910.252, shaded lenses must be shade 10-14 based on type of welding, shade 4 – 8 for gas welding</li> <li>• Helper <ul style="list-style-type: none"> <li>○ Same as above</li> <li>○ Face shield along with shaded<sup>2</sup> safety glasses with side shields, or</li> </ul> </li> </ul>

ACTIVITY	EYE AND FACE PROTECTION REQUIRED
	<ul style="list-style-type: none"> <li>○ Face shield and shaded2 welder/cutter goggles.</li> </ul>
Oxy-acetylene welding, brazing or soldering or cutting,	<ul style="list-style-type: none"> <li>● Welder                             <ul style="list-style-type: none"> <li>○ Welding helmet and safety glasses with side shields, or</li> <li>○ Face shield and shaded2 safety glasses with side shields, or</li> <li>○ Shaded2 mono-frame welder/cutter goggles.</li> </ul> </li> <li>● Helper—same as Welder</li> </ul>
Wire brushing, buffing, grinding (electric and pneumatic), cut-off saws and concrete saws	Standard: Hi-Impact Z87 (US) <ul style="list-style-type: none"> <li>● In the US, Face Shields and</li> <li>● Safety glasses with side shields</li> </ul>
Working in windy conditions	<ul style="list-style-type: none"> <li>● Protection as required</li> </ul>

NOTES: Face shield should have dielectric properties and ultraviolet protection. Minimum shade of three (3).

**Prescription Safety Glasses/Contact Lens:**

- Contact lenses are permitted if:
  - Appropriate eye protection is worn.
  - Workers inform their Supervisors so that proper care may be administered in an emergency. Polycarbonate, plastic, and glass lenses must be marked in accordance with ANSI Z-87.1, *Industrial Eye and Face Protectors*.

**Hearing Protection – Requirements**

- Hearing protection devices with a minimum Noise Reduction Rating (NRR) of 25 dBA shall be furnished by the Contractor and must always be properly worn within areas posted as “hearing protection required” areas, and in areas where sound levels exceed 85 dBA. Examples include but are not limited to:
  - Operating jack hammers
  - Lawn mowers
  - Lawn trimmers
  - Other high noise level equipment.
- Dual hearing protections (ear plugs and earmuffs) must be worn in areas where sound levels exceed 100 dBA. Examples include but are not limited to:
  - Working in compressor rooms
  - Operating air compressors.

**Hand Protection – Requirements**

- The Contractor provides the appropriate type of hand protection for all work activities.

- Contractor shall follow Hand Protection Specifications or other Company policies on hand protection.
- Supervisors will arrange for the appropriate hand protection.
- All Workers must meet the minimum requirements for hand protection when carrying out the listed activities that present a hazard to the hands (see table below).

**Table 16: Minimum Requirements for Hand Protection**

ACTIVITY	HAND PROTECTION REQUIRED
High-voltage work	<ul style="list-style-type: none"> <li>• ANSI/ASTM-approved rubber gloves of appropriate voltage rating worn under leather gauntlet gloves<sup>1</sup></li> </ul>
Low-voltage work	<ul style="list-style-type: none"> <li>• ANSI/ASTM-approved rubber gloves of 1000 volt rating worn under protective leather gauntlet gloves<sup>2</sup></li> </ul>
Handling acids or caustics (including acid batteries)	<ul style="list-style-type: none"> <li>• Neoprene or nitrile gloves</li> </ul>
Handling NGL (risk of spray)	<ul style="list-style-type: none"> <li>• Neoprene gloves and protective sleeves</li> </ul>
Handling pipe, valves and casing, and measuring equipment where exposed to induced voltage	<ul style="list-style-type: none"> <li>• ANSI/ASTM-approved low voltage lineman’s rubber gloves and protective leather gauntlets</li> </ul>
Handling toluene	<ul style="list-style-type: none"> <li>• Nitrile gloves</li> </ul>
Vibrating/high impact equipment	<ul style="list-style-type: none"> <li>• Vibration-dampening gloves</li> </ul>
Washing and cleaning using detergents.	<ul style="list-style-type: none"> <li>• Rubber gloves</li> </ul>
Welding and associated activities	<ul style="list-style-type: none"> <li>• Leather gauntlet-type gloves</li> </ul>

*NOTES: Rubber gloves must be at least 450 mm (18 in) long and extend 25 mm (1 in) past the leather gauntlet for every 10,000 V. Gloves may not be necessary if insulated hand tools rated at 1000 V are used. The leather gauntlet gloves may be removed if finger dexterity is required and the rubber gloves are not subject to damage.*

- Wear appropriate hand protection when there is potential exposure to induced high voltage, including when handling pipe, valves, casing or measuring equipment.

**Foot Protection – Requirements**

- Safety footwear must comply with the following standards:
  - **In the USA**, ASTM F2413
- Each pair of footwear must be marked with the information specified by the above-mentioned standards for each specific type of footwear.
- Athletic looking shoes, including those meeting either ASTM F2413 (US) are not allowed at a Company worksite.
- Always wear approved, safety toed (steel or non-metallic) work footwear while in a plant, compressor station, pipeline facility and on a platform.
- Canvas or synthetic fiber cloth shoes are prohibited footwear for Workers working in non-office environments and are not allowed.
- Safety toed; work footwear does not need to be worn when sheltered in:

- Control rooms, lunchrooms, living quarters, offices
  - Motor vehicle, boat, helicopter
- Consider the work environment and the potential for foot or ankle injury when choosing a type and style of safety footwear.
- The work environment shall determine the choice of:
  - Shoes or boots (ankle support, hot or cold environment),
  - Sole, e.g., puncture resistant, nonskid, stitched vs. vulcanized, cold resistant, electric shock-resistant, chemical resistant.
  - Fastenings (e.g., laced versus unlaced, closed top versus open top),
  - Accessories (e.g., metatarsal plate).
- Protective footwear should be replaced if:
  - Soles are worn so that the slip resistance of the footwear has been drastically reduced.
  - Soles are cracked, leather is cut, or toe caps are exposed as this damage reduced the protective qualities of the footwear.
- Workers and visitors on a supervised or controlled tour of a facility, or whose occasional visits are of an administrative nature may be exempt from the requirement for safety footwear, but only if they do not have the potential to be exposed to any hazard.
- During protective footwear purchases, Workers should consider other H&S risk as identified from the project specific PPE Hazard Assessment. The identified risk can be mitigated by other available protective footwear features designed into. These features include, but are not limited to:
  - Electrical hazards (EH)
  - Slip resistant (SR)
  - Non-metallic toe cap (NU)
  - Puncture resistant (PR)
  - Waterproof
  - Metatarsal guard (MG)
  - Firm ankle support (6-in /15 cm shoe top)
  - 1.3 cm (½-in) heels
- Project-specific PPE Hazard Assessment may require special footwear for unusual jobs. In these special cases the footwear will be provided by the Contractor. These unusual jobs and/or activities may include, but not limited to:
  - Rubber knee or hip length boots
  - Rubber pull over booties for electrical hazards
  - Special weather conditions (cold weather and ice)
  - Chemical resistant boot covers

### **High Visibility Safety Apparel (HVSA) Requirements**

- All HVSA worn shall meet the performance requirements for Class 2 (or Class 3 for identified tasks below) of the ANSI / ISEA 107 American National Standard for High-Visibility Safety Apparel and Headwear.
  - Class 3 HVSA shall for worn:
    - When working on or next to roadways with traffic speeds above 80 km/hr. (50 mph),
    - By traffic control personnel, and
    - As determined by the hazard assessment.
- HVSA can include:
  - Vests
  - Shirts
  - Jackets or coats
  - Coveralls
- HVSA shall be worn when performing work tasks:
  - Where there is exposure to vehicle traffic such as on the ROW of a private, county, state or federal road or highway.
  - At a construction site where heavy equipment, such as cherry pickers, backhoes, track hoes, etc. are being utilized.
  - As the designated Signaler or Spotter.
- Flame-resistant (FR) high visibility vests are required (when exposed to vehicle traffic) when in the immediate area of the above defined section on Specific Hazards that Require FR.

### **Protective Clothing – Requirements**

- Disposable chemical protective gear used in FRC specified areas must also be flame resistant.
- When working around rotating or reciprocating machinery, observe the following precautions:
  - Ensure gloves, ties, and loose clothing does not become entangled in equipment. Button or properly roll up long sleeves and tuck in shirt tails.
  - Do not wear loose jewelry (e.g., necklaces, chains, cords) outside clothing.
  - Drawstrings on clothing (e.g., hoodies) shall be removed to prevent risk of entanglement.
  - Long hair shall be tied back or otherwise secured to prevent any risk of entanglement.
- Do not wear, do not store with food, do not launder with other clothing or store with clean clothing any personal or protective clothing that becomes saturated with oil, solvents, or hazardous or toxic substances.

**Table 17: Requirements for Protective Clothing**

ACTIVITY	BODY PROTECTION REQUIRED
Handling NGL (risk of spray)	<ul style="list-style-type: none"> <li>• Neoprene apron</li> </ul>
Removing asbestos materials	<ul style="list-style-type: none"> <li>• Disposable hooded coveralls (preferably Tyvek brand) with elastic fittings</li> <li>• Rubber boots or disposable boots (preferably Tyvek brand)</li> <li>• Elasticized shoe covers</li> </ul>
Steam cleaning or high-pressure washing	<ul style="list-style-type: none"> <li>• Rubber apron or slicker suit</li> <li>• Rubber boots</li> </ul>
Handling acids, caustics or other hazardous chemicals (large quantities)	<ul style="list-style-type: none"> <li>• Neoprene or nitrile apron or slicker suit</li> </ul>
Operating chainsaws	<ul style="list-style-type: none"> <li>• Approved leg chaps</li> <li>• Heavy pants</li> <li>• Long-sleeved jacket or shirt</li> </ul>
Mowing and weed trimming	<ul style="list-style-type: none"> <li>• Heavy pants</li> <li>• Long-sleeved jacket or shirt</li> </ul>
Abrasive blasting	<ul style="list-style-type: none"> <li>• Heavy pants,</li> <li>• Long-sleeved jacket or heavy shirt</li> </ul>
PCB Exposure	<ul style="list-style-type: none"> <li>• Suitable chemical and/or oil resistant gloves (see the glove manufacturer's specifications for suitability)</li> <li>• Goggles if there is potential for a chemical or oil splash hazard</li> <li>• Protective clothing such as a coverall or work apron</li> </ul>
Spill Clean-up	<ul style="list-style-type: none"> <li>• Level A, B, C, or D as designated by the Incident Commander</li> </ul>
Welders and welder's helpers (radiant energy)	<ul style="list-style-type: none"> <li>• Heavy pants,</li> <li>• Long-sleeved heavy shirt</li> </ul>
High voltage electrical equipment maintenance, service, repair, testing and operation	<ul style="list-style-type: none"> <li>• Flame-Resistant Clothing</li> </ul>

**Flame-Resistant Clothing (FRC):**

- **Approved FRC:** Flame resistant clothing (FRC) that meets the performance requirements of the following standards.
  - NFPA 2112 Standard on Flame-Resistant Garments for Protection of Industrial Personnel Against Flash Fire
  - ASTM F2733 Flame-Resistant Rainwear for Flame Hazards
  - ASTM F1891 Standard Specification for Arc and Flame-Resistant Rainwear
  - CAN/CGSB-155.21-2001 Recommended Practices for the Provision and Use of Workwear for Protection Against Hydrocarbon flashfire; or

- CAN/CGSB-155.20 Workwear for Protection against Hydrocarbon Flash-fire.
- FRC is required for all Workers working in hazardous/classified locations.
- Workers and Visitors must wear FRC inside fenced or operating facilities or where hot work is being performed on the Right of Way (ROW), or as required by an assessment of the task hazards.
- Contractors shall provide FRC in a sufficient number and style to protect workers and Visitors.

### **Specific Hazards that Require FR**

- Working within 4.6 m (15 ft.) of a planned release of flammable liquids or gases to the environment including but not limited to:
  - Pipeline and facility release during gas blowdowns, gas evacuations and gas purges
  - Blowing down valve bodies
  - Blowing down, evacuating, and purging launchers and receivers
  - Installing leak clamps
  - Gas handling work within a station site
- Working in areas where there is a risk of an unintentional release of flammable liquids or gas, including but not limited to:
  - During a leak investigation when working within the vicinity of the expected leak
  - During repairs to damaged pipeline
  - Assembling and disassembling truck connections for flammable liquid transfer
  - Removing or inserting a pig into a pig barrel
  - While installing a stopple or hot-tap
  - During hot and cold cutting of live lines
  - When working within 4.6 m (15 ft.) of an operating air mover that is being used to pull potential leaking gas away from a work area
- Performing or monitoring hot work under the issuance of a hot work permit or when entering a classified area where a hot work permit has been issued.
- Working in a Greenfield construction area where there is a potential risk of unintentional release.
- For electrical equipment operations, maintenance, service, repair and troubleshooting please refer to electrical safety for additional FRC requirements.
- Any work in a known flammable atmosphere with 10% LEL or greater.
- Any work where an assessment of the task hazards deems the use of FR clothing as a requirement.

### **Wearing FRC**

- FR clothing shall be worn and maintained accordingly:
  - FRC shall be worn as described in the manufacturer's instructions. FRC should be inspected, laundered, repaired and/or taken out-of-service per the manufacturer's recommendations.
  - Long sleeved FRC shall be worn in designated FRC areas / jobs.



- o Workers shall wear FRC as the outer-most garments except when other personal protective clothing is required. Only approved FR outerwear is permitted to be worn over flame-resistant garments.
  - o Workers should not wear synthetic blends such as nylon, polyester, rayon, polyethylene, etc. under the FRC. Only natural fibers such as 100% cotton or wool or FR are recommended to be worn underneath FRC.
  - o FRC shall be worn in such a manner as to completely cover the torso, arms and legs (sleeves rolled down, shirt tucked in and body fully zipped or buttoned up). In addition, appropriate hand protection the appropriate gloves should be worn whenever FRC is required. FR smocks are not allowed.
  - o Where there is a risk of exposure to heat stress, FRC should be constructed of lighter weight FR materials.
- The table below lists the acceptable styles of FRC.

**Table 18: Acceptable Flame-Resistant Clothing Styles**

FIRE RESISTANT CLOTHING	EXAMPLES
Shirts	<ul style="list-style-type: none"> <li>• Long sleeve FRC shirts.</li> </ul>
Pants	<ul style="list-style-type: none"> <li>• Long FRC pants or FRC denim.</li> </ul>
Coveralls	<ul style="list-style-type: none"> <li>• Long sleeve FR coveralls may be worn as a single layer. When worn over FRC or non-FRC, they will provide more protection.</li> </ul>
Bibs	<ul style="list-style-type: none"> <li>• FRC bibs must be worn in conjunction with an upper level of FRC (i.e. FRC long sleeve shirt or FRC jacket).</li> </ul>
Jackets	<ul style="list-style-type: none"> <li>• FRC Jackets may be worn lined or unlined. If the lining is FRC, it may be worn as outerwear.</li> </ul>
Other	<ul style="list-style-type: none"> <li>• Rainwear, High Visibility Vest, Welders Aprons, etc.</li> </ul>

**Laundering, Care and Inspection**

- FRC must be kept clean and in good condition.
- FRC that is damaged, torn, or threadbare must be repaired in accordance with the manufacturer’s instructions or retired.
- Soiled or contaminated FRC shall be removed from service and cleaned.
- Keep FRC reasonably free from grease and oil.
- Do not use chlorine bleach when laundering FRC.
- FRC shall be laundered or dry-cleaned in accordance with the manufacturer’s instructions.
- FRC should be systematically inspected before each use for damage, soiling or contamination.

**Task Specific PPE Requirements:**

**Working with UAS**

- The pilot and visual observer are required to wear the following personal protective equipment:
  - o Approved safety footwear,

- Class 2 HVSA to distinguish themselves from other workers,
- Approved hard hat with a chin strap,
- Face shield or safety goggles where dust and flying debris may be present, and
- First Aid kit.

### **Operating Mowers / Weed Eaters**

- When operating mowers and weed eaters, wear hearing protection, safety glasses with side shields, steel toed footwear and heavy pants with a long-sleeved shirt.

### **Working from Aerial Lift Bucket**

- When working from an aerial lift bucket requires the use of a full body harness with a lanyard attached to the designed point on the bucket.

### **Welders and Welder's Helpers**

- All Welders and Welder's Helpers should wear clothing that will provide sufficient cover and is made of suitable materials that will minimize skin burns caused by sparks, spatters and radiation.
- All Welders and Helpers should wear leather gauntlet-type gloves with seams on the inside to prevent stitches from burning.
- Welding helmets or mono-frame goggles shall protect the face, forehead, neck, ears, and eyes.
- Goggles, with the appropriate filter shade (at least 3), or a welding helmet shall be worn during oxyfuel gas welding and cutting operations.
- Welders and Helpers should take precautions to avoid breathing the fume plume by positioning the work where it is not directly under their face, or by ventilation.
- If need be, an air purifying respirator may be worn.

### **Operating Off-Road Equipment**

- When operating off-road equipment, the Operator, and any passengers (if allowed by the manufacturer) must wear:
  - Appropriate hearing protection.
  - Wear appropriate eye protection – safety glasses at a minimum unless wearing a full-face helmet.
  - Clothing suitable for the operating conditions and environment (long sleeves and long pants to ankles and wrists).
  - Approved motorcycle helmet (a full-face helmet is recommended as it provides protection to the jaw area) must be worn.
  - Hard hats may be worn when operating within a Company facility fencing when traveling on smooth roadways at speeds under 15 km/hr.
- Ensure that adequate clothing is worn to provide protection from weather conditions.

### Using Electrical Power Tools

- When using electric power tools, wear safety glasses with side shields and no loose clothing.

### Operating a Chain Saw

- When operating a chain saw, wear hard hat and hearing protection, safety glasses with side shields and face shield, safety toed footwear, gloves, and heavy pants with long-sleeved shirt.

### Arc Flash PPE for Electrical Work

- For electrical work, test and check voltage rated rubber gloves.
- General electrical PPE requirements are illustrated in the figure below.

**Table 19: Voltage-Rated Rubber Gloves**

<b>CLASS</b>	<b>USE</b>
Class 00	Use for circuits up to 500 volts AC
Class 0	Use for circuits up to 1000 volts AC
Class 1	Use for circuits up to 7,500 volts AC
Class 2	Use for circuits up to 17,000 volts AC
Class 3	Use for circuits up to 26,500 volts AC
Class 4	Use for circuits up to 36,000 volts AC

<h2 style="text-align: center;">ARC FLASH PPE GUIDE</h2> <p style="text-align: center;"><b>Guidance on Selection of Arc-Rated Clothing and Other PPE for Use When Incident Energy Exposure is Determined</b>  <small>For more detailed information or other options refer to NFPA 70E 2015 Edition, Table H.3(b) or CSA Z462 Table H.2</small>                      FR Garments for electrical workers shall meet the minimum ATPV of 8 cal/cm<sup>2</sup> (HIRC 2) and increase as required by Arc Flash Hazards. Workers should wear only clothing made with a natural fiber (e.g., cotton, wool) or approved FR undergarments below FR outerwear.</p>		
<p><b>Incident Energy Exposure</b> <b>&lt; 1.2 cal/cm<sup>2</sup></b></p>	<p>Untreated natural fiber                      Shirt (long sleeve)                      Pants (long) or coverall                      Face shield for projectile protection (as needed)                      Safety glasses or safety goggles                      Hearing protection                      Heavy-duty leather gloves or rubber insulating gloves with leather protectors (as needed)</p>	
<p><b>Incident Energy Exposure</b> <b>≥ 1.2 to 12 cal/cm<sup>2</sup></b></p> <p>Arc-rated clothing and equipment with an arc rating equal to or greater than the determined incident energy*</p>	<p>Arc-rated long-sleeve shirt                      Arc-rated pants or arc-rated coverall or arc flash suit                      Arc-rated face shield and arc-rated balaclava or arc flash suit hood                      Arc-rated jacket, parka, or rainwear (as needed)                      Hard hat                      Arc-rated hard hat liner (as needed)                      Safety glasses or safety goggles                      Hearing protection                      Heavy-duty leather gloves or rubber insulating gloves with leather protectors                      Leather footwear</p>	
<p><b>Incident Energy Exposure</b> <b>&gt; 12 cal/cm<sup>2</sup></b></p> <p>Arc-rated clothing and equipment with an arc rating equal to or greater than the determined incident energy*</p>	<p>Arc-rated long-sleeve shirt                      Arc-rated pants or arc-rated coverall and/or arc flash suit                      Arc-rated arc flash suit hood                      Arc-rated jacket, parka, or rainwear (as needed)                      Hard hat                      Arc-rated hard hat liner (as needed)                      Safety glasses or safety goggles                      Hearing protection                      Arc-rated gloves or rubber insulating gloves with leather protectors                      Leather footwear</p>	

\*Arc ratings can be for a single layer, such as an arc-rated shirt and pants or a coverall, or for an arc flash suit or a multi-layer system consisting of a combination of arc-rated shirt and pants, coverall, and arc flash suit.

12/10/2015

Figure 6: Arc Flash PPE Guide

## **Personal Flotation Device (PFD) – Requirements:**

### **Working Over or Near Water**

- Workers working over or near water, where the danger of drowning exists, will be provided with a PFD such as U.S. Coast Guard approved life preserver or buoyant work vest except when using a safety harness and lanyard or lifeline.
- Work vest will be stored in a separate location from life preservers.
- Prior to and after each use, PFDs shall be inspected for defects which would alter their strength or buoyancy.
- Defective units will not be used and will be replaced.
- A PFD will be worn when:
  - Riding in a boat other than in an enclosed cabin
  - Transferring from a boat to or from the platform or dock
  - Working in areas above the water such as barges, bottom walkways, and decks without a guardrail or if working outside a guardrail
  - Descending to the Plus 12 Level (lowest deck) of an offshore platform
- Entry into the water shall only be permitted when:
  - A diver is to perform specific work
  - An abandon platform order is given

### **Offshore Specific**

- An approved life preserver will be provided for each person on manned and un-manned platforms.
- The life preservers will be stored in easily accessible places.
- Each life preserver will have a personal flotation device light securely attached to the front shoulder area of the life preserver.
  - Replace the light or the replaceable power source for the light before its expiration date.
- Each life preserver will have retro-reflective material attached on its front side and back side and on each of its reversible sides.
- All life preservers will be marked with the name or number identifying the facility on which placed.
- Ring Life Buoys
  - Ring life buoys with at least 23 m (75 ft.) of line will be provided and readily available for emergency rescue operations.
  - Each manned and un-manned platform will have at least four approved ring life buoys.
  - One ring life buoy will be placed on a suitable rack on each side of a manned platform in an accessible place.
  - The ring life buoys will always be capable of being cast loose and may not be permanently secured in any way.

- Each ring life buoy will have a water light attached to the ring life buoy by a 12-thread manila or equivalent synthetic lanyard not less than 1 m (3 ft.) nor more than 2 m (6 ft.) in length.
- All ring life buoys will be marked with the name or number identifying the facility on which placed.
- Life Rafts
  - Life rafts will be provided for emergency rescue and abandonment operations.
  - The equipment required for a life raft is:
    - Boat hook
    - Life line
    - Paddles and steering oar
  - All life rafts, together with paddles or oars, will be marked with the name or number identifying the facility on which placed.

### **Performing a Line Break/In Immediate Area of a Line Break or Equipment Opening**

- Workers must use the following if performing a line break or equipment opening or are working in the immediate vicinity of the line break:
  - Fire-resistant (FR) clothing as an outer layer, worn as directed by manufacturer (e.g., buttoned up, sleeves rolled down, etc.).
  - Respiratory protection during the initial line break or opening until isolation is proven and work area has proven safe atmosphere.
    - The level and type of respiratory protection is based on the potential composition, volume, and pressure of the gas or vapor that may potentially be released during the break or opening.
    - When opening systems where a known potential for exposure exists, all Workers in the immediate work area shall wear the appropriate RPE, in accordance with the completed Hazard Assessment until a safe atmosphere has been verified.
    - If the composition and/or concentration of the contaminant is unknown or there is a potential for a Hazardous Atmosphere, assume the atmosphere is hazardous, perform exposure assessments and use RPE in accordance with the Respiratory Protection section of this manual.
- If there is a potential for an atmosphere above 5 ppm of H<sub>2</sub>S (>5ppm H<sub>2</sub>S) or an oxygen level below 19.5% in the Worker's breathing zone during the job:
  - Workers must use supplied air (SCBA or SABA) as respiratory protection.
  - A Safety Watch out of range of a toxic atmosphere but within sight of the worker(s) must be used.
  - The Safety Watch must don SCBA or SABA but does not need to put on mask unless performing a rescue.

### **Pigging Operations**

- FR clothing as an outer layer, worn as directed by manufacturer (e.g., buttoned up, sleeves rolled down, etc.)
- Gloves and eyewear (and if required additional splash protection PPE) that sufficiently protect against the products or materials that contaminate pigs or collect and/or flow from barrels.
- Personal gas monitors (PGMs) and/or portable area monitors are required to establish LEL and other toxic levels as part of opening and closing procedures.

## 5.35 Pigging

### **Contractors shall ensure that:**

- Pigging operations are performed as per the local Company procedure and plan in coordination with Company Gas Control / Control Rooms as applicable and required.
- Apply hazard controls outlined in the requirements below including:
  - Avoiding the line of fire created by the barrel and door.
  - Preventing ignition sources in the hazardous location when barrel door is open.
  - Wearing applicable respiratory protection, FRC and other required PPE.
  - Making use of gas monitors to establish a safe atmosphere.
- Contractors conducting pigging operations must have a written procedure that sets out the following minimum requirements:
  - Detailed operational steps.
  - Hazards and controls required for each step (as well as any general hazards and controls that apply)
    - This includes hazards arising from pressures, known product, or residual products that may be captured by pigs (e.g., iron sulfides)
  - Full instructions on communication requirements (e.g., with Company Gas Control, Control Room, adjacent facilities, or operations, etc.).
- Pigging operations may only be conducted by or under the immediate supervision of a worker trained and qualified to perform the particular pigging operation.
- Where permitting requirements apply (e.g., Safe Work Permits or environmental permits, etc.), these must be completed and be made available on site as applicable.
  - Where hand wheel valve operations are required or potentially required in the pigging procedure, any requirements regarding these should be specified in the procedure to ensure operator and equipment safety, including consideration such as:
    - Correct isolation of motor operator valve when using a hand wheel to prevent unintended engagement of the motorized valve when an operator uses the hand wheel.
    - Requirements to remove hand wheels following operations as applicable.
- Avoid the line of fire generated by the pig receiving or sending barrel and the barrel door. This includes:
  - Minimizing activity in front of the door and ensuring individuals are not in the line of fire when barrel is being pressurized during sending or receiving activities.
  - When practical, standing on the side of the pig barrel opposite of the closure hinges. This is especially the case when first opening the barrel.
  - Ensuring any non-essential personnel are not near the pig loading/receiving operation. At minimum, this should include the 8 m (25 ft.) perimeter from the barrel door (see hazardous area requirements below).



- The pigging crew must have assurance that the pigging barrel is fully vented, and all pressure fully blown down prior to opening the pig barrel door.
- Pressure gauges (where installed) to ensure depressurization should be consulted and must be functioning and of suitable resolution and accuracy to ensure full depressurization before opening.

### **Contractors shall ensure that Workers:**

- For respiratory protection during the initial opening of the barrel and until work area has proven safe atmosphere:
  - The level and type of respiratory protection shall be based on the potential composition, volume, and pressure of the gas or vapor that may potentially be released during the break or opening.
  - When opening systems where a known potential for exposure exists, all Workers in the immediate work area shall wear the appropriate RPE, in accordance with the completed Hazard Assessment until a safe atmosphere has been verified.
  - If the composition and/or concentration of the contaminant is unknown or there is a potential for a Hazardous Atmosphere, assume the atmosphere is hazardous, perform exposure assessments and use RPE in accordance with the Respiratory Protection section of this manual.
  - If there is a potential for an atmosphere above 5 ppm of H<sub>2</sub>S (>5ppm H<sub>2</sub>S) or an oxygen level below 19.5% in the Worker's breathing zone during the job:
  - Workers must use supplied air (SCBA or SABA) as respiratory protection.
  - A Safety Watch out of range of a toxic atmosphere but within sight of the worker(s) must be used.
  - The Safety Watch must don SCBA or SABA but does not need to put on mask unless performing a rescue.
- In the event it is necessary for pigging operators to remove their PGM to protect H<sub>2</sub>S heads from damage from overexposure to H<sub>2</sub>S (e.g., in high H<sub>2</sub>S environments where workers perform all open barrel activities with supplied air), an alternative means of measuring LEL hazard needs to be implemented.
- Respiratory protection can only be removed by Workers once a monitor reading establishes a safe atmosphere.
- The area surrounding the pigging barrel must be treated as a hazardous location when the barrel door is open, or any local atmospheric vents are open.
- The size of the hazardous area (Class 1, Division 2 or Class 1, Zone 2 or higher) will be based on an engineering judgment (see the Hazardous Locations defined term in section 13.2) but will never be less than 3 m (10 ft.) from the barrel door or vent opening(s).
- Only essential personnel wearing PPE must be allowed in the hazardous area when the door is open. See Section 4.35 Personal Protective Equipment for PPE requirements.
- Only intrinsically safe tools may be used during opening and closing procedures.
- Catch basins and retrieval apparatuses or devices to retrieve pigs from barrel must be permanently or temporarily bonded when in use to prevent a static charge ignition source.

- Catch basins are required for all pig barrel openings and must be sufficiently cleaned and maintained to protect both workers and the environment.
- Pigging Operators must report any leaking valves upon discovery. Pigging operations using barrels with leaking valves must be suspended pending repair or a further assessment and mitigation strategy approved by area management.
- In the event unsuspected iron sulfide is found, the barrel door should be closed immediately to prevent accidental ignition until a mitigation plan is developed.

## 5.36 Powered Industrial Truck

### **Contractors shall ensure that:**

- Always operate forklifts/trucks as per manufacturer's instructions and in a safe manner. This includes operating the equipment within the pre-established load limits.
- Identify forklifts equipped with front-end attachments other than factory installed attachments with information to show the approximate weight of the forklift and any attachment combination at maximum elevation with load laterally centered.
- Maintain legible nameplates and markings on all forklifts.
- Industrial trucks must not be altered either by the addition of extra parts not provided by the manufacturer or by the elimination of any parts.
- Obtain written manufacturer's approval prior to forklift making:
  - Modifications and additions which affect its capacity and safe operation.
  - Changes affecting capacity, operation, and maintenance instruction plates, tags, or decals.
- Forklifts may only be used in applications and atmospheres according to its design designation.
  - Trucks approved for use in hazardous areas shall have the manufacturer's label or some other identifying mark indicating approval for the intended use by a recognized national testing laboratory (e.g., Underwriters Laboratories [UL] or Factory Mutual [FM]).
  - Durable markers indicating the designation of the type of truck for use in hazardous areas shall be applied to each side of the vehicle in a visible but protected area. These markers shall be distinctive in shape.
- The entrance to hazardous areas shall be posted with a sign to identify the type of forklift truck permitted.
- All forklifts/trucks are inspected annually and before use.
- All forklifts/trucks are maintained in a safe condition. Maintain and inspect forklifts following the frequency as determined by the jurisdictional requirements and the manufacturer's recommendations.
- Only Qualified Personnel are permitted to operate a forklift. All forklift/truck Operators are properly trained to operate the specific equipment which they will be expected to operate and have a valid operator's license/certification.
- Personnel who do not operate a class or forklift for which they were qualified for more than 12 months shall be re-evaluated prior to operating.
- Remove forklifts from service and tag out the unit if a visual examination or inspection shows any condition affecting the safety of the vehicle.
- Repairs must be made by Authorized Personnel with parts equivalent as to safety and the original design. If possible, all Forklift/truck repairs should be made outside of the operating area.
- Locate battery charging installations for battery operated forklifts/trucks in proper designed and designated areas for that purpose.
- Maintain safe clearances, clear aisles, and other facility conditions safe for forklift operation.

- Safe clearances must be allowed for aisles at loading docks, through doorways and wherever turns or passage must be made.

**Contractors shall ensure that Workers:**

- Remove keys when not in use to prevent unintended use by unqualified Operators.
- Keep a valid operator's license/certification card (if applicable) in their possession when required to operate a forklift/truck.
- Inspect and document inspection of the forklift /truck at the start of each shift that the equipment will be used, using Form HSF-060 Powered Industrial Truck Inspection or equivalent.
  - Check the fork pins and stops to make sure that they are in place.
  - Check all cowling and body parts.
  - Check the wheels and tires for excessive wear.
  - Look for any broken or loosened parts.
  - Check the fuel level, crankcase oil level, radiator water level.
  - Check the engine air cleaner, the fan belt, the hydraulic fluid level and the battery water level.
  - Check the hour meter and record it.
  - With the engine running, check operation of the hour meter, headlights, taillights and warning lights.
  - Check the oil pressure gauge, the water temperature, ammeter, and sound the horn.
  - Check and test braking system.
  - Conduct functional test for the lifting/attachment operation being performed.
- Wear the proper required personal protective equipment when operating a forklift/truck.
- Wear seatbelts while operating forklifts and prohibit additional riders on the equipment.
- No person shall be allowed to stand or pass under the elevated portion of any truck, whether loaded or empty.
- Wheels must be blocked if the truck is parked on an incline.
- Never add fuel of any type to the forklift/truck while the engine is running. Keep a fully charged fire extinguisher mounted on the forklift/truck.
- When a powered industrial truck is left unattended, load engaging means shall be fully lowered, controls shall be neutralized, power shall be shut off, keys removed, and brakes set.
- Stunt-driving and horseplay are not allowed.
- Do not move loads with broken pallets or loads beyond the capacity of the forklift or loads that are unbalanced.
- Stack, block, and interlock bags, containers, bundles, and limit the height of storage to ensure stability and security against sliding or collapsing when picking up with a forklift/truck.
- Crib and securely block structural steel, poles, pipe, bar stock and other cylindrical materials stored on the floor or ground.
- When moving loads keep them as low as possible and slightly tilted back.
- If required to unload trailers from a loading dock, ensure the trailer is chocked and if unattached from a tractor, supported with stands.

- Dock board or bridge plates shall be properly secured before they are driven over. Dock board or bridge plates shall be driven over carefully and slowly, and their rated capacity never exceeded.

## 5.37 Public Work Area Traffic Management Guide

### **Contractors shall ensure that:**

- A Traffic Control Plan will be prepared in accordance with the governing jurisdiction's legislative requirements. All required permits, if applicable, must be obtained prior to the commencement of the work.
- The Traffic Control Plan (TCP) takes into consideration the hazards specific to the worksite, such as but not limited to:
  - Evaluating the anticipated traffic patterns
  - Traffic volumes
  - Traffic speeds
  - Alternative routes
  - Changing seasonal conditions – snow, varying amounts of day light, etc.
  - Working hours – Worker fatigue
  - Time / duration of the job (daylight, dusk, high traffic, few hours, multiple days)
  - Project yard or staging area locations
  - Project schedule
  - Duration of the project
  - Changing project conditions
- To develop a Traffic Control Plan the following should be considered:
  - Determine the location of the proposed work area and identify the required degree of encroachment into the roadway.
  - Determine the duration of the work to be undertaken.
  - Evaluate the need for traffic flow control.
  - Select the most appropriate traffic control layout for the work based on the site evaluation and work area requirements.
  - Review the traffic control layout to ensure that all site-specific conditions are adequately accommodated.
  - Plan for the safe movement of pedestrians, cyclists, and other vulnerable road users, ensuring that vehicle and pedestrian movements are separated.
  - Determine schedule of traffic control devices, including sign sizes and quantities in accordance with the local jurisdiction's legislative requirements.
  - For long duration work, determine whether existing pavement markings need to be removed and replaced by temporary pavement markings.
- Roadway work zones should be designed with the following considerations:
  - Worker safety
  - Road user safety (motorist, pedestrian / cyclist, and others)
  - Road user's ability to traverse through the work zone

- Pedestrian paths shall, as far as is reasonably practicable, be separate from vehicle roadways and clearly delineated. Physical separation should be used wherever possible.
  - Advanced warning (provision of advanced notice to road users that they are approaching a work zone)
  - Worksite identification (visible identification of the work area by passive and / or active traffic control devices to show road users where work is taking place)
  - Positive guidance (provision of information to road users required to avoid hazards, when and where this information is needed, will be conveyed using uniform traffic control devices)
- Develop an emergency and incident management traffic control plan, which facilitates emergency vehicle access to work zone locations as necessary.
  - The Company Representative overseeing the work will review, to their satisfaction, the Contractor's Traffic Control Plan prior to work commencing.
  - Ensure that the Traffic Control Plan is understood by all responsible parties before the site is occupied. Any changes to the Traffic Control Plan shall be approved by the Company Representative responsible for the work.
  - Determine if paid duty Officers are required.
  - During the execution of work activities, Traffic Control Devices shall be inspected, at least daily, and the integrity of the Traffic Control Plan reviewed and adhered to. Traffic flow will be monitored, and the traffic plan adjusted as conditions warrant.
  - Mobile digital message boards, where required, should be dispatched to all high traffic entry and exit points (i.e. pipe yard, construction yard, public road way turn offs to projects, etc.) and intersections. The message boards will be positioned and located in accordance with the governing jurisdiction's requirements and will remain in place until the completion of the applicable scope of work.
  - The Contractor Representative will ensure that records of traffic control inspections are kept at the work location and are made available to Company Representatives for review and audit. The following should be considered:
    - Inspect the work zone by driving through it in the daytime and at night, as appropriate, after the temporary traffic control devices for the work zone have been installed.
    - Observe and record actions and reactions of drivers through the work zone (such as speeds, conflicts, late lane changes, frequent breaking).
    - Correct any deficiencies as they are identified and ensure any changes to the Traffic Control Plan are documented.
    - Inspect the work zone traffic control devices over the life of the project, as specified by the governing authority (at least daily), while traffic controls are in effect.
    - Ensure that traffic control devices that are no longer needed, whether on a long-term or short-term basis, are either removed from the roadway, removed to the other side of the shoulder, covered, or turned, so that they are not visible to passing motorists.
  - The Traffic Control Plan is reviewed as part of the Field Level Hazard Assessment (FLHA) or Job Safety Analysis (JSA).

- After work has been completed, reintroducing regular traffic requires controls to ensure the Safety of Workers and the Public.
- Traffic Control Devices will be covered if not required or removed, in the opposite order that they were installed, and in a manner that will not endanger the Workers tasked with their removal.
  - Positive barriers (trucks / jersey barriers) should be maintained where possible.
  - Collect the Traffic Control Devices and disassemble them on the side of the vehicle which is away from the traveled part of the highway.

## 5.38 Respiratory Protection

### Contractors shall ensure that:

- In the USA, provide MSHA/NIOSH certified respirators.
- Respiratory Protection Hazard Assessments are conducted to identify work areas, processes or tasks that require Workers to wear respirators and to determine proper protection is selected for given tasks.
- Respirators are to be selected based on the respiratory hazards to which Workers may be exposed in the workplace. A hazard evaluation must be conducted for each work area where airborne contaminants may be present in routine work or during an emergency. The hazard assessments shall include:
  - Identification and development of a list of hazardous substances used in the workplace by work process.
  - Review of work processes to determine where potential exposures to hazardous substances may occur. This review shall be conducted by surveying the workplace, reviewing the process records, and talking with Workers and Supervisors.
- The hazard assessment must be revised and updated as needed (i.e., any time work process changes may potentially affect exposure). If a Worker feels that respiratory protection is needed during an activity, they are to contact their Supervisor. The potential hazard shall be evaluated. The results of the assessment should be communicated to all affected Workers. This communication must be documented.
- If it is determined that respiratory protection is necessary, all other elements of the respiratory protection program will be in effect for those tasks, and the respiratory section of Contractors plan will be updated accordingly.
- The proper type of respirator for the specific hazard involved will be selected in accordance with the manufacturer's instructions.
- Selection of the types of respirators used for site specific breathing hazards must be made by Contractor supervision.
  - In the USA, see US Guide to Respiratory Protection table.
- The tables mentioned above list the minimum level of respiratory protection requirements for tasks and substances that are (remember, a higher level of protection may be worn):
  - Hazardous to human health
  - Regularly performed by Workers
  - Specific to plant and pipeline operations and maintenance
- For tasks not listed, consult the following regarding the selection of respiratory protection:
  - Safety Data Sheet (SDS)
- The *Respirator Selection Guide* can be used to select the proper respirator for a specific worksite or task. In selecting respirators for individual Workers, the Supervisor shall evaluate the following additional information:
  - Any unusual conditions associated with the work or activity.
  - Anticipated respirators use time.
  - Chemical, physical, toxicological, and warning properties of the air contaminant.



- Air contaminant concentration likely to be encountered.
  - User's ability to seal the selected respirator.
  - User's perceived comfort of the respirator.
- No Worker shall wear a respirator in an atmosphere where the contaminant concentration exceeds the Maximum Use Concentration (MUC) for the respirator being worn.
- If the calculated MUC is higher than any use limitation specified on the NIOSH approval label for the cartridges or filter being used, the concentration appearing on the NIOSH label will take precedence over the calculated MUC.
- Determine Workers who will use Respiratory Protection (i.e., Medical Qualifications, Fit Testing etc.).
- Medical evaluations where required by jurisdiction (frequency of use, potential exposure, and or type of respirator) and respirator training will be completed prior to the fit testing.
  - Workers that are required to obtain medical clearance will not be allowed to engage in work activities or in to work areas were respiratory protection is required until medical clearance has been provided.
  - The Medical Evaluation will be administered annually for those Workers required to wear respirators by their jurisdiction.
  - A Physician or Other Licensed Health Care Professional (PLHCP) will be used to perform medical evaluations.
  - The medical evaluation will be administered in a manner that ensures the Worker understands its content.
  - The Worker will be given an opportunity to discuss the questionnaire and examination results with the PLHCP, if requested.
  - A written recommendation regarding the Workers ability to use the respirator will be obtained from the PLHCP.
- Additional medical evaluations are required under certain circumstances such as:
  - Worker reports medical signs or symptoms related to ability to use respirator.
  - The PLHCP or Supervisor recommends re-evaluation.
  - Information from the respiratory procedure, including observations made during fit testing and procedure evaluation indicates a need.
  - Change occurs in workplace conditions that may substantially increase the physiological burden on a Worker.
- The following information must be provided to the PLHCP before the PLHCP makes a recommendation concerning a Workers ability to use a respirator:
  - Type and weight of the respirator to be used by the Worker.
  - Duration and frequency of respirator use (including use for rescue and escape).
  - Expected physical work effort.
  - Additional protective clothing and equipment to be worn.
  - Temperature and humidity extremes that may be encountered.
- Workers who pass the medical evaluation and wear tight fitting respirators will be fit tested prior to use.
  - Two types of fit testing, qualitative and quantitative, can be administrated dependent on the type of respirator to be used.

- Fit testing must be conducted annually or more frequently if a Workers facial or medical conditions change.
- Fit test records must be maintained for each Worker until the next fit test is administered.
- All compressed air used for breathing purposes shall be uncontaminated and shall meet, as a minimum, the standard of the ANSI/Compressed Gas Association (CGA), for Type I Grade D Breathable air.
- Contractor and rental compressors used to provide breathing air must meet these standards.
- Breathing air used from air compressors as a source must be filtered and must be monitored for carbon monoxide.
- Visually inspected and the following determinations made prior to its use by Workers:
  - Make certain the high temperature alarm is operational.
  - Determine the number of hours since the oil/air separator (if present) was last replaced and have the dealer replace prior to renting if unknown or if the operating hours exceed the manufacturer's instructions.
- The compressor oil and filter operating hours should be determined, and both changed prior to rental if unknown or if the operating hours exceed one-half (1/2) of the manufacturer's instruction.
- All rental equipment must appear to have been carefully maintained.
- Rented piston-type air compressors should never be used to supply breathing air to Workers.
- Breathing air from compressed gas cylinders must be Grade D and have a certificate of analysis indicating the gas contained in the cylinder meets ANSI/Compressed Gas Association Grade D standards.
- The certificate of air analysis for each cylinder shall remain at the worksite if the cylinders are in service and on location.
- In addition to the vendor certification, all compressed air cylinders must be checked for oxygen and moisture content prior to first use. The oxygen content must be between 19.5 and 23.5%. The moisture content in the cylinder must not exceed a dew point of -50 °F at 1 atmosphere of pressure.
- Cylinder valves and valve stems must have the protective caps in place when the cylinders are not in use.
- Cylinders should be secured in an upright position to prevent toppling and lessen the exposure to trip and fall hazards.
- Plant air shall not be used as a source of breathing air unless approved by the appropriate Company Representative and inline safety equipment has been installed which removes moisture, oil mists, particulates, organic vapors, and monitors for carbon monoxide.
- Workers required to utilize respiratory protection are properly trained.
- Apart from a trimmed mustache, Workers who may be required to wear a respirator must always be clean shaven.
- Respirators should be individually assigned whenever possible. Each individually assigned respirator shall be personally identified in a way that does not interfere with the respirator performance.

- Workers using full face respirators and requiring vision correction may use special spectacle kits, if needed. Contact lenses are not to be worn with respiratory equipment. Fit testing will be conducted with the spectacle kits in place.
- Individual and multiple people use respirators shall be cleaned and disinfected after each use.
- Proper cleaning and disinfecting of SCBA, abrasive blasting hoods or airline equipment should be performed according to manufacturer's recommended procedures only.
- If an air purifying respirator filter is to be used for more than one day the filter media shall be dated when installed and replaced as specified by the manufacturer.
- Single use disposable respirators and filter mask shall be disposed of by approved methods and not reused.
- Supplied air respirators and breathing equipment shall be inspected routinely, and.
  - Before each use.
  - At least monthly.
    - Following the manufacturer's recommended procedures.
- All respirator equipment shall be properly stored in a clean sealable bag, in a dust free area out of the sunlight and weather.
- It is recommended that respirators be stored without canisters or cartridges attached.
- All respirator equipment repairs are to be performed by Qualified Personnel or vendor.
- All non-disposable respirator equipment must be inspected monthly.
- Monitor respirator use to ensure that respirators are used in accordance with their specifications.
- Assist in the elimination of breathing hazards through engineering controls as the primary approach to Worker protection.
- Medical records for each Worker must be preserved and maintained for at least the duration of employment plus 30 years.

### **Air Purifying Respirators**

- Disposable air purifying respirators are individually assigned and are considered single use respirators.
- Single use dust respirators can be used in concentrations up to 5 times the exposure guideline (PEL, TLV, etc.) if the exposure guideline is greater than 0.05 mg/m<sup>3</sup>.
- Air purifying cartridges (i.e., vapor cartridges) are used on a single use basis and will be changed out prior to use during the next work shift.
- The appropriate cartridge, canister, or filter for protecting against the air contaminant shall be used.
- Air purifying respirators can be used for contaminants with poor warning properties if the contaminant concentrations have been measured and the filter media has been shown to remove the contaminant in a laboratory test.
- Half-face respirators can be used in concentrations up to 10 times the exposure guideline.
- Full-face respirators can be used in concentrations up to 50 times the exposure guideline.
- Full-face respirators shall be specified if the contaminant can irritate the eyes at the expected concentration.
- Workers using full face respirators that require vision correction will request and be provided special spectacle kits.

- Any Worker who voluntarily wears a respirator when one is not required (i.e., in certain maintenance and coating operations) is subject to the medical evaluation, cleaning, maintenance, and storage elements of this section, and will be provided with necessary training. Workers who voluntarily wear filtering face pieces (dust masks) are not subject to the medical evaluation, cleaning, storage, and maintenance provisions of this program.

### **Atmosphere-Supplying Respirators**

- Only Pressure Demand Regulators shall be used.
- When using in an IDLH or oxygen deficient atmosphere, a 5 minute (minimum) auxiliary escape cylinder and safety harness shall be used. (Five-minute escape packs are not considered an auxiliary air supply.)
- Standby personnel shall be available when someone else enters an IDLH or oxygen deficient atmosphere. The standby shall be in communication with the entry person and have reserve breathing equipment available.
  - All standby personnel will meet the approval and training requirements of this Specification.
- Abrasive blasting situations requires the use of an air supplied respirator equipped with a loose-fitting hood or helmet with a minimum air flow rate of 6 cfm.
- Waist belts for air supplied respirator systems shall be used so that the mask tailpiece is fastened to a ring or the belt.
- In IDLH or O<sub>2</sub> deficient atmospheres, persons using air supplied respirator systems shall be equipped with safety harnesses.
- For respiratory protection during the initial Atmospheric Monitoring of Open Systems in Hazardous / Restricted Areas and until work area has proven safe atmosphere:
  - The level and type of respiratory protection shall be based on the potential composition, volume, and pressure of the gas or vapor that may potentially be released during the break or opening.
  - When opening systems where a known potential for exposure exists, all Workers in the immediate work area shall wear the appropriate RPE, in accordance with the completed Hazard Assessment until a safe atmosphere has been verified.
  - If the composition and/or concentration of the contaminant is unknown or there is a potential for a Hazardous Atmosphere, assume the atmosphere is hazardous, perform exposure assessments and use RPE in accordance with the Respiratory Protection section of this manual.
  - If there is a potential for an atmosphere above 5 ppm of H<sub>2</sub>S (>5ppm H<sub>2</sub>S) or an oxygen level below 19.5% in the Worker's breathing zone during the job:
    - Workers must use supplied air (SCBA or SABA) as respiratory protection.
    - A Safety Watch out of range of a toxic atmosphere but within sight of the worker(s) must be used.
    - The Safety Watch must don SCBA or SABA but does not need to put on mask unless performing a rescue.

### **Contractors shall ensure that Workers:**

- Wear the proper respiratory protection when exposed to respiratory hazards.
- Inspect, maintain, and store the provided respiratory protection equipment.
- Conduct a quick positive/negative respirator pressure check prior to starting to work requiring a cartridge or canister type respirator.

### 5.39 Safe Handling of Pipeline Liquids

#### **Contractors shall ensure that:**

- Pipeline liquids are handled as a hazardous chemical.
- All Workers handling pipeline liquids are trained in the proper PPE use, proper sampling techniques and/or proper handling or disposal methods.

#### **Contractors shall ensure that Workers:**

- Handling liquids containing H<sub>2</sub>S, review the individual SDS for that material.
- Sampling or liquid transfers shall be handled following the established safety procedures for flammable liquids which include grounding, non-sparking tools/equipment, explosion proof equipment and no open flames.
- Wear the specific types of PPE identified from the Hazard Assessments for personal protection and respiratory protection recommended for the job specific task of sampling pipeline liquids.

## 5.40 Safeguards, Barricades and Warning Signs (Temporary)

### **Contractors shall ensure that:**

- Unprotected temporary openings in floors or elevated work platforms shall:
  - be covered with plywood that is at least 2 cm (¾-in) in thickness
  - have secured coverings capable of supporting twice the maximum intended load
  - only be removed to perform a particular task
- Coverings shall only be removed to perform a particular task. Coverings shall be replaced immediately after the task is complete or as appropriate during the task if other Workers are present near the work area.
- Suitable safeguards, flagging or barricades with warning signs or flashing lights shall be used to protect Workers from any work activity that may endanger them. Examples of such activities include sand blasting, open excavations, temporary openings in floors, construction, welding arc flash in pre-fab areas, pressure testing or overhead work.
- Prior to and during construction activities Contractor shall have hazard identification procedures used to systematically identify and mark all above ground facilities, equipment, piping, and pipeline components that are subject to vehicular or mobile equipment damage and provide adequate protection. The piping and equipment to be identified includes in-service piping, equipment, and facilities, as well as piping and equipment associated with the construction phase of a project. Protection shall be provided by maintaining a minimum clearance of at least three feet around all piping and equipment by utilizing barricades, barrier tape, cones, or fencing.
- Flagging shall be used as a warning to Workers of hazards that exist in work areas. Flagging tape shall be:
  - installed to completely encompass the work area containing the potential hazard, including access from levels above or below
  - prominently placed when conditions or activities may or do present a hazard to Workers or the public
  - placed to ensure Workers cannot enter the area where the hazard exists, without prior knowledge of the hazard
  - removed when the potential hazard no longer exists
- The following types of flagging shall be used:
  - RED – “Danger Do Not Enter” – Red with black lettering. This type of flagging is used where there is danger of an imminent hazard, such as falling objects. Only Workers involved in the work and aware of the hazards are allowed in these areas. All others must obtain prior permission from the flagging owner (i.e., Worker who installed the flagging).
  - YELLOW – “Caution” – Yellow with black lettering. This type of flagging provides a warning that a hazard exists in the area. Yellow flagging can be crossed by workers other than those who installed it, but awareness of the surrounding work areas is required.

- Instead of flagging and barricades a Safety Watch may be used to prevent Workers from entering the hazardous area, but only if the area is small enough to be easily managed and the Safety Watch remains in place until the hazard no longer exists.
- Warning signs identifying known hazards shall be posted to warn Workers and others in the area of the specific hazard. All signs shall be constructed in a professional manner and shall meet applicable legislation and engineering standards.
- Warning signs include, but are not limited to:
  - Directional Signs
    - Installed as required
  - No Trespassing/Open Ditch
- The signs shall be:
  - posted at all entries to the ROW
  - face the intersecting road/highway, where construction activities are being conducted
  - display a contact telephone number for unauthorized Workers to contact
- Construction Warning Signs
  - All crossings of any interstate, highway, municipal or private roads shall be posted with construction warning signs, which are designed and positioned in accordance with the requirements of the applicable legislation. Such signs shall be clearly visible to traffic, as appropriate to the crossing, e.g., visible from two or more directions.
- High Pressure Testing Signs
- Shall be posted:
  - at all entries to the ROW, public access points, while sections are under test
  - facing intersecting roads/highways
- Smoke Warning Signs
  - Warning signs shall be used to warn traffic of poor visibility due to smoke from brush burning operations. All such warning signs shall be in accordance with applicable legislation.
- Other warning signs shall be erected as required by applicable legislation or by Company to warn workers and/or the public of a range of potential hazards such as:
  - traffic hazards (e.g., stop, slow, curve, steep hill, noise hazards, caution, work crews ahead, suggested speed restrictions, trucks turning, work in/over navigable waters)
  - signs indicating venting in progress during any venting activities (like opening pig traps)
  - “Caution Open Hole” or similar when there is an opening
  - overhead hazards
  - respiratory hazards

- other PPE requirements (e.g., hard hat, hearing protection, eye protection required)

**Contractors shall ensure that Workers:**

- Periodically inspect barricades to ensure protection for Workers is adequate, and that barricades are still present and in good condition.
- Attach a flagging tag to all flagging tape. Multiple tags may be required depending on work area and hazards. The Worker installing the tape shall complete the tag with the following information:
  - name of the person who installed the flagging
  - phone number or radio channel for contact
  - date on which the flagging was installed
  - reason for the use of flagging



## 5.41 Scaffolding

### **Contractors shall ensure that:**

- Prohibit any Worker who has not received the required training to perform any of the tasks or activities related to scaffold erection, inspection, or dismantling.
- Load Capacity:
  - The scaffold and each of its components must be capable of supporting 4 times the maximum intended load.
    - Scaffolds must be designed by a Qualified Person and built and loaded according to that design.
    - Avoid excessive deflection of the scaffold platform by spreading the load out, if possible.
- A Competent Person oversees scaffold erection according to the manufacturer's specifications.
  - Knowledgeable about proper selection, care, and use of the fall protection equipment.
  - Evaluate connection points to support loads and prevent sway.
  - Assess hazards and exercise "stop work", if unsafe conditions are detected throughout the scaffold lifecycle.
  - Perform inspections for visible defects before each work shift and after any occurrence that could affect the structural integrity of the scaffold.
  - Provide direct supervision of the dismantling of scaffolds.
  - Comply with all applicable guidelines contained in this safety section.
  - Report damaged scaffolds, accessories, and missing or lost components.
  - Immediately report any unsafe act and condition to Contractor Management.
- Scaffold work practices and rules should be based on:
  - Sound design.
  - Selecting the right scaffold for the job.
  - Assigning personnel.
  - Fall protection.
  - Guidelines for proper erection.
  - Guidelines for use.
  - Guidelines for alteration and dismantling.
  - Inspections.
  - Scaffolds must be erected, moved, altered, or dismantled only under the direction of a Qualified Person, or as requested for corrective reasons by Company.
  - When scaffolding hazards exist that cannot be eliminated, then engineering practices, administrative practices, safe work practices, PPE, and proper training regarding Scaffolds will be implemented.
  - Duties performed on or around scaffolds shall be done by experienced and trained Workers.
- Do not erect, use, alter, dismantle, or move scaffolds close to energized power lines (see table below for minimum distances).

**Table 3: Minimum Scaffold Distances to Energized Power Lines**

LINE VOLTAGES	MINIMUM DISTANCES
Less than 50 kV	10 ft.
50 kV or greater	10 ft. + 4 in. for each 10kV over 50 kV

- Do not erect, use, dismantle, alter, or move scaffolds such that the scaffold or any conductive material handled while on the scaffold comes closer than 3 m (10 ft.) (lines under 50 kV) and 3 m plus 10 cm (10 ft. plus 4 in) for every 10 kV over 50 kV (lines over 50 kV).
  - If a safe distance from energized power lines cannot be maintained, call the utility company to have the source de-energized or relocated.
  - If a safe distance from energized power lines cannot be maintained, call the utility company to have the source de-energized or relocated.
  - Tag lines shall be used to hoist materials to prevent contact.
  - If electrical arc welding or other similar jobs are performed on a scaffold, the scaffold must be insulated and/or grounded.
- Do not block access to equipment, doors, and pathways used for emergencies.
  - Determine the type of pedestrian, vehicle, or equipment traffic that will be in the area.
  - The footing or anchorage for scaffolds must be sound, rigid, and capable of carrying the maximum intended load without settling or moving.
  - Objects such as barrels, boxes, loose brick, or concrete blocks must not be used to support scaffolds or planks.
  - Scaffolding more than 3 m (10 ft.) above the ground or floor must have guardrails and toe boards installed at all open sides and ends, excepting needle beam scaffolds and floats.
    - Guardrails must be made of not less than 5 x 10 cm (2 x 4-in) lumber (or other material providing equal protection) and must not be less than approximately 91 cm (36 in) or more than approximately 107 cm (42 in) high.
    - Guardrails must have a midrail of at least 2.5 x 15.2 cm (1 x 6-in) lumber or other material giving equal protection.
    - Supports must be at intervals not to exceed 2.4 m (8 ft.).
  - Scaffolds 1.2 to 3 m (4 to 10 ft.) high and having a minimum horizontal dimension in either direction of less than 45" must have standard guardrails installed on all open sides and ends of the platform.
  - Personal Fall Arrest Systems (PFAS) must be used when guardrails are not feasible, or while working on suspended scaffolds.
  - Overhead protection must be provided for Workers on a scaffold exposed to overhead hazards.
  - Where tools, materials, equipment, etc., are intended to be stacked higher than the toeboard, or where their falling could strike workers below, do one or more of the following:
    - Barricade the area with hazard warning tape, and do not permit unauthorized entry.
    - Install toeboards, screens, or canopies.
  - Toeboards must be a minimum of 10 cm (4 in) in height.

- o Toe boards and guardrails shall extend along the entire opening.
- Where persons are required to work or pass under a scaffold, a screen consisting of No. 18 gauge U.S. Standard wire 1.3 cm (½-in) mesh, or the equivalent, must be installed between the toe board and the guardrail covering the entire opening.
- Tubular welded frame scaffolding legs must be set on adjustable or plain bases and placed on mud sills or other foundations adequate to support the maximum rated load.
- Tubular welded frame scaffolding cross braces must be long enough to be automatically square and align vertical members.
- No welding, burning, riveting, or open flame work shall be performed on any staging suspended by means or fiber of synthetic rope.
- Only treated or protected fiber or synthetic ropes shall be used for or near any work involving the use of corrosive substances or chemicals.
- Suspension ropes shall be protected from contact with heat sources (welding, cutting, etc.) and from acids or other corrosive substances.

**Construction of Supported Scaffolds**

- Supported scaffolds have one or more platforms that are supported by beams, brackets, poles, legs, uprights, posts, frames, or similar rigid support. All load-carrying timber members of scaffold framing shall be a minimum of 1,500 fiber (Stress Grade) construction grade lumber.
- Wire, synthetic, or fiber rope used for scaffold suspension shall be able to support at least 6 times the intended load.
- All planking must be Scaffold Grades, or equivalent, as recognized by approved grading rules for the species of wood used. The maximum permissible span for 5 x 23 cm (2 x 9-in) or wider planks is shown in the table below.

**Table 4: Scaffold Planking Material Requirements**

	FULL THICKNESS UNDRESSED LUMBER			NOMINAL THICKNESS LUMBER	
Working Load (psf)	25	50	75	25	50
Permissible Span (ft.)	10	8	6	8	9

- The maximum permissible span for 3.2 x 23 cm (1¼ x 9-in), or wider, plank of full thickness shall be 1.2 m (4 ft.) with medium duty loading of 50 psi.
- When erecting scaffolds, make sure the first unit of any scaffold is plumb, aligned, and level.
- Plank the platform as tightly as possible with no spaces for materials or equipment to fall through. If full planking is not possible, ensure no space is more than 2.5 cm (1 in) wide.
- The front edge (edge closest to the work) of the platform must not be more than 35.5 cm (14 in) from the face of the work unless guardrail systems are erected along the open edge and/or personal fall arrest systems are used.
- Overlap planking a minimum of 30.5 cm (12 in) and secure planks from movement.
- Scaffold plank must extend over their end supports not less than 15.2 cm (6 in).
- Each end of a platform 3 m (10 ft.) or less in length shall not extend over its support more than 30.5 cm (12 in).
- Platforms greater than 3 m (10 ft.) in length must not extend over its support more than 45.7 cm (18 in).

- Platforms and walkways must be at least 48 cm (19 in) wide, unless the configuration of the application area makes this impractical and guardrails or personal fall arrest systems are used.
- Each abutted end of a plank must rest on a separate support surface.
- When a platform changes direction (e.g., turn a corner), any platform that rests on a bearer at an angle other than a right angle (90 degrees) must be laid first. Other platform planks that rest at right angles and over the same bearer will be placed second.
- The top edge height of top rails must be installed between 96.5 cm (38 in) and 114.3 cm (45 in) above the platform.
- Scaffold poles, legs, posts, frames, and uprights shall bear on base plates, mud sills, or other firm foundations.
- Never use cinder blocks, bricks, gravel, loose fill, or other means for leveling uneven surfaces or providing a foundation for the base plate.
- The entire scaffold shall be tied to and securely braced against the building or structure at intervals not to exceed 9 m (30 ft.) horizontally and 8 m (26 ft.) vertically.
- Casters and wheel stems shall be pinned or otherwise secured in scaffold legs. Casters and wheels must be positively locked if in a stationary position.
- Tube and coupler scaffolds shall be tied to and securely braced against the building at intervals not to exceed 9 m (30 ft.) horizontally and 8 m (26 ft.) vertically.

### **Inspection of Scaffolds:**

- Scaffolding and components shall be inspected for visible defects by a Qualified Person before each work shift and after any occurrence that could affect the structural integrity of the scaffold.
  - This includes changing weather conditions and prolonged work interruptions.
  - Footing, planking, guardrails, toeboards, connections, welds, and ladders or other access means.
  - Planks and wooden components must be free of rot, splintering, splits, and painted surfaces that could hide defects.
  - All members or parts of steel components must be straight and free of bends, cracks, dents, and rust.
  - Do not mix scaffold components from different manufacturers unless they fit together without force or modification, and the scaffold's structural integrity is maintained.
  - Do not use scaffold components made of dissimilar metals, unless approved by a Qualified Person.
  - Any defective components must not be used.
  - Immediately repair or replace damaged scaffolds or scaffold accessories.
  - Do not straighten or reuse defective parts.
  - Document inspections on scaffold inspection tag or other documentation method.

### **Dismantling Scaffolds**

- Scaffolds must be dismantled under the direct supervision of a Qualified Person.
- Seat planks correctly to prevent falling when other pieces of the deck are removed.
- When a scaffold must be left partially disassembled, place barricade tape at each point of access.
- Lower all components to the ground by rope, hoist, or hand-hand.

**Contractors shall ensure that Workers:**

- Always use a ladder or other proper means of accessing scaffolds. An access ladder or equivalent safe access must be provided.
- Never work on exterior scaffolds during severe weather/ thunderstorms.
- Never use a ladder, box, or other object to elevate your height while on scaffolds.
- Always keep three points of contact when climbing a ladder.
- Never work on a scaffold that is covered with ice or other slippery material, discontinue working on the scaffold until the hazard is alleviated.
- Keep all walkways and working surfaces clear of tools and debris.
- Never jump from one platform to another.
- Do not use cross braces to climb onto the scaffold or another level of the scaffold.
- Always place materials and tools away from the platform's edge.
- Practice good housekeeping.
- When moving manually propelled mobile scaffolds:
  - Stabilize the tower during movement.
  - Apply force as close to the base as practical, but not more than 1.5 m (5 ft.) above the supporting surface.
  - Move the scaffold on level floors and avoid areas with obstructions and openings.
  - Do not ride on mobile supported scaffolds unless the following conditions exist:
    - The floor or surface is level and free of pits, holes, or obstructions.
    - The height-to-base ratio does not exceed 2 to 1 (height is twice as long as the base is long/wide).
    - All tools and materials are secured or removed before scaffold is moved.
    - Workers are not on any part of the scaffold which extends outward beyond the wheels, casters, or other supports.

## 5.42 Severe Weather

### **Contractors shall ensure that:**

- If potential or imminent severe weather is forecast, the Hazards due to severe weather need to be identified and controls implemented.
- Severe weather considerations include:
  - **Lightning:**
    - If lightning is visible or thunder is heard, initiate shut down of all outside work activities and seek shelter.
      - Outside work shall not recommence until 30 minutes after the final observation of lightning or thunder.
    - If lightning is visible or thunder is heard, the following indoor work shall be stopped:
      - all testing or grounding for mitigating induced voltage.
      - work in or around structures (e.g., tanks, side-booms, cranes, dozers, etc.)
    - Where practicable, use lightning detectors to supplement visual and auditory detection of electrical storms; use the detector's specifications to determine detection ranges and action plans. For Clarity, the use of lightning detector does not excuse Contractor's obligations as set forth immediately above.
  - **Heavy Rain:**
    - Avoid driving on flooded access roads or ROWs
    - Avoid crossing bridges if water level is high and fast flowing
    - Stay out of trenches, excavations and below ground level unsheltered entry points
  - **Heavy Snow and Ice:**
    - To prevent slips, trips and falls, clear snow and ice from walking surfaces as quickly as possible after a winter storm. When walking on snow or ice is unavoidable, workers should be trained to:
      - Wear footwear that has good traction and insulation (e.g. insulated and water resistant boots or rubber over-shoes with good rubber treads),
      - Use traction aids where their use does not present additional hazards (e.g., hazardous locations), and
      - Take short steps and walk at a slower pace to react quickly to changes in traction.
  - **Hail/Freezing Rain:**
    - Take cover during hailstorms
    - Expect slippery walking and driving conditions
    - Be aware of possible damage to trees and power lines due to ice buildup
    - Avoid travel in these conditions
  - **Extreme Heat/Heat Stress:**
    - Consult the climatic condition reports from your local weather service during Hazard Assessment

o **High Wind:**

- When wind conditions exceed 50 km/hr. (30 mph), the Hazard Assessment shall be reviewed and adjusted to take the wind conditions into consideration, or the activity shall be suspended until wind conditions are more favorable
- Consider other Hazards such as dust and debris, secure any loose materials

o **Working after Sunset and before Sunrise:**

- Work after dusk shall not be permitted unless the following conditions are met:
  - Prior approval shall be obtained from the Company Representative,
  - There is a minimum of two (2) workers, or communications exist to outside areas to request assistance if required,
  - Adequate lighting is provided to illuminate the work, and
  - Regular “night shift” work shall require prior project approval.
- Night security Workers shall:
  - Not work alone, unless they have an adequate communication plan in place to contact other workers or emergency assistance as needed, and
  - Maintain communications and check in at least every two hours with Supervisor(s) familiar with the Worksite and the Emergency Response Plan for that project.

## 5.43 Transportation of Hazardous Materials (US ONLY)

### Contractors shall ensure that:

- Provide appropriate material to properly mark/label, package and ship hazardous material in accordance to the requirements of this section.
- Contractor vehicles which contain hazardous materials must be attended by the driver. A vehicle is attended when the driver is within 30.5 m (100 ft.) of the vehicle and has an unobstructed view.
- Contractor vehicles carrying hazardous materials must be parked 1.5 m (5 ft.) off the traveled portion of a public street or highway except for brief periods when the necessities of operation require the vehicle to be parked and it is impractical to park elsewhere.
- Identification, placement, and placarding requirements are dependent on the hazardous material being transported and the quantity of material being transported.

### Shipper and Carrier Responsibilities

- The DOT places specific responsibilities on the “shipper” and the “carrier” of hazardous materials.
- Avoid overnight shipments of hazardous materials by third party carriers. Shipments by these carriers may also require specific training prior to shipment.
- Shipper responsibilities include assurance of proper:
  - Labeling.
  - Marking.
  - Placarding.
  - Packaging of hazardous materials offered for shipment.
  - Shipping papers.
- Carrier responsibilities include the assurance of adequacy of:
  - Shipping papers.
  - Vehicle marking.
  - Placarding.
  - Safe loading and unloading of hazardous materials being shipped.

### Hazardous Materials Identification

- Proper identification, packaging, labeling, marking, and shipping papers shall be met for each hazardous material.
- These requirements will vary depending on mode of transportation and carrier.
- Communication of the hazards associated with the transportation of hazardous materials is required. This communication may be accomplished using:
  - Shipping papers.
  - Markings (includes information on packaging).
  - Labeling.
  - Placarding.
- The following are exempt from shipping paper requirement:
  - Materials of Trade.



- o Limited Quantities – which includes hazardous material.
- Not over 66 lbs. (30 kg) for solids or 8 gal (30.3 L) for liquids in Packaging Group II, III, or ORM-D materials. This includes the following materials:
  - o Gasoline, paints, paint related materials, hexanes, pipeline liquids, methanol, diesel fuel, kerosene, batteries fluid, flammable liquid n.o.s., and environmentally hazardous substances, solid, n.o.s.
- Division 2.1 or 2.2 that do not exceed 165 lbs. (75 kg). These would include the following materials: acetylene, flammable and non-flammable aerosols, compressed air, compressed gases, helium, hydrogen, methane, nitrogen, oxygen, and propane.
- Total gross weight of all hazardous materials used as materials of trade must not exceed 440 lbs. (200 kg) to use the exemption.
- Shipping papers are not necessary when transporting products only on lease roads within a field.
- The shipper is responsible for completing a Hazardous Material Shipping Paper form for any hazardous material or dangerous goods carried on vehicles unless exempted as “materials of trade”.
- Shipping papers include as applicable, hazardous materials manifest and a shipper’s certification. The papers must contain the following minimum information:
  - o Proper shipping name.
  - o Hazard class or division.
  - o Identification number.
  - o Packing group.
  - o Reportable quantity.
  - o Total Quantity (i.e. weight, volume, number, etc.).
  - o Certification (includes signature).
  - o A 24-hour emergency response number.
- Use the Hazardous Materials Table, 49 CFR Part 172.101 in the Hazardous Materials Compliance Pocketbook to properly identify and classify the material.
- A carrier may not transport a hazardous material unless it is accompanied by shipping papers.
- When transporting hazardous materials, the shipping papers should be kept in an envelope marked or stamped, “Hazardous Material Papers.”
- The hazardous material shipping paper(s) must be located within one of three places inside the vehicle.
  - o Driver’s door pouch with other material transfer or shipping reports.
  - o Clear view and within easy reach of the driver while seat-belted in the seat.
  - o On the driver’s seat if the driver leaves the vehicle.
- In addition to the shipping paper requirement, containers of hazardous materials must be marked.
  - o Marking consists of the proper shipping name and identification number (preceded by UN or NA, as appropriate) of the hazardous material contained in a package.
  - o Marking should be durable, in English, and not obscured by other markings or labels.

- Markings are required for containers with a capacity of less than 118.9 gal (450 L) or 1000 lbs. (454 kg).
- Containers such as drums that are used to transport smaller quantities of hazardous materials on public roads must be properly labeled.
  - Labels are color-coded and allow for quick recognition of a hazard. There are specific labels that must be placed on each container generally corresponding to the hazard class or division of the hazardous material.
  - The DOT specifies the design (a square) and size (4"x4") of each label, and these labels may only be used.
  - Labels are required for containers with a capacity of less than 118.9 gal (450 L) or 1000 lbs. (454 kg).
- Placards correspond very closely with the shape, color, and design of labels; and they are required for shipments of hazardous materials over 118.9 gal (450 L) or 1,000 lbs. (454 kg).
  - Some extremely hazardous materials require placards when they are shipped even in very small quantities, but these types of materials are not generally used by the Company. Placards alert persons to the potential dangers associated with the larger quantities of hazardous material(s) and serve to guide emergency personnel in their actions.
  - Placards include the proper name of the material, United Nations (UN) number and hazard class.
  - Placards should be placed on all four sides (required on at least two sides) of a motor vehicle, rail car, or freight container.
  - Placards must be correct and in place before the material is transported. It is the Shipper's responsibility to ensure placards are correct and in place.
  - Vehicles transporting a properly marked portable (not secured to vehicle) tank containing less than or equal to 118.9-gal (450 L) or 1,000 lbs. (454 kg) aggregate of hazardous materials do not have to be placarded.
  - Portable tanks must be marked with the proper shipping name of the contents on two opposing sides along with the hazardous materials identification number (UN 10 number) specified for that material.
    - If a cargo tank (i.e., a tank secured to the inside of the pickup's bed) containing more than 118.9 gal (450 L) or weighing more than 1,000 lbs. (454 kg) and containing hazardous materials is being transported, the vehicle must be placarded.
- Properly segregate the transported material to assure incompatible materials are kept apart by precautions such as separation by specific distances and/or raised off the floor and supported, etc. Some incompatible material cannot be carried on the same load under any circumstances.
- All loads must be loaded and equipped to prevent shifting during transportation.
- Any tank, barrel/drum, cylinder, or other packaging not permanently attached to a motor vehicle which contains any flammable liquid, compressed gas, corrosive material, poisonous material, or radioactive material must be secured against movement within the vehicle on which it is being transported.

- Compressed gas cylinders must be transported in one of the following ways to prevent them from overturning:
  - Securely lashed/chained in an upright position.
  - Loaded into racks securely attached to the motor vehicle.
  - Loaded in a case in a horizontal position and securely braced.
- Transport natural gas sample cylinders in DOT approved cases secured inside the vehicle with the shipping papers properly completed before vehicle movement.
- Smoking is NOT allowed when loading or unloading any explosive, flammable solid or flammable compressed gas.
- Regulated materials must be packed to prevent spillage, leaks, or escape of product into the environment.
  - Packaging is defined in two categories: non-bulk and bulk.
    - A non-bulk package means a single tank with a capacity of less than 118.9 gal (450 L) or a total weight of less than 1,000 lbs. (454 kg).
    - A bulk package means a single tank with a capacity greater than 118.9 gal (450 L) or a total weight greater than 1,000 lbs. (454 kg).
  - DOT approved packaging should be used for both non-bulk and bulk shipments of regulated hazardous materials to prevent breakage and/or spillage during transport.
- Prior to moving a motor vehicle for hazardous material transportation, verify it is good working order and check shipping papers, labeling, marking, and placarding (if required) for accuracy.
- A copy of the SDS for the hazardous materials being transported and/or a copy of the *Emergency Response Guidebook* should be inside each vehicle.
- Material of Trade is defined as a hazardous material (other than hazardous waste) that is carried on a motor vehicle for driver's safety, operation of the vehicle or direct support of the Contractor Company's principle business.
  - Material of Trade Exception is intended to allow the transportation of limited quantities of hazardous materials by motor vehicle to support the principle business without the need to comply with the Hazardous Materials Transportation regulations.
  - The aggregate weight of all hazardous materials classified, as a Material of Trade may not exceed 440 lbs. (200 kg) (gross weight including container and packaging) per vehicle.
- Flammable and Non-Flammable Gases such as natural gas sample cylinders, compressed nitrogen, oxygen and acetylene may be transported under the materials of trade exception, provided all three of the following conditions are met:
  - The gross weight does not exceed 220 lbs. (100 kg) for any single container.
  - The aggregate weight of all "Materials of Trade" transported does not exceed 440 lbs. (200 kg) gross weight total for the vehicle.
  - Materials of Trade are all packaged and secured for shipment according to the requirements set forth by this section.

- Workers may carry up to 12-cases of natural gas spot and/or CP sample cylinders without exceeding the 440-lbs (200-kg) Materials of Trade Exception quantity threshold.
- If more than the specified quantity is transported, the Materials of Trade Exception does not apply, and shipping papers are required.
- Transportation of nitrogen or other cylinders decreases the quantity of sample cylinder cases that may be transported without exceeding the 440-lbs (200-kg) Materials of Trade Exception threshold.
- Up to 8 gal (30.3 L) of gasoline, methanol or antifreeze may be transported under the Materials of Trade Exception.
  - Multiple 8-gal (30.3 L) containers may also be transported provided the total quantity does not exceed 440 lbs. (200 kg) (weight of contents plus containers) per vehicle.
  - If more than the specified quantity is transported, the Materials of Trade Exception does not apply, and shipping papers are required.
  - The transportation of gasoline must be in an OSHA-approved metal container as prescribed in the *Flammable and Combustible Materials* section.

**Contractors shall ensure that Workers:**

- Mark/label, package and ship hazardous material in accordance to the requirements of this section.
- Unless there is no practical alternative route, the operator of a vehicle containing hazardous materials must operate the vehicle over routes which do not go through or near heavily populated areas, places where crowds are assembled, tunnels, narrow streets, or alleys.
- No person may smoke or carry a lighted cigarette, cigar or pipe on or within 7.6 m (25 ft.) of a motor vehicle containing explosives, flammable or oxidizing materials or a vehicle that has an empty tank which has been used to transport flammable liquids or gasses.
- When fueling a vehicle containing hazardous materials, the engine of the vehicle must not be operating and the person in control of the fueling process must be at the point where the fuel tank is filled.
- A Class C – Commercial Driver’s License with Hazardous Material endorsement is required for any Worker involved in the operation of a vehicle that is placarded and transporting a single tank with a capacity greater than 118.9 gal (450 L) or 1,000 lbs. (454 kg) of a hazardous material.
- A normal Class D license will suffice when transporting smaller quantities.

## 5.44 Vehicle Safety

### **Contractors shall ensure that:**

The following regulations apply:

- In the USA, DOT, Federal Motor Carrier Safety Administration (FMCSA).

### **Commercial Motor Vehicles**

- Commercial Motor Vehicle (CMV) – A motor vehicle or combination of motor vehicles used in commerce to transport passengers or property if one or more of the following applies to the motor vehicle:
- In the USA, a vehicle with a gross vehicle weight ratings (or more, whichever is greater) of 10,001 lbs. (4,536 kg); or is designed or used to transport more than 8 passengers (including the driver) for compensation; or is designed to transport 16 or more passengers, including the driver; or is of any size and is used in the transportation of hazardous materials as defined in this section.
- Commercial Motor Vehicle drivers not requiring a CDL (Non-CDL) may operate vehicles that meet the definition of a commercial motor vehicle except for transporting a placardable quantity of hazardous materials.
- CMV drivers shall have a single, valid Commercial Driver's License (CDL) to drive Contractor CMVs that:
  - have a gross combination weight or gross vehicle weight of 26,001 lbs. (11,794 kg) or more; or
  - is designed to transport 16 or more passengers, including the driver; or
  - are of any size and used to transport hazardous materials requiring a placard.
- Vehicles identified as commercial motor vehicles shall ensure the following are readily accessible in the event of an accident or inspection:
  - Shipping papers for transporting hazardous materials, if applicable.
  - Driver's license with the proper class and endorsements for the vehicle being operated
- Copy of the completed Driver's Vehicle Inspection Report (post-trip inspection report) if equipment problems or safety concerns were identified.
  - In the US,
  - Medical certificate certifying current medical exam
  - Daily Driver's Log
- Backup alarms will be installed on all heavy equipment and utility trucks.
- A substantial cable guard should protect the operator of winch trucks or winch tractors from the danger of flying lines.
- At a minimum, carry the following equipment in all Contractor-owned and long-term (over 6 months) leased/rented vehicles:
  - Spare tire
  - First aid kit
  - Flashlight

- Jack
- Fire extinguisher
- Triangle reflectors and/or battery-operated flares
- 18" Red Warning Flags for oversized commercial loads
- Spare bulbs and/or fuses
- Vehicle-mounted fire extinguishers must be:
  - Secured to the vehicle with a heavy-duty bracket designed specifically for the extinguisher by the extinguisher manufacturer
  - Mounted for quick and easy access
  - Mounted in a location that will help reduce the possibility of back and muscle strain when removing the fire extinguisher from the vehicle
  - In the US, Size 10-30 lbs. type BC or ABC extinguisher
- All Non-DOT Contractor and long-term leased/rented vehicles will be inspected at least monthly, document deficiencies.
  - Keep documented Vehicle Inspection Reports filed for one year.
- Inspect, repair and maintain trailers in accordance with the applicable *Federal Motor Carrier Safety Administration (FMCSA) Regulations*.
  - Visually inspect trailers and vehicle hitches before each trip looking for worn, bent, cracked, broken or missing parts.
- Inspection Record Keeping for Commercial Motor Vehicles
  - DOT Vehicle Inspection Report (and Post Trip Inspection).
  - Document visual inspections of trailers and hitches on the DOT – Driver's Vehicle Inspection Report.
  - Keep the Vehicle Inspection Reports filed onsite for one year.
  - Visually inspect vehicle prior to operating.
  - Document any deficiencies detected.
- Annual Vehicle Inspection Report
  - All DOT vehicles including power units and trailers.
  - A copy of documentation shall be carried in the power unit/trailer and may include a sticker or decal. (Varies by state/province.)
  - In the US, Maintenance Logs (Offshore only)
    - Records of these inspections must be retained for 14 months from the report date.
    - Ensure Maintenance Logs are maintained for all commercial vehicles.
    - Attach a copy of the maintenance and repair receipts to the maintenance log.
    - Vehicle repair information should also be retained for one year.
- The minimum requirements for vehicle recovery straps (if available).
  - Recovery Strap Specifications:

- Recovery straps/ropes must meet the following minimum criteria:
  - Nylon strap/rope with manufactured ends such as Cordura eyes (sewn loops) suitable for use with a clevis,
  - Minimum two clevises per strap,
  - Minimum 6 m (20 ft.) length,
  - Ensure that the rated capacity of recovery strap is adequate for the weight of the vehicle being recovered.
- Prohibited:
  - Towing straps and chains are not designed for vehicle recovery and therefore must not be used for vehicle recovery operations.
  - Lifting slings are not designed for recovery and therefore must not be used for vehicle recovery operations.
- Identification:
  - Vehicle recovery straps/ropes must be marked with the rated strengths and/or capacities and be identified as VEHICLE RECOVERY STRAP.

### **Alcohol & Drugs Prohibited**

- Required Tests for commercial motor vehicle (CMV) operators who hold a commercial driver's license:
  - Pre-Placement Testing
  - Reasonable Cause
  - Post-Accident Testing

### **Contractors shall ensure that Workers:**

- Inspect the vehicle you are operating as necessary; vehicle must be maintained in safe operating condition. Only operate properly equipped and maintained vehicles.
- Verify that the necessary documents are in the vehicle (if driving a vehicle with a gross weight rating more than 26,000 lbs.).
- Verify that the vehicle is equipped with appropriate safety equipment.
- Possess a valid driver's license for each type of vehicle they operate and have the correct license in their possession when operating a vehicle.
- Maintain a good driving record and submit driver's abstracts when required.
- Retain each vehicle's current registration and insurance information in the cab of each vehicle.
- Immediately report all Motor Vehicle Incidents (MVI), driver's license violations and suspensions to their Supervisor.
- All drivers must perform a complete 360° check before moving a parked vehicle. This applies to all Contractor vehicles and rental vehicles.
- When parking in a facility, in a location not designated for parking, the following precautions should be taken:
  - Note proximity to barriers, piping, equipment, vents, etc.
  - Is the vehicle parked in a Hazardous Area and need to complete a Safe Work Permit?
  - FIRST MOVE IS FORWARD
  - Set the parking brake

- Set wheel chocks if available
  - Before entering the vehicle to leave, perform a 360° check, noting again, the location of piping and equipment
- Obey all traffic signals and posted speed limits.
- Drive slowly and with caution, as appropriate, e.g., when road or driving conditions are poor or hazardous, and/or when Workers or other people are present.
- Properly use all the safety mechanisms installed on vehicles, including seat belts.
- Ensure that all vehicle occupants are always wearing their seat belts when the vehicle is in motion.
- Use a Spotter in the following situations:
  - When backing into a busy roadway
  - When backing a pickup, utility truck or heavy equipment in a facility
  - When the heavy equipment operator cannot clearly see the work
  - When the heavy equipment operator is moving and cannot see all parts of the machine and its path of travel
- Driver and Spotter to communicate using hand signals that are agreed upon and understood prior to moving the vehicle.
- Any time a parked vehicle is left unattended, the motor should be shut off and the parking brake set.
  - Following are some exceptions when the motor of a parked, unattended vehicle can be left running:
    - When using exhaust to warm or thaw equipment
    - When using jumper cables to start or power equipment
    - When using auxiliary equipment such as an air compressor, auto crane, etc.
    - When the motor of a parked, unattended vehicle is left running:
      - Set the parking brake
      - Set wheel chocks
- To ensure a trailer will not break away from the towing vehicle:
  - Ensure correct hitch ball size and compatibility with receiver
  - Use adequately sized tow chains
  - Securely fasten tow chains
  - Cross tow chains to prevent a hitch from contacting the ground if it becomes disconnected
- Check Heavy Equipment vehicles at the beginning of each shift to ensure that the equipment is in safe operating condition.
  - Conduct a visual pre-start up inspection / walk-around.
  - Inspect all heavy equipment at regular intervals, depending on use, for:
    - Proper adjustment of operating mechanisms
    - Excessive wear or deterioration of components
    - Cleanliness of hydraulic system



- Accidental damage
  - Inspect truck bed and trailer bed loads and secure against movement before over-the-road operation.
  - Refer to the *Cargo Management Guide* for additional information on cargo securement.

## 5.45 Working Alone

### **Contractors shall ensure that:**

- A Working Alone policy is established for the project as applicable.
- Assessments made regarding the risk of working alone shall, at a minimum, consider the following before making the decision to begin or continue to work:
  - Hazard(s) involved with the work (including electrical, temperature extremes, hazardous atmosphere)
  - Isolation from immediate First Aid and Emergency Medical Services; (> 20 minutes)
  - Lack of or limited ability to call for help
  - Travelling alone
  - Meeting with stakeholder/landowner away from their office
  - Working in areas with known security problems; and/or
  - The effectiveness of existing safety measures.
- Workers may not work alone under hazardous conditions. The following conditions or activities are examples when working alone is prohibited:
  - In hazardous atmosphere (i.e., >5ppm H<sub>2</sub>S, ≥10% LEL; <18-23%< O<sub>2</sub>; above ACGIH thresholds)
  - Confined Space Entry
  - Pipeline Section Repair
  - Purging Pipelines or Tanks
  - Hot Work, (Category 1)
  - Hot Taps or Repairing Live Valves
  - Loading or pulling pipeline pigs
  - Critical or Serious Lifts
  - Working at heights requiring fall protection equipment
  - When travelling on an ATV or snowmobile
  - Entering a building after an intrusion alarm where it is apparent that an intruder may be present
  - Dealing with potentially violent landowners or co-workers; and
  - Confronting criminals (break and entry).
- Lone Workers must be checked on at a frequency which is dependent upon the job being performed. In no case should the frequency be less than once each work day.
- Working alone controls may include, but are not limited to:
  - “Man down” or lone worker alarm or pendant.
  - “Check-ins” with a designated contact person that:
    - are visual or two-way contacts (or, a one-way system may be acceptable if it allows the worker to call or signal for help and will send a call for help if the worker does not reset the device after a predetermined interval)
    - are of a frequency determined to be acceptable based, on a hazard assessment (factoring location and activities involved)

- activates the escalation strategy if contact cannot be made, or there are unusual delays in re-establishing contact
- Provision for emergency rescue and first aid personnel.
- Auto notification and location device (Satellite GPS Messenger) in the event of an emergency in a remote location where response is required.
- Effective means of communication include, but are not limited to:
  - portable or cell telephone
  - walkie-talkie
  - personal alarm or pager
  - periodic site visits
  - electronic methods, such as online web applications
  - check-in system and requirement for updating an individual's status while working alone
  - GPS-based communication device (e.g., SPOT Messenger) use of software or hardware to assist with communication in circumstances of poor network coverage
- A Worker would be considered missing if they fail to respond at the designated contact time and continuing attempts to contact them over the next fifteen (15) minutes have been unsuccessful.

**Contractors shall ensure that Workers:**

- Travelling alone to or through remote locations shall inform their supervisor or designate of their travel plans. Upon arrival at the destination the Worker shall make contact and provide an update.
- The supervisor or designate shall log all the information regarding the worker's travel plans and arrival time and status. It is the responsibility of the supervisor to initiate a response if communications have failed to be met.

## Walking and Working Surfaces

### **Contractors shall ensure that:**

- In the US, Contractors working at Company facilities and worksites within the US are required to comply with the 29 CFR 1926.501 and other applicable OSHA workplace safety regulations.
- Workers receive fall protection system training as applicable to their job duties.
- Fall protection system equipment is provided for worker use and is used by each Worker at all locations with fall hazards.
- All work areas have a means of access/egress (structure, stairs, ladders, scaffolding, etc.) that minimizes worker exposure to fall hazards.
- Walking-working surfaces are inspected, regularly and as necessary, and maintained in a safe condition.
- Immediately take measures to ensure walking/working surfaces that are not in a safe condition are barricaded, isolated and/or usage is prevented.
- Walking and working surfaces must have the strength and integrity to support Workers and shall be kept clean, dry (where possible), and orderly.
- Every floor, workplace, and passageway shall be kept free from protruding nails, splinters, holes, or loose boards.
- All floor and wall openings, including manholes, trapdoors, pits, ladder-way floor openings, and chute openings, must be safely covered or blocked from access.
  - Barricades that are designed to prevent someone from falling into the opening must be visually noticeable and cannot have additional openings that create additional fall hazards.
  - Floor surfaces surrounding the opening shall be free of clutter and slippery material.
  - When an opening is not covered or blocked from access, a person must be assigned for constant attendance to the opening until the cover is replaced.
- Floor Openings, Wall Openings and Holes
  - Every floor opening or platform shall be guarded by a standard railing.
  - Toe boards must be installed around floor openings of floor holes and wall openings and where the potential exists for tools and other materials to fall on personnel working below.
- The floor or roof of a building shall not be overloaded with materials and/or equipment over the approved load limits. Elevated storage and other platforms shall be marked with the load bearing weight.
- Guardrail Systems
  - Guardrail systems must be surfaced to prevent injury to a worker from punctures or lacerations, and to prevent snagging of clothing.
  - Where material is piled to such height that a standard toe board does not provide protection, paneling from floor to intermediate rail, or to top rail must be provided.
- Stairways, Exits, Landings and Openings shall be designated and kept clear of hazards, debris, snow and ice.
- Exposed duct banks and conduit shall not be used as walkways.

- Building exits shall be marked and shall have emergency lighting where required by Applicable Legislation.
- Other Working Surfaces – Dock boards (Bridge Plates)
  - Portable and powered dock boards must be of sufficient strength to carry the load imposed on them.
  - Portable dock boards must be secured in position by being anchored or equipped with devices that prevent slippage during use.
  - Handholds, or other effective means, shall be provided on portable dock boards to permit safe handling.

**Contractors shall ensure that Workers:**

- Inspect ladders and fall protection system equipment before using and remove any defective equipment from service. Immediately report damaged fall protection equipment, ladders, scaffolding, accessories, and missing or lost components to supervision.
- Use ladders, scaffolds and fall protection systems for their intended use and in a safe manner.
- Refuse to use fall protection systems for which training has not been received.
- Immediately report non-injury and injury falls to supervision and remove from service any fall protection equipment subjected to a fall.
- Immediately take measures to barricade, isolate, or prevent usage of walking/working surfaces that are not in a safe condition, and report condition to supervision.
- Fall protection equipment shall always be worn and used when working from an Elevating Work Platform (EWP).

## 6 Administrative Controls – Industrial Hygiene

### 6.1 General Requirements

Contractor is required to have a written Industrial Hygiene Program to protect Workers as applicable to all work to be performed, to include (but not limited to) the following:

- Asbestos Management
- Bloodborne Pathogens (**US only**)
- Hearing Loss Prevention
- Hydrogen Sulfide
- Lead Management
- Naturally Occurring Radioactive Material (NORM)
- Heat Stress or Cold Stress

### 6.2 Asbestos Management

#### Contractors shall ensure that:

- ACM and potential ACM must be identified and documented (i.e., signage, inventory) and managed in accordance with the applicable Company and legal requirements, as it pertains to Contractors work when ACM may be encountered during maintenance, repair, construction, demolition, and removal activities.
- All Workers who face a potential exposure to asbestos must receive training applicable to their potential level of exposure based on the tasks they are expected to perform.
- At minimum, Workers should have sufficient knowledge to identify asbestos exposure hazards that may exist in their work assignments and either know how to control these hazards or know who to contact to assist in controlling these hazards.
- Regulatory reporting (e.g., permits or notices) requirements for work involving asbestos handling or disposal must be completed as required.

### 6.3 Bloodborne Pathogens

#### Contractors shall ensure that:

- Identify the Workers with potential risk of occupational exposure to bloodborne pathogens.
- Use engineering controls and work practice controls to eliminate or minimize worker exposure to Bloodborne Pathogens in the workplace.
- Workers trained in First Aid/CPR shall be vaccinated for Hepatitis B or sign the *HSF-034 Hepatitis B Vaccine Declination* or equivalent.
  - Vaccinations are to be performed under the supervision of a licensed physician or other health care professional.
  - Cost for Hepatitis B Vaccination will be paid for by the Contractor.
  - The Worker can decline the vaccination for the following reasons:

- the Worker elects not to receive vaccination.
  - the Worker has previously received the complete Hepatitis B Vaccination series.
  - antibody testing has revealed the Worker is immune to the virus.
  - the vaccine is contraindicated for medical reasons.
- Workers who initially decline the vaccination can request the vaccination later if that Worker is covered by this section.
- The *Hepatitis B Vaccine Declination* form is completed and filed for Workers who decline taking the vaccination.
- Bloodborne pathogen kits are inspected monthly.
- Where the potential for exposure remains after an Incident, the following controls must be implemented, including the use of PPE:
  - Responders must analyze each potential medical situation and use good judgment to determine the necessary PPE for the situation.
  - Appropriate PPE must be worn by the Workers trained to administer first aid.
  - Measures should always be taken during medical response to minimize exposure to Workers and surrounding personnel.
  - Limit the number of persons attending to the injured person.
  - Keep spectators at a reasonable distance and enforce other control measures of this manner.
- Contractor shall provide hand washing facilities readily accessible to Workers who may be potentially exposed while providing first aid or medical assistance; if washing facilities are not provided, antiseptic cleansers shall be provided.
- Workers involved in providing first aid or medical assistance shall:
  - wear appropriate PPE, which includes eye and face protection, hand protection and protective clothing (i.e., coats, gowns or jackets).
  - wear disposable latex gloves when hand contact with blood, body fluids or bloodborne pathogens is anticipated.
  - discard gloves if they are cracked, peeling, torn or punctured, or when their ability to function as a barrier is compromised.
  - remove any PPE or other clothing that is penetrated by blood, body fluids or bloodborne pathogens; immediately, or as soon as reasonably practical.
  - Remove contaminated clothing soiled with blood or bodily fluids as soon as possible and washed before clothing is re-worn or properly disposed.
- The following list of PPE will meet all requirements under the section:
  - pair, latex exam-quality gloves.
  - eye and face shield with ear loop mask (for non-CPR-related care).
  - CPR barrier device (CPR-face piece).
  - germicidal wipes.
  - protective body clothing (disposable gown or Tyvek suit).
  - “universal” red biohazard disposal bags or plastic disposal bag and biohazard stickers with twist tie.
- Medical hygiene equipment will be provided and used after completion of medical care in which exposure could have occurred, including:

- gloves – a pair of surgical gloves shall be worn by each Worker.
  - mask, eye protection, and face shields – masks, in combination with eye protection devices such as goggles or safety glasses with solid side shields, will be worn wherever splashes, spray, spatter or droplets of blood or other potentially infectious materials may generate nose or mouth contamination.
  - gowns, aprons, and other protective body clothing – appropriate protective clothing such as, but not limited to, gowns, aprons, lab coats, clinic jackets, or similar outer garments shall be worn in certain occupational exposure situations.
  - CPR face piece – used when performing CPR.
  - antiseptic wipes – provided for use in cleaning hands if a hand washing facility is not readily available.
  - bio-hazard disposal bags – provided to dispose of any material that was contaminated with blood and cannot be decontaminated for reuse (i.e., gauze, bandages, CPR face pieces, masks and gloves, wipes or absorbing material used in cleanup, etc.). This can be the “universal” red biohazard disposal bag or plastic (garbage type) bag with the biohazard label.
- Project Locations shall have specific containers for safe disposal of sharps.
  - The following precautions shall be taken when handling sharps:
    - a sharps container shall have a clearly defined maximum capacity (i.e., have a fill line that indicates when the container is  $\frac{3}{4}$  full) and shall be sturdy enough to resist punctures under normal conditions of use and handling.
    - a person shall not re-cap a used needle.
    - each used needle shall be safely disposed of in a sharps container.
    - sharps containers shall be emptied when they become  $\frac{3}{4}$  full so that the containers can be disposed of properly.
  - All Contractor Locations shall post warning signs and label storage or collection containers, as required by procedures associated with this Section. Warning signs shall be fluorescent orange, with lettering and symbols of a contrasting color. Storage or collection containers shall be identifiable, e.g., red bags or other suitable, labeled containers.
  - Contaminated materials are to be placed in appropriately labeled designated leak-proof waste disposal bags for handling and disposal.
  - If outside contamination of a primary waste disposal bag occurs, that bag is to be placed within a second leak-proof disposal bag and appropriately labeled for handling disposal.
  - All contaminated material that cannot be decontaminated will be disposed of in the biohazard disposal bags. Typical items that would be decontaminated are work area surfaces, safety glasses, etc.
  - The disposal bag should be tightly sealed with masking or duct tape.
  - Contact should be made with your local waste disposal company for proper disposal of the waste as bio-hazardous regulated waste. Document the local waste disposal company accepting the waste, the date, contact information and invoice for the service.
  - Any medical recordkeeping will be maintained in the Contractor Medical Records. These records will remain a part of the Worker’s CONFIDENTIAL records.



**Contractors shall ensure that Workers:**

- Report any bloodborne pathogen exposures to supervision before the end of the shift or within 24 hrs.
- Any Worker who is potentially exposed to Bloodborne Pathogens while on the job shall immediately receive a confidential medical evaluation.
- Where a potential exposure to or contact with blood, body fluids or bloodborne pathogens has occurred, the Worker shall:
  - wash their hands with soap and water immediately, or as soon as reasonably practical, or wash their hands immediately after removing potentially contaminated gloves or any other potentially contaminated PPE.
  - wash any area of the body as soon as possible after exposure or contact.
  - flush mucous membranes with water, as soon as possible after exposure or contact.
- Additional preventive measures shall include:
  - equipment or surfaces that may be contaminated by blood, body fluids or bloodborne pathogens shall be decontaminated using appropriate disinfectant, preferably by the Worker involved, if able to perform this task (e.g., a Worker is cut, but able to apply their own bandage and wash the affected surfaces).
  - if a Worker is unable to wash a contaminated surface or area, then another trained Worker shall carry out the decontamination, using PPE and appropriate disinfectant, in accordance with procedures.
  - all contaminated or potentially contaminated material (including PPE) shall be placed by the involved Worker(s) in a designated receptacle for collection and disposal, prior to leaving the work area.
- Wash their hands after removing their protective gloves and or clothing with soap and water following any contact with blood or bloodborne pathogens.
- Antiseptic wipes should be used if a hand washing facility is not readily available.
- Eating, drinking, smoking, applying cosmetics or lip balm and handling contact lenses is prohibited in situations where there is potential for exposure to bloodborne pathogens.
- Workers performing cleanup and equipment decontamination must wear PPE. PPE should be the last items removed and discarded in the disposal bag.

## 6.4 Hearing Loss Prevention

In US, hearing protection measures and hearing loss prevention programs are mandated by OHS / OSHA regulators.

### **Contractors shall ensure that:**

- A Hearing Loss Prevention program is implemented if they have a potential noise hazard that exceed the following regulated thresholds:
  - **Within the US**, this includes any facility or operation where worker noise exposures reach or exceed an 8-hour TWA of 85 decibels (dBA).
- Management must ensure sound level surveys are performed to identify work areas and job descriptions that must be subject to the Contractors Hearing Loss Prevention program.
- Workers that meet these thresholds and have job descriptions that expose them to these noise levels must participate in audiometric testing (hearing test) requirements in the Contractors Hearing Loss Prevention programs.
  - Audiometric testing results are recorded and linked to long term monitoring programs including programs that track and record suspected industrial hearing loss in individual Workers.
- Contractor must provide the following control measures to reduce Worker noise exposure to within regulated limits:
  - Engineering controls such as:
    - modification or maintenance of equipment to reduce generated noise levels.
    - enclosure of noise generating equipment.
  - Administrative controls such as:
    - Alterations in work scheduling to reduce worker exposure to excessive noise levels.
    - Signage to mark areas with high noise levels and required hearing protection PPE if working under noise in these areas.
    - Training and education on noise hazards and the proper use and maintenance of hearing protection devices.
  - Supplying and enforcing the use of personal hearing protection include earplugs and earmuffs (or both).

### **Contractors shall ensure that Workers:**

- Wear properly fitted hearing protectors per the manufacturer's recommendations, in all posted high noise areas at the time of exposure and around tasks that produce noise.
- Store and maintain hearing protectors in a clean, dry (sanitary) environment.
- Report noise hazards and hearing protector problems to their Supervisor.
- Participate in audiometric testing and hearing loss monitoring programs as required.

## 6.5 Hydrogen Sulfide

### **Contractors shall ensure that:**

- Contractors H2S program is designed to ensure full compliance with federal regulation in both the United States (OSHA).
- The H2S program requirements are applicable to those Company areas and facilities that present a risk of H2S exposure above the ACGIH limits (i.e., the facility or operating area must process, store, or transport a gas or liquid product that could produce with any type of loss of containment a Worker's breathing zone exposure to a TLV-TWA above 1 ppm; or a TLV-STEL averaged over 15 minutes above 5 ppm not more than four times per day with at least 60 minutes between successive exposures).
- Basic information on H2S exposure hazards needs to be readily available and regularly reviewed (e.g., annually or prior to operation with H2S exposure risk) with Workers on any sites subject to an H2S Program, including:
  - Properties, symptoms, and consequences of H2S exposure.
- Mandated Asset Area or local procedures, including personal gas monitor requirements that are critical preventing H2S exposure risk are communicated.
- Emergency response procedures, including the importance of knowing wind direction, muster points, and rescue requirements are communicated.
- Visitors to sites with H2S exposure hazards must be informed of the hazard, basic emergency response, and escorted in areas with H2S exposure hazard by an authorized person unless an Employee or Contractor already familiar with H2S related procedures and local H2S hazards.

### **Contractors shall ensure that Workers:**

- Remain aware of where and how they may encounter H2S exposure risk within the operating area or facility in which they are working.
- Know and follow any procedures designed to manage H2S exposure risk.
- Know and follow pre-determined emergency response procedures for H2S release incidents.

## 6.6 Lead Management

### **Contractors shall ensure that:**

- Contractors Lead Management Program ensures full compliance with federal regulation in both the United States (OSHA).
- Contractor has verified which areas or facilities associated with the project have lead containing paints and coatings on structures or equipment.
- Know (or review when applicable) the Contractors Lead Management Program elements, procedures, and practices that must be followed during any activities that may disturb lead containing (or possibly lead containing) paints or coatings.
- Contractor supervisor must ensure they are sufficiently aware of paints and coatings that contain lead or may contain lead to ensure Lead Management Program requirements are met if work activities will involve disturbing these lead-containing paints or coatings.
  - Workers regularly working in areas with lead-based paints or coatings should be informed of this hazard.
- All Workers should be made aware of lead hazards if their work will involve potentially disturbing or working around activities that are disturbing lead paints or coatings.
  - This may be managed through a variety of communication channels including general training on hazardous substances and in pre-job hazard assessment and control activities.
- Any activity that may involve disturbing, removing, disposing, or otherwise handling paint or coatings that contain lead needs to be conducted in accordance with the applicable Lead Management Program.
  - Different types of activities create higher or lower levels of risk and control measures are mandated based on the type of activity and the potential exposure to lead that could come from that activity.

### **Contractors shall ensure that Workers:**

- Complete and maintain applicable lead hazard awareness or management training as mandated, based on site exposure risks and job description.
- Report any potential lead exposure risks, known lead exposure risks, or any known lead exposure immediately to their Supervisor.
- Know and follow any procedures designed to minimize exposure to lead, including as required area isolation, signage, and/or ventilation, respiratory protection, and other PPE requirements.

## 6.7 Naturally Occurring Radioactive Material (NORM)

### **Contractors shall ensure that:**

- Contractor NORM Program ensures full compliance with the US NORM Program (where applicable) exist to ensure activities related to the detection, control, decontamination, and/or disposal of materials or equipment contaminated at Company sites/facilities are conducted as required and personnel conducting these activities do so safely.
- NORMs management practices will vary between jurisdiction based on local requirements. All programs, however, will provide the following elements:
  - identifying equipment and areas that carry a risk of NORM exposure (based on a NORM survey).
  - signage for any equipment found to exceed regulatory radiation limits.
  - PPE and personal hygiene practices required if there is potential of handling NORMs contaminated material or equipment.
  - training requirements (at various levels depending on role in NORM program).
  - storage and disposal requirements for NORMs and NORMs containing or contaminated equipment.

**Contractors shall ensure that Workers:**

- Complete and maintain applicable NORMs training as mandated, based on site exposure risks and job description.
- Know and follow any procedures designed to minimize exposure to NORMs and reduce overall NORMs exposure when conducting activities with a NORMs exposure risk.

## 6.8 Heat Stress or Cold Stress

### Contractors shall ensure that:

- Preventative measures are implemented when extreme weather conditions are anticipated.
- Routinely assess the risks associated for personnel working in cold or hot climates.
- Adequate work schedules are developed to allow for modified rest periods during the extreme weather.
- Re-allocate or rotate staff duties to reduce individual worker exposure to extreme heat or cold conditions.
- Workload and work activities are arranged to better fit the climate exposures.
- Schedule hot jobs to cooler times of the day and cold jobs to warmer times of the day, if possible.
- That water and/or replacement liquids are available to prevent dehydration during extreme thermal weather conditions.
- Reduce the physical demands of work tasks with mechanical devices (e.g., use hoists, lift-tables, etc.).
- Provide climate conditioned rest areas for cold and heat extremes, such as radiant heaters to warm Workers or air conditioning to cool them.
- In areas where heat stress is likely, Contractors shall have a heat stress plan to protect workers.
- Reduce the temperature and humidity through air cooling.
- Increase air movement by providing fans for spot cooling.
- Use insulating and reflective barriers to control heat as practical.
- Extreme Heat Guidelines
  - Assess the demands of all jobs, have monitoring, and control strategies in place for hot days.
  - Obtain the Humidex values by measuring temperature (dry bulb) and relative humidity and factoring them into the Humidex table.
  - Obtaining heat index from a reliable weather service forecast may also be used as a point of reference.
  - Determine the amount of cloud cover, the exertion level of the work being conducted, and the type of clothing being worn to calculate the correction factor.
  - Apply the correction factor.
  - Repeat the Hazard Assessment process whenever climatic conditions change more than +/- 5 °F or ~+/-3 °C
  - Additional controls to be applied:
    - reduce the physical demands of work (e.g., excessive lifting, digging with heavy objects).
    - provide recovery areas (e.g., air-conditioned enclosures, rooms for rehydration).
    - use shifts (e.g., early morning, cool part of the day, night work).
    - use relief Workers.
    - use Worker pacing.

- take steps to protect Workers from exposure to UV radiation such as sunscreen, PPE, and clothing with UV protection and wide brims.
  - assign extra Workers and limit worker occupancy or the number of Workers present, especially in confined or Enclosed Spaces.
  - train Workers to recognize the signs and symptoms of heat stress; and to know and follow heat stress prevention measures.
  - provide water nearby on the Worksite (Workers should drink about one cup of water every 20 to 30 minutes, even if they are not thirsty).
  - consult the Occupational Hygienist for addition actions to consider.
- Extreme Cold Guidelines
    - Wear layers of warm clothing and cover as much exposed skin as possible.
    - Train Workers to recognize signs and symptoms of cold related conditions in other Workers.
    - Increase the frequency and length of rest breaks as needed.
  - Workers have adequate personal protection from thermal extremes including clothing and work location.
  - Shielding work areas from drafts or wind will reduce the wind chill in extremely cold environments.

**Contractors shall ensure that Workers:**

- Follow the rest or work break schedules during extreme weather conditions.
- Increase liquid intake to stay hydrated during extreme hot or cold weather conditions.
- Monitor each other for signs of overexposure to thermal extremes.
- All Workers should be aware of signs and symptoms in co-workers.
- Drink plenty of water, fruit juices, and, in hot environments, electrolyte replacement beverages. In cold weather, drink warm non-caffeinated beverages such as cider or herbal teas.
- Train Workers to recognize the signs and symptoms of thermal stress caused by heat-related or cold related conditions.
- PPE for Hot Weather Conditions:
  - Wear light, summer clothing meeting the minimum PPE clothing requirements.
  - If working outside, apply sunscreen with a sun protection factor (SPF) of at least 15.
  - For very hot environments, consider air, water or ice cooled insulated specialty vest worn with normal clothing.
- PPE for Cold Weather Conditions:
  - Wearing appropriate clothing and being aware of how your body is reacting to the cold are important to preventing cold stress.

## 7 Administrative Controls – Abnormal

### 7.1 AED Emergency Response

**Contractors shall ensure that:**

- If a project is legally required to have a first aid room, an AED shall be kept in the room.
- Consider placement of an AED at additional Sites or locations, in cases where:
  - the emergency medical response time for that location is greater than 20 minutes; and/or
  - the project safety plan determines their need.
- All US facilities must maintain a copy of the AED medical prescription on site.
- Only Workers trained in the use of an AED are authorized to use an AED.
- US Facilities must notify all their emergency medical service providers responsible for responding to the facility of the presence and availability of an AED. The notification documentation must be filed.
- AEDs cannot be used inside compressor stations or other facility areas that are considered NEC classified (i.e., NEC classed Group1 Division1 or Group1 Division 2 Hazardous Gas Area).
- AEDs are not intrinsically safe and shall not be stored in Hazardous Areas.
- Each AED shall be mounted on a wall or stored in a cabinet with proper signage and protective casing.
- The AED equipment is inspected monthly. Inspect AEDs in accordance with manufacturer's specifications.



## 7.2 Emergency Equipment

### Inspections

#### **Contractors shall ensure that:**

- Contractor must have a written manual to address emergencies.
- The following safety equipment (if applicable) shall be inspected monthly and documented, using Form HSF-068 Monthly Emergency Equipment Inspection or equivalent:
  - Emergency Eyewash Bottles
  - First Aid Kits
  - Bloodborne Pathogen Kit
  - Burn Kit
  - Automated External Defibrillators
  - Self-Contained Breathing Air (SCBA) Units
- Emergency eyewash bottles
  - Emergency eyewash bottles shall be available where eye hazards are possible and eyewash stations are not readily available.
  - Instructions and the expiration date, if applicable, shall be permanently affixed to the unit. All personal eyewash units shall be inspected and maintained in accordance with the manufacturer's instructions.
  - Emergency eyewash bottles are classified as a secondary (personal) device and are intended to supplement and not replace a 15-min flush capability primary device.
- First Aid Kits
  - Workers shall be trained in the location of first aid kits.
  - First aid kits must be inspected for cleanliness and for an adequate supply of contents. A list of contents should be placed inside the kits. Replace any missing supplies or malfunctioning equipment immediately.
  - The inspection will verify that equipment is in its designated space and/or mounted location, is clearly marked, is free from obstruction to access or visibility, and is in good operating order.
  - Mark the kit inspection tag indicating the date of inspection and all supplies are in the kits and fit for service.
  - The numbers and types of items to be purchased depend on the size of the facility, number of Workers and the specific hazards expected to be encountered.
- Bloodborne Pathogen Kit Protocol
  - Visibly inspect Bloodborne Pathogen Kits for expired dates on supplies, missing supplies/equipment, and inadequate supply quantities. Replace any missing supplies or malfunctioning equipment immediately.
  - Refer to Bloodborne Pathogen Exposure Control Plan for a list of contents in the Bloodborne Pathogen PPE Kit.
- Burn Kit Protocol

- Visibly inspect Burn Kits for expired dates on supplies, missing supplies/equipment, and inadequate supply quantities.
- Replace any missing supplies or malfunctioning equipment immediately.
- Burn kits shall be maintained either close to or in first aid kits, depending on the nature and location of the work in progress.
- Automated External Defibrillators
  - Visibly inspect AEDs at least monthly.
  - Document annual AED inspection on Form HSF-069 Annual AED Inspection or equivalent.
- Perform a monthly 30 second function test on all emergency lighting units.
- Self-Contained Breathing Air (SCBA) Units Protocol
  - Inspect emergency breathing equipment monthly. Check the equipment to ensure:
    - pressure gauges read within the safe limits of pressure.
    - unit face pieces are inspected, marked and tagged.
  - All breathing air equipment service work shall be by an approved vendor.
  - All SCBA cylinders require periodic hydrostatic testing as required by *49 CFR 180.205*. The frequency of the maintenance depends upon the cylinder material.
    - Steel cylinders should be tested every five years. They have an indefinite service life until they fail a hydro test.
    - Aluminum cylinders (not including hoop-wrapped) should be tested every five years. They have an indefinite service life until they fail a hydro test.
    - Hoop-wrapped cylinders should be tested every three years. Hoop-wrapped cylinders have a 15-year service life.
    - Fully wrapped fiberglass cylinders should be tested every three years. They have a 15-year service life.
    - Fully wrapped Kevlar cylinders should be tested every three years. They have a 15-year service life.
    - Fully wrapped carbon fiber cylinders should be tested every five years. They have a 15-year service life.
    - A non-destructive label shall be affixed to the side of the cylinder with the date of manufacturer and the date of subsequent testing.
    - Obtain written documentation from the approved vendor on the types and extent of the inspection and/or repairs completed
- Miscellaneous Emergency Equipment Protocol
  - The following emergency equipment shall be inspected at least monthly to ensure the equipment is operable, always ready for service and in good condition:
    - portable gas metering equipment.
    - emergency use flashlights.
    - burn free fire blankets.

- emergency use tool kits (Brass sledgehammer, 15” Adjustable Wrench, 18” Pipe Wrench, Pressure Gauge with fittings, Thread Tape, Flashlight, Bolt Cutters, Leak Detection Equipment, PPE).
- The inspection frequency for all miscellaneous emergency equipment will be monthly and documented.
- The inspection will verify that equipment is in its designated space and/or mounted location, is clearly marked, is free from obstruction to access or visibility, and is in good operating order.

## 7.3 Emergency Eyewash and Shower Stations

### **Contractors shall ensure that:**

- All Workers who may need the emergency eyewash and shower equipment are trained on their location and use as per appropriate to the project.
- Adequate quantities of eyewash stations are provided based on the type and quantity of chemicals present on the Worksite, and in accordance with the information or directions on the applicable SDSs, plus the Hazard Assessment for that project.
- For self-contained eyewash stations and unsealed portable eyewashes, change the flushing fluids quarterly, or as specified by the manufacturer. If using water, add a preservative to maintain freshness; there are commercial additives that can help prevent freezing and micro-organism build-up.
- At isolated or remote work areas, at least one portable eyewash (squeeze bottle) shall be available anywhere there is a potential Hazard from chemicals.
  - Place squeeze bottles close to the chemical Hazard and protect each bottle from the elements (e.g., prevent freezing).
  - When working with single or small number of batteries with liquid electrolyte (i.e., meter stations), portable eyewash bottles that equal one gallon of solution is appropriate.
  - Where there is low possibility of exposure to electrolyte, portable eyewash bottles that equal a minimum of 1 gallon of solution is appropriate
  - When working with sealed batteries that are non-spilling, portable eyewash is not needed unless visual inspection shows that a case is damaged and contact with internal components is possible.
- During inspection, ensure the eyewash equipment is clean with nozzles protected from airborne contaminants; placed in its designated location. Also ensure sufficient eyewash fluid is available. When inspecting portable eyewashes, ensure the seal is not broken or past the expiry date. If expired, replace immediately or as soon as possible.
- Fixed eyewash stations may be plumbed into the potable water system or have a reservoir. In addition:
  - fixed eyewash stations should be mounted so the discharge nozzles are between 74-91cm (29-36 in.) off the ground.
  - remote fixed eyewash stations that do not have a constant potable water supply shall also have an emergency eyewash station capable of providing approximately 15 minutes of continuous flushing.
  - during each inspection of a fixed eyewash station, flush the line and verify proper operation.

### **Weekly Activation (for plumbed systems)**

- Plumbed emergency showers, eyewashes, eye/face washes, and drench hoses must be activated weekly for a period long enough to verify operation and ensure that flushing fluid is available.
  - This is needed to:

- flush out sediment and microbes, and
  - make certain flushing fluid is available at the shower head and the overall device is in working order.
- Self-contained emergency showers, eyewashes, eye/face washes and drench hoses, must be visually checked monthly (at a minimum) to determine if flushing fluid needs to be changed or supplemented.

### **Annual Inspections**

- All equipment (i.e., emergency showers, eyewashes, eye/face washes, and drench hoses) must be inspected annually to ensure the device conforms to installation requirements. All personal wash units must be inspected annually to assure conformance with having the capacity to deliver immediate flushing fluid without being injurious to the user.
- Annual inspection is necessary to ensure the equipment functions properly and to ensure any changes in the area have not affected the safe use and operation of the equipment.

## **7.4 Emergency Management**

### **Contractors shall ensure that:**

- Communicate this section to all workers and visitors under their supervision
- The Contractor Emergency Response Plan conforms to the requirements set forth by regulatory agencies and emergency response program requirements.
- The Project Site-specific emergency plan is readily available for all locations.
- Emergency evacuation maps, phone contacts and other support documents are posted in prominent locations or available at each site.
- The emergency contact list shall be reviewed quarterly to confirm the accuracy of the emergency response phone numbers and accuracy of individual names.
- Understand and follow the company crisis communication and media response procedures in the event emergency response responsibilities are taken over by company
- Attend emergency response training as required
- Provide feedback following emergency drills or exercises and revise site emergency plan as appropriate
- A current list of Workers trained in first aid and cardiopulmonary resuscitation (CPR) shall be maintained and posted at each site.
- At least one first aid trained Worker shall be assigned to each shift and with each field group working on Company facilities.
- All emergency equipment must be inspected per Emergency Equipment Inspection section.
- First Aid equipment shall be inspected as per the appropriate First Aid Equipment section.
- Fire Extinguishers shall be inspected in accordance with the Fire Extinguishers section.

## 7.5 Fire Extinguishers

### **Contractors shall ensure that:**

- Training to use a fire extinguisher must be given before fire occurs.
- All units with welding machines, oxy/acetylene cutting torches, blowdown trailers, charcoal trailers, and methanol tank trailers (Accident, MD) shall be equipped with at least one 30-lbs (14 kg) extinguisher with either Class BC or ABC-rated extinguishing agent.
- At least two 30-lbs (14 kg) dry chemical fire extinguishers must be on every welding job involving gas handling.
- Workers assigned to “fire watch” duty during welding, cutting or braising operations requiring additional fire protection will wear appropriate PPE as per the hazard assessment:
  - at a minimum, one hand portable fire extinguisher shall be installed on all field motor vehicles, except cars determined to not require a fire extinguisher by Company.
  - at a minimum, one 30-lbs (14 kg) extinguisher with either Class BC or ABC-rated extinguishing agent shall be installed within 7.6 m (25 ft.) of an outside flammable or combustible liquids storage area.
  - extinguishers assigned to permanent locations shall not be taken to the field for standby use.
  - extinguishers for flammable liquids hazards of appreciable depth (Class B) (the depth of a liquid greater than 0.6-cm (¼-in)), such as dip tanks, shall be provided based on one numerical unit of Class B extinguishing potential per square foot of flammable liquid surface of the largest tank hazard within the area.

### **Mounting and Marking Requirements**

- A clearance greater than 10 cm (4 in) must always be maintained between the bottom of the extinguisher and floor.
- Extinguishers exposed to the environment or subject to possible physical damage may be mounted in cabinets or protected with a red vinyl cover.
- Extinguishers mounted on vehicles or trailers shall be accessible, visible and covered with a protective red vinyl cover but should not block the vehicle operator’s view.
- Fire extinguishers that contain hazardous chemicals must be labeled.
- Fire extinguishers that contain compressed gas at greater than 40 psi must be labeled.
- When the manufacturer’s label does not reflect the hazards/contents of the extinguisher, an additional hazard identification label (HMIS, GHS, ANSI, NFPA or similar) may be used to identify the hazards/contents. This label must be affixed to the front of the extinguisher and must not cover/block the manufacturer’s label.

### **Fire Extinguisher Inspection Protocol**

- Inspect the fire extinguishers monthly by trained internal personnel or an approved vendor.
- Document fire extinguisher inspections by using Form HSF-068 Monthly Emergency Equipment Inspection or equivalent.
- During each inspection, check to ensure:

- o the seal tag and other tamper indicators are intact and there are no signs of tampering or that the unit has not been discharged. That pressure gauge or indicator is in the operating range or position.
- o the extinguisher accessibility is not blocked by stored materials or fixed objects.
- o fullness is determined by weighing or hefting for self-expelling-type extinguisher and cartridge operated type extinguishers.
- o examination for obvious physical damage, corrosion, leakage, or clogged nozzles.
- o mark the affixed fire extinguisher tag.

### **Fire Extinguisher Maintenance Protocol**

- Conduct annual fire extinguisher service by an approved vendor to ensure a thorough examination of the basic elements of the fire extinguisher and components.
- Each fire extinguisher shall have a tag or label securely attached that indicates the month and year the maintenance was performed, identifying the name of the person and agency performing the maintenance.
- Each fire extinguisher that has undergone maintenance or re-charged shall have a verification-of-service collar located around the neck of the shell and shall not interfere with the operation of the unit.
  - o Cartridge or Cylinder Operated fire extinguishers are exempt from this requirement.
- All Carbon Dioxide extinguisher type extinguishers shall have an annual conductivity test performed on the hose assembly.
- A non-destructive label with the month, year and name of person performing the test shall be affixed to the hose assembly.
- All fire extinguisher repairs shall be by an approved vendor.
- Obtain written documentation from the approved vendor on the type and extent of inspection and/or repairs completed.
- All stored pressure type fire extinguishers shall be recharged after each use, indicated need after inspection or when maintenance is performed.
- Only properly trained personnel shall re-charge fire extinguishers.

### **Fire Extinguisher Hydrostatic Testing Protocol**

- Fire extinguishers shall be hydrostatically tested as per the required frequencies.
- All fire extinguisher repairs shall be by an approved vendor.
- Obtain written documentation from the approved vendor on the type and extent of inspection and/or repairs completed.
- Document hydrostatic testing on Form HSF-070 Hydrostatic Test Certification (vendor documentation can be used in lieu of Form HSF-070).

### **Contractors shall ensure that Workers:**

- Evacuate fire areas or where there is a danger of the fire spreading.

Evacuate the area and keep others away.

- If a fire involves a flammable or combustible liquid and is in an enclosed vessel, do not begin suppression activities without the ability to control or cut off the fuel supply to the fire.
- Call local emergency services (i.e., fire department) for assistance.

- Activate the building alarm system or notify others of the fire.
- Evacuate the building or area involved in the fire.
- Report fires and fire extinguisher usage immediately to the Company.



## 7.6 First Aid Preparedness

### **Contractors shall ensure that:**

- A current list of Workers trained in first aid and cardiopulmonary resuscitation (CPR) should be maintained at each location.
- Complete the required AED training in addition to the first aid/CPR training requirement, where applicable
- There shall be at least one first aid trained Worker on each shift and with each group working on pipeline facilities.
- Workers shall be trained in the location of first aid kits.
- First aid kits must be inspected monthly for cleanliness and for an adequate supply of contents. Document inspections using Form HSF-068 (Monthly Emergency Equipment Inspections) or equivalent.
- The inspection will verify that equipment is in its designated space and/or mounted location, is clearly marked, is free from obstruction to access or visibility, and is in good operating order.
- A list of contents should be placed inside the kits.
- The Bloodborne Pathogens section requires that additional PPE be maintained either close to or in the first aid kits, depending on the nature and location of the work in progress.
  - Refer to *Bloodborne Pathogen Exposure Control Plan*, for a list of contents in the Bloodborne Pathogen PPE Kit.

## 8 Contractor Safety Management

### 8.1 General Section

Company will communicate safety requirements to all Contractors through ISNetwork and the Company Contractor Safety Specifications as well as project specific scope documentation and pre-job meetings.

#### **Contractors shall ensure that:**

- Hazards are identified, assessed, and controlled.
- Contractors Personnel report all incidents, unsafe conditions, and near misses to the Supervising Company Representative.
- Contractors Personnel operate equipment only with proper training and authorization.
- Contractors Personnel are fit for duty.
- All personnel under the Contractor direction are adequately trained for the services being performed.
- Subcontractors are held to the same standards as the Contractor.
- In the USA, All Medium and High-risk Contractors providing services for UST will need to be registered with Veriforce.
- Contractor's management and supervisors shall provide active assistance and support for the Company in the following ways:
  - Act as the point of contact for communication of work direction from the company.
  - Ensure that all responsibilities of the Contractor, and Contractor Personnel, are performed.
  - Stop all unsafe work immediately.
- Provide Subject Matter Expert (SME) input into Pre-Job Meeting and Site-Specific Orientation materials (as required).
- Ensure attendance of personnel at the Pre-Job Meeting.
- Ensure Contractor Personnel complete orientation requirements prior to work.
- Participate in inspections (as appropriate).
- Organize and provide leadership for required hazard management activities including meetings, JSAs, FLHAs, or equivalent hazard assessment documents.
- Serve as Permit Receiver when leading or working with a group of Workers in each task.
- Provide support to the FAN audit process if completed on their worksite.

### 8.2 Subcontractor Safety Management

- Contractors that will be using Subcontractors must ensure and demonstrate that its Subcontractors meet, comply, or exceed the Company's minimum Safety pre-qualifications criteria.
- The Contractor will document and be able to provide such documentation upon request to the Company as evidence that each Subcontractor has been pre-qualified utilizing the appropriate Company form.
- If a Subcontractor does not meet the Safety pre-qualification requirements, the Contractor will provide documentation to the Company;

- on the appropriate Company form,
  - documenting the areas that they don't meet the criteria, and
  - what the Contractor's corrective actions and or additional safety control measures for managing the Subcontractor for the intended work will be.
- Applicable Company Representative will accept or reject the usage of all Subcontractors.
  - Contractors must provide evidence of training and qualification records to the Company worksite for verification.

### 8.3 Contractor Safety Representatives

- The degree of Contractor-supplied safety representation required will be determined, by Company, in advance of mobilization to site, prior to award and identified in the bid documents.
- Regardless of the degree of Contractor safety representation required, the accountability of Contractor safety performance rests with the Contractor's supervision.
- There are two levels of representation required by Company:
  - Level 1:
    - In the USA, a combined Supervisor or Worker/Safety Representative is required to have the OSHA 510/30 hour (current within the last five years) or approved equivalent training on projects with 15 or less people on site.
  - Level 2:
    - A minimum of one full time Safety Representative with NO OTHER field construction duties is required for any project with 16 or more people on site (or equivalent).
    - In addition, Company may approve other comparable qualifications after a review of the person's combination of training and experience.
    - The Contractor's Safety Representative's resume of qualifications and experience shall be submitted prior to work for approval by the respective Company Safety Coordinator.
    - Additional Contractor Safety Representatives will be required when the workforce exceeds 51 personnel and at every interval of 50 after that. Additional safety personnel may be required as specified in the bid documents. For Mainline construction work one senior safety person, two field safety representatives and one safety administrator for a sizeable pipeline spread.
    - Company reserves the right, at its sole discretion, to change the number of required Contractor Safety Representatives assigned to the Work, accept or reject the suitability of any Contractor Safety Representative, and where making a change or rejecting a Contractor Safety Representative, Company will provide the Contractor with written justification of that decision.
    - The Contractor Safety Representative shall coordinate the requirements of the Contractor's H&S Procedure and the Company Contractor Safety Specifications and advise the Contractor on matters related to OHS.

## 8.4 Incident Reporting and Investigation

- Contractors will immediately report to Company all EHS incidents including work related injuries and illnesses, vehicle, property damage, Near Misses, spills & releases, fires or explosions arising from the Contractor's execution of work.
- Examples include:
  - injuries and illnesses including minor 1st aids
  - damage to company and contractor property
  - fires, explosions, blowouts, or ruptures
  - vehicle incidents including heavy equipment that occur on company property, ROW or projects
  - unauthorized releases to air, land and water
  - security threats
  - work place violence
  - theft
  - all public and landowner complaints,
  - all contact with government agencies and public officials concerning the project or any work activities.
- The Contractor shall provide an initial written report to the Company of its investigation of the incident within 24 hours. Within seven days a final report is required and shall include the following information:
  - Person who reported the incident
  - date reported
  - worksite location
  - date and time the incident occurred
  - indicate the incident type:
    - injury/illness
    - environmental
    - vehicle
    - complaint
    - security
    - near Misses
  - description of the Incident including any immediate actions
  - the final determination of cause of incident and corrective actions
- The Contractor may be asked to participate in the company incident investigation and will implement all agreed to corrective actions.
- The Company can request that all contract personal with direct involvement in the incident be drug and or alcohol tested at the contractor's expense.

## 8.5 Site Safety Management Processes

- Daily shift work requires the following hazard management steps:

- o Tailgate Meeting
  - This is a daily meeting held and led by the Contractor for all workers who will work on a given job.
  - This meeting should include a discussion of anticipated hazards and controls in the work ahead.
  - In certain circumstances, where a pre-work walk through of the worksite is feasible, this meeting may also be used to develop a JSA, discuss an issued SWP, or complete an FLHA.
  - Attendance records must be created for all tailgate meetings.
- o Safe Work Permit (SWP) and/or specialized permit and/or JSA
  - The Contractor People Leader that will participate/directly oversee other workers on a joint task is the Permit Receiver.

### **Contractors shall ensure that Workers:**

- Comply with Company H&S requirements.
- Comply with all applicable legislation.
- Participate in premobilization meetings.
- Follow hazard identification, assessment, and control procedures.
- Report all incidents, unsafe conditions, and near misses.
- Operate equipment only with proper training and authorization.
- Are fit for duty
- Ensure all Workers under the Supplier's direction are adequately trained for the services being performed.
- Ensure Subcontractors are held to the same standards as the Supplier.
- Identify and communicate any specific Supplier procedures to be followed – ID on permit / approval
- Stop all unsafe work immediately.
- Subcontractor Personnel shall:
  - o Comply with Company H&S requirements.
  - o Comply with all applicable legislation.
  - o Participate in premobilization meetings and hazard assessments.
  - o Report all incidents, unsafe conditions, and near misses.
  - o Stop all unsafe work immediately.

### **Pre-Work Activities, Mobilization and/or Kick Off Meetings**

- All Contract Personnel involved in hands on work or management and supervision of hands-on work on the worksite must attend/complete:
  - o A Pre-Job Meeting prior to engaging in work on the site.
  - o Company EHS Orientation
    - This must be completed prior to engaging in work on any Company worksite.
    - Once complete, the Company EHS Orientation is valid for a year for any Company worksite.

- o A Site-specific Orientation
  - This needs to be completed prior to engaging in work at a specific operation or facility for the first time and subsequently if there are significant changes in local conditions since a previous visit that necessitate a new site-specific orientation.
  - Attendance records are kept for any pre-job meetings.
  - The pre-job meeting must include communication of the safety requirements.
- The company people leader may request contractor participation in a safety observation section.
- Contractor Personnel must return SWPs for sign off and SWPs, JSAs, FLHAs (or equivalent) as applicable for archiving purposes.

## 9 Management of Change

### 9.1 General Section

Contractor shall verify that they comply with all of the Company's Management of Change requirements.

## 10 Training and Competency

### 10.1 Competency Assurance

"Competent Person" means one who is capable of identifying existing and predictable hazards in the surroundings or working conditions which are unsanitary, hazardous, or dangerous to workers, and who has authorization to take prompt corrective measures to eliminate them. (CFR 1926.32[f])

Further to the above description, 'competent' means adequately qualified, suitably trained and with sufficient experience to safely perform work without supervision or with only a minimal degree of supervision.

#### **Contractors shall ensure that:**

- Provide Workers with sufficient competency for the work they are assigned.
  - o Contractors must provide evidence for the competency of their Workers.
- Workers must be deemed competent by their Supervisor in an assigned task to be allowed to perform this task independently.
  - o Workers not yet deemed competent may only perform this task under the supervision of another Worker who is deemed competent.
- Supervisors shall assess the H&S competency of Workers under their control. This should include activities such as:
  - o confirming existing qualifications, training, and experience through the onboarding process for new or transferring workers.

- Supervisors should also proactively work with Workers to ensure any necessary qualification or certification for their work does not expire.
  - participating in and/or reviewing spot checks, inspections, or audits of Hazard and Risk Management activities, for example through reviews of JSAs, Safe Work Permits, FLHAs, or other hazard management activities.
  - conducting regular worksite visits and/or inspections to allow for firsthand observation of Worker competency.

**Contractors shall ensure that Workers:**

- Report to their Supervisor any concerns regarding competency issues, especially if they believe they may not be sufficiently qualified or experienced for an assigned task and the hazards it represents or if a required qualification has or is about to expire.

## 10.2 Health and Safety Training

### **Contractors shall ensure that:**

- Workers under their direction are assigned and complete the H&S Training that is:
  - required based on the type of work they do or where they do their work.
- Training is completed before the Worker is exposed to a specific hazard (e.g., asbestos handling course prior to doing this work or confined space entry training prior to participating in a confined space entry).
- All completed HS Training by a Worker must be documented and made available to Company as requested.
- The HS Training Matrix for Contractors Guide outlines the training requirements for specific job roles. Contractors providing one or more job roles will automatically push the minimum training requirements listed on the applicable matrix under the associated job role(s).

### **Contractors shall ensure that Workers:**

- Alert Supervisors if they believe their training on a specific workplace hazard or topic is insufficient for the work they do.

## 10.3 Health and Safety Orientations

### **Contractors shall ensure that:**

- Workers under their direction complete all applicable Company H&S Orientation requirements.
  - this requires ensuring sufficient time for the orientation to be completed prior to beginning work duties.
  - this includes workers new to Contractor or Workers new to a facility or operating area.
- Ensure the following are available and used in individual facilities or operating areas (as applicable) for Visitors and Contractors:
  - GTM General Safety Orientation.
  - Site-specific Safety Orientation.

## 10.4 Safety Observation Program

### **Contractors shall ensure that:**

- Company will be granted access to the site at all times to observe the Work.
- Observation and inspection will be conducted throughout the course of the Project.
- Workers participate in observations program as per company requirements.



# 11 Documents and Records Management

## 11.1 Document Control

### **Contractors shall ensure that:**

- All documents will be maintained in accordance with the Contractor's Record Retention Policy.
- Any Variance to a section, practice or requirement from these Specifications is required to be approved by the appropriate Company Representative.
- A Variance shall always comply with Applicable Legislation.

## 11.2 Records Management

- The Company will audit SWP, JSA, and safety observations for compliance and quality assurance.
  - SWP:
    - All required sections complete
    - Work scope/description contains sufficient detail
    - Is it documented that required PPE has been identified and communicated?
    - It is documented that operational and/or site-specific hazards have been reviewed and discussed
    - Attached permits/documentation/work order # are identified
    - Gas testing/monitoring results are in permissible exposure limit
    - Issuer and receiver have signed
  - JSA:
    - All sections requiring information are filled out
    - Job description aligns with the SWP
    - Job site matches the SWP job site
    - Contractor company identified
    - Each task assigned to an individual
    - Hazards and controls are identified
    - A person (or position) has been identified to put the controls in place for each hazard identified

### **Contractors shall ensure that:**

- An H&S Filing System Directory is established to document the system for orderly documentation in accordance to Contractor's retention requirement.
- Keep documents marked "Confidential" or "Privileged" or defined as such for privacy reasons in secured file separate from other H&S records. These records should be in locked storage cabinet or room with limited access. These documents include but are not limited to:
  - attorney/client privileged information, such as correspondence from the Legal department or outside counsel.

- o attorney work product, such as research or audits done at the direction of the Legal department.
- o confidential information or work products, such as those generated during internal or self-audits.
- o OSHA 300 and 301 Logs.
- o incident investigation documentation which reveals Worker's personal information.

### **Access to Worker Exposure & Medical Records**

- Each Worker has the right to access:
  - o Records which measure or monitor the amount of possible exposure to chemicals or physical agents in the work area.
- Their personal medical records that the contractor has resulting from medical and employment questionnaires, medical examinations, first aid records or any records of medical treatment from on-the-job injuries or illnesses.
- Each analysis using exposure or medical records concerning the Worker's working conditions or workplace.
- Upon written request, the Contractor will provide the information pertaining to exposure, medical records and analysis to the Worker.
- Any Worker who wishes to access exposure or medical records should contact their supervisor for further instructions.
- New Worker shall be informed during orientation and annually thereafter of:
  - o The existence, location and availability of any exposure and medical records.
  - o The person responsible for maintaining and providing access to exposure and medical records.
  - o Each Worker rights of access to exposure and medical records.

## 12 Health and Safety Assurance

### 12.1 Incident Reporting, Investigation and Learning

#### **Contractors shall ensure that:**

- Contractors will immediately report to Company all EHS incidents including work related injuries and illnesses, vehicle, property damage, Near Misses, spills & releases, fires or explosions arising from the Contractor's execution of work.

**Reportable Event:** An event is an unplanned occurrence that interrupts a work activity.

- Reportable events include:
  - People:
    - Injuries or illnesses to Workers or Visitors.
  - Environment:
    - Unauthorized or unplanned releases; or
    - Impacts to air, land, water, or wildlife.
  - Property Damage:
    - Ruptures, fires, or explosions
    - Motor Vehicle, aircraft, or watercraft incidents involving Workers
    - Damage to Company, Contractor, or third-party property; or
    - Theft or vandalism.
  - Regulatory and Other:
    - Government agency visits or contact
    - Permit / license contraventions
    - Unauthorized activity on ROW
    - Landowner / public complaints; or
    - Security Threats.
  - Near Misses involving any of the above.
- The Contractor shall provide an initial written report to the Company of its investigation of the incident within 24 hours. Within seven days a final report is required.
- These guiding principles apply for all investigations conducted on Company Projects:
  - Prevention – Improve the prevention strategies by changing the system
  - Fact finding vs. fault finding – Use collected information collection to uncover the system gaps, not to place blame
  - Confidentiality – Keep confidential information confidential
  - Communication – keep personnel affected by the investigation informed about investigation activities; and

- Systematic Approach – Consistent use of causal analysis methodology improves data collection, analysis and trending, resulting in a more robust system.
- Contractor shall have a process to share incident investigations, lessons learned and corrective action items with workers.

## 12.2 Internal Health and Safety Inspections

### Contractors shall ensure that:

- Company will be granted access to the site at all times to observe the Work.
  - Observation and inspection will be conducted throughout the course of the Project.
- Company H&S inspections can be conducted by any member of the Company; management team, supervisors, operators, technicians, committees, EHS personnel, or consultants for Company.

## 12.3 General Facility Safety Inspection

### Contractors shall ensure that:

- Monthly inspections are completed.
- See that deficiencies reported on the monthly inspections are corrected in a timely manner.
- Formal Inspection – A scheduled inspection of equipment or a work area that will require a written record.
- Informal Inspection – A random visual inspection of equipment or a work area that may require a written record.
- Informal Inspections should be conducted on Work Areas, Life Safety equipment (e.g., Fire Extinguishers).
  - Walking and working surfaces above 1.2 m (4 ft.) must be properly guarded with handrails and toe boards or other barriers.
- Work platforms shall be properly constructed around elevated operating valves.
- All walking and working surface must be free of tripping hazards.
- Eyewash bottles and self-contained emergency eyewash units shall be inspected regularly to ensure they are ready for service.
- Fire protection equipment is formally inspected monthly (by using Form HSF-068 Monthly Emergency Equipment Inspections or equivalent form).

## 12.4 Management of OSHA Regulatory Inspections

Regulatory agencies are authorized to conduct workplace inspections to determine whether employers are complying with standards issued by the agency for safe and healthful workplaces. Workplace inspections are performed by regulatory Compliance Safety and Health Officers who are knowledgeable and experienced in the occupational safety and health field and who are trained in the recognition of safety and health hazards.

OSHA also enforces the General Duty Clause, which requires that every Worker must be provided with a safe and healthful workplace.

The Officer is authorized to review local safety records and reports required by the Occupational Safety & Health Act, such as the OSHA 300 Log for Occupational Injuries and Illnesses.

### **Contractors shall ensure that:**

- The OSHA Compliance Officer is escorted during the inspection.
- Notify Company following an inspection if known or potential violations are denoted by the Officer during the inspection.
- Take detailed notes of the Compliance Officer's activities (i.e., what areas or conditions inspected, what photographs or samples are taken, who he/she talks to). Detailed notes should be taken to produce a comprehensive written account of the visit.
- The "highest ranking" site personnel (or his/her delegate) must accompany the Officer. Arrange for Worker representation, if requested.
- Request to examine the Compliance Officer's credentials. If the inspector does not have an official business card, call his/her office to verify their credentials.
- Write down the Compliance Officer's name, address, and telephone number. Record the date, time of arrival, and departure time.
- Give the Officer your name, address, and telephone number.
- Do not be afraid to ask questions.
  - Ask the compliance officer why he/she chose your job site (worker complaint, etc.).
  - Ask to see a copy of the written complaint, if applicable to the visit.
- Review appropriate Company and Contractor regulations for smoking, carrying of smoking materials, non-intrinsically safe equipment, apparel, etc. for the area he/she will be inspecting.
- Anytime a camera is used inside a Hazardous or Classified area, the area atmosphere must be properly sniffed and monitored.
- Take your own photographs during the inspection or as soon as possible after the Compliance Officer has left.
- Be sure to take several photographs from different angles and distances so all alleged deficiencies/violations are documented.
- Copies of OSHA citations must be posted at or near their respective places of alleged violation.
- A citation issued to a mobile crew must be posted at the location where those workers report to work.
- Citations must be posted until the violation has been resolved or for three working days, whichever is greater.

## 12.5 Internal Self-Assessments

### **Contractors shall ensure that:**

- Company will be granted access to the site at all times to observe the Work.
- Observation and inspection will be conducted throughout the course of the Project.
- Company inspections can be conducted by any member of the Company; management team, supervisors, operators, technicians, committees, EHS personnel, or consultants for Company.

## 12.6 Corrective and Preventive Action

### **Contractors shall ensure that:**

- Report identified H&S program non-conformances to the Company.
- Generate a CAPA from planned or unplanned assurance activity such as:
  - Incident trends (or recurrence) of minor non-conformances
  - Recurring problems with procedures
  - Previous corrective or preventive actions are no longer effective
  - Audit findings
  - Inspection findings
  - Incident Investigation learning
  - Worker concern

# 13 Stakeholder Engagement

## 13.1 Internal Communications

### **Contractors shall ensure that:**

- The following types of work shall have a specific pre-job meeting with Workers involved in the task to discuss the specific Hazards associated with the job:
  - High Voltage Electrical work
  - Serious and Critical lifts
  - Confined Space Entry
  - Excavation and Trenching
  - Work around overhead power lines
  - Open systems work
  - Pigging
  - Tie-ins
  - Specific one-off jobs that are hazardous
- Pre-job meetings must include all work groups involved in job planning and job execution.
- At a minimum, Contractors shall conduct and document:
  - a daily “tailgate” safety meeting; to review work permits and H&S issues associated with the day’s work, and/or in some cases, prior to a specific high-risk task.

- o a weekly (or once per work rotation), formal safety meeting to review all H&S issues; the Contractor shall provide a copy of the written minutes of this meeting to the Company Representative.

## **13.2 Post Incident Leadership Review**

The Post Incident Leadership Review (PLIR) is a Company quality control process whereby the Committee Members review and evaluates the investigation process. All incidents are subject to PLIR review.

## 14 Document Resources

### 14.1 Acronyms

ACRONYM	DESCRIPTION
ACGIH	American Conference of Governmental Hygienists
ACM	Asbestos Containing Material
AED	Automated External Defibrillator
AFFF	Aqueous Film-Forming Foam Concentrate
ALARA	As Low As Reasonably Achievable
ANSI	American National Standards Institute
API	American Petroleum Institute
APR	Air Purifying Respirator
ATPV	Arc Thermal Protection Value
ATV	All-Terrain Vehicle
AWP	Aerial Work Platform
CAPA	Corrective and Preventive Actions
CBT	Computer Based Training
CFR	Code of Federal Regulations
CMV	Commercial Motor Vehicle
CPR	Cardiopulmonary Resuscitation
DOT	Department of Transportation
EAM	Enterprise Asset Management
E&C	Engineering and Construction
EHS	Environmental, Health and Safety
FAE	Functional Abilities Evaluation
FAN	Field Audit Network
FLHA	Field Level Hazard Assessment
FFFP	Film Forming Fluoroprotein Foam
FMCSA	Federal Motor Carrier Safety Administration
FRC	Flame Resistant Clothing
GDL	Governance Documents Library
GHS	Global Harmonized System
GTM	Gas, Transmission & Midstream
HAZCOM	Hazard Communication



ACRONYM	DESCRIPTION
HAZMAT	Hazardous Materials Transportation
HAZOPS	Hazard and Operability Studies
HEPA	High Efficiency Particulate Air
H&S (HS)	Health and Safety
HVSA	High Visibility Safety Apparel
IDLH	Immediately Dangerous to Life or Health Concentrations
IME	Independent Medical Examination
IMS	Integrated Management System
ISN	ISNetworld
LEL	Lower Explosive Limit
LFL	Lower Flammable Limit
LOTO	Lockout/Tagout
MCR	Management Committee Review
MOC	Management of Change
MVI	Motor Vehicle Incident
NEB	National Energy Board
NFPA	National Fire Protection Association
NGL	Natural Gas Liquids
NIOSH	National Institute of Occupational Safety and Health
NOV	Notice of Violation
OEL	Occupational Exposure Limit
OEM	Original Equipment Manufacturers
OFAA	Occupational First Aid Attendant
OHS	Occupational Health and Safety
OPIM	Other Potentially Infectious Material
OQ	Operator Qualification
OSHA	Occupational Health and Safety Administration
PEL	Permissible Exposure Limit
PFAS	Personal Fall Arrest System
PFRS	Personal Fall Restraint System
PFD	Personal Floatation Device
PHA	Process Hazard Analysis

ACRONYM	DESCRIPTION
PHMSA	Pipeline and Hazardous Materials Safety Administration
PIC	Person in Charge
PLHCP	Physician or Other Licensed Health Care Professional
PLM	Pipeline Maintenance
PPE	Personal Protective Equipment
RPE	Respiratory Protective Equipment
ROPS	Roll-Overprotective Structures
ROW	Right-of-Way
RSO	Radiation Safety Officer
SAR	Supplied-Air Respirator
SABA	Supplied Air Breathing Apparatus
SCBA	Self-Contained Breathing Apparatus
SDS	Safety Data Sheet
SME	Subject Matter Expert
SRL	Self-Retracting Lifeline (or Self-Retracting Lanyard)
STEL	Short Term Exposure Limit
SWL	Safe Working Load
SWP	Safe Work Permit
TDG	Transportation of Dangerous Goods
TLV	Threshold Limit Value (ACGIH)
TWA	Time Weighted Average
UAS	Unmanned Aircraft Systems
UAV	Unmanned Aircraft Vehicle
USCG	United States Coast Guard
UTV	Utility Terrain Vehicle
WHMIS	Workplace Hazardous Material Information System
WLL	Working Load Limit
WMP	Waste Management Plan

## 14.2 Definitions

DEFINITION	DESCRIPTION
Acclimatization	The physiological adjustment process that occurs when a healthy worker accustomed to a temperate environment begins to work in a hot or cold environment. These adjustments should take place over a period of days (up to 1-2 weeks), during which time spent may be gradually increased safely.
Air Purifying Respirator (APR)	A respirator with an air purifying filter, cartridge, or canister that removes specific air contaminants by passing ambient air through the air purifying element. <b>In the USA:</b> OSHA 1910.134
All-Terrain Vehicle (ATV)	Also known as a quad, quad bike, or four-wheeler. A vehicle that travels on low-pressure tires, with a seat that is straddled by the operator, along with handlebars for steering control. Any off-road vehicle that does not have factory equipped roll-over protective structures (ROPS) and seatbelts is considered for purposes of this Manual to be an ATV.
Anomaly	A possible deviation in the properties of the pipe or a discontinuity in the material of the pipe, typically reported by non-destructive examination.
Appurtenances	All attachments to piping (e.g., valves, plugs, fittings, stopple fittings, welded fittings, flanges, vents, branch piping, known abandoned Below Grade Facilities, etc.)
Aqueous Film-Forming Foam Concentrate (AFFF)	A substance that is based on fluorinated foam surfactants plus foam stabilizers and usually diluted with water to a 3% or 6% foam solution. The foam solution acts as a barrier that excludes air or oxygen and develops an aqueous film on the fuel surface capable of suppressing the evolution of fuel vapors. The foam solution is suitable for combined use with dry chemicals.
As Low As Reasonably Achievable (ALARA)	The point at which the cost and resources required to reduce risk any further is disproportionate to the benefit gained.
Assigned Protection Factor	The workplace level of respiratory protection that a respirator or class of respirators is expected to provide to employees when the employer implements a continuing, effective respiratory protection section.
Atmospheric Monitoring	Atmospheric Monitoring that continuously monitors atmospheric content and results are typically determined in real-time (e.g., use of a handheld instrument).
Authorized Company Representatives	A qualified Representative authorized by company to supervise a specific task (i.e., LOTO of a machine/equipment to perform maintenance on that machine/equipment)
Authorized Worker	A Qualified Worker authorized by Company to perform a specific task (i.e., LOTO of a machine/equipment to perform maintenance on that machine/equipment).
Automated External Defibrillator (AED)	A device that, once activated, automatically performs an analysis the heart rhythm and, if it detects a problem that may respond to an electrical shock, it permits a shock to be delivered to restore normal heart rhythm.
Below Grade Facility	Refers to existing below grade or underground operating facilities, utilities, structures and supports, such as pipelines, cables, conduits, casings, concrete piles, or concrete foundations.
Benching or Benching System	A method of protecting Workers from cave-ins by excavating the sides of an excavation to form one or a series of horizontal levels or steps, usually with vertical or near vertical surfaces between levels.
Bleed	A drain or a vent.
Blind	A solid plate installed through the cross section of a pipe, usually at a flanged connection. (i.e., Spectacle blinds, Spades, Spacers)

DEFINITION	DESCRIPTION
Blind Flange	A solid plate installed at the end of a pipe on a flange which has been physically disconnected from a piping system at that point.
Block Valve	Gate, plug, or ball valve that blocks flow and isolates pressure to the downstream side when in a closed position. It could be single or double seated and either unidirectional or bidirectional.
Blood	Includes human blood, human blood components, and products made from human blood.
Bloodborne Pathogen	Viruses, bacteria, and other microorganisms in human blood or other potentially infectious materials that can cause disease in persons who are exposed to blood or other potentially infectious materials containing the pathogens. These microorganisms can cause diseases such as Hepatitis B Virus (HBV), Hepatitis C Virus (HCV), Human Immunodeficiency Virus (HIV), and many others.
Bonding	The process of connecting two or more conductive objects together by means of a conductor.
Borehole	A hole in the ground created by drilling, auguring, boring, or other similar operation.
Brace	With reference to scaffolding, a brace is a tie that holds one scaffold member in a fixed position with respect to another member. Brace also means a rigid type of connection holding a scaffold to a building or structure.
Breathing Zone	Volume surrounding a Worker's nose and mouth from which they breathe air over the course of a work period. This zone can be pictured by inscribing a sphere with a radius of about 25 cm (10 in.) centered at the Worker's nose.
Brownfield	Any construction site or activities inside or adjacent, within 3 m (10 ft.), to existing Enbridge facilities. If Hot Work is performed in a Hazardous or Restricted Area, it is considered Brownfield, e.g., construction work inside a facility or beside an exposed operating pipeline that does not have an identified boundary.
Cardiopulmonary Resuscitation (CPR)	The emergency substitution of heart and lung action to restore life to someone who appears not to have breathing capability
Cave-In	The separation of a mass of soil or rock material from the side of an excavation, or the loss of soil from under a trench shield or support system, and its sudden movement into the excavation, either by falling or sliding, in sufficient quantity so that it could entrap, bury, or otherwise injure and immobilize a person.
Ceiling Occupational Exposure Limit	An Exposure Limit which should not be exceeded at any time.
Choppy Seas	Seas forming large waves 1.9-2.7 m (6-9 ft.) high that are irregular and broken with an increased frequency making it difficult to maintain balance on a flat surface.
CO <sub>2</sub> System	A type of fixed fire extinguishing system that releases carbon dioxide from cylinders into an enclosed space. Operation is triggered automatically or manually.
Cold Stress	A general term applied to strain on the body caused by prolonged exposure to cold air or water, or by a short-term exposure to extremely cold air or water.
Cold Work	Any work activity or process that is unlikely to ignite flammable vapors (e.g., does not involve a spark, an open flame, or a hot surface).
Combustible Liquids	Any liquid having a flashpoint at or above 100°F (37.8°C). OSHA 1910.106(a)(18)
Competency	The ability for an individual to demonstrate of both the knowledge and practical skills and training to consistently perform a given task to a pre-determined standard.
Conduction	The transfer of heat between materials that contact each other. Heat passes from the warmer material to the cooler material. For example, a worker's skin can transfer heat to a contacting surface if that surface is cooler, and vice versa.

DEFINITION	DESCRIPTION
Conductor	Cable, bus or any conductive material or piece of electrical equipment.
Confined Space	An enclosed or partially enclosed area that meets all the following: <ul style="list-style-type: none"> <li>• is not designed or intended for continuous Worker occupancy (e.g., tanks, pipes).</li> <li>• has restricted means of entry and exit that may compromise the provision of first aid, evacuation, rescue, or other emergency response (e.g., manholes, electrical vaults, boreholes, pits, sump tanks, vertical and horizontal culverts); and</li> <li>• is large enough so that a Worker's entire body can enter the space</li> </ul>
Confined Space Entry	Occurs when any part of a Worker's body enters a Confined Space.
Contractor	A legal entity with whom Enbridge may enter into an agreement for the provision of labor, materials and/or equipment by the Contractor in the delivery of a specified scope.
Contractor Prequalification Variance Request	Form used to document a contractor's safety prequalification deficiencies, required mitigation plan and management approval to use a deficient contractor with either a yellow or red grade in ISN.
Contractor Personnel	Employees of a Contractor or Subcontractor working under the direct supervision of the Contractor.
Control	A mechanism or process that minimizes the risk of the hazard becoming actual, so it protects people, property, or the environment from the identified hazard.
Convection	The transfer of heat in a moving fluid. Air flowing past the body can cool the body if the air temperature is cool. On the other hand, air that exceeds 35°C (95°F) can increase the heat load on the body.
Corrective Action	A reactive process to address concerns or issues after they have occurred. It assumes that a non-conformance or problem has been identified and has been reported by employees of the organization or by other stakeholders.
Coupler	With reference to scaffolding, a coupler is a device for locking together the component tubes of a tube and coupler scaffold.
De-energized	Disconnected or otherwise isolated from all energy sources and not containing residual or stored energy.
Dismounted	When the operator of an industrial truck is dismounted and within 25 ft. of the truck still in view, the load engaging means shall be fully lowered, controls neutralized, and the brakes set to prevent movement.
Double Block and Bleed	An isolation system that separates a single pressure source by closing two in-line block valves and by opening a drain or vent valve in the line between the two closed block valves.
Downstream	The side of the valve with lower or no pressure.
Enbridge	A generic term used for Enbridge Gas Transmission & Midstream applying to design, construction, commissioning, operations, maintenance and decommissioning, and other legal entities under the control of Gas Transmission & Midstream.
Enbridge Employee	Individuals filling full or part-time positions that have been established for an undefined period of continuous employment. Individuals filling temporary or casual full time or part time positions that are established for a limited, predetermined period, usually less than one year in length.
Enbridge Locations	All Enbridge sites, workplaces, worksites, facilities, terminals, stations, and administrative and project offices.

DEFINITION	DESCRIPTION
Enbridge Operations Representative	A generic term that refers to the Employee responsible for the location (e.g., site supervisor, PLM coordinator/supervisor, technician, terminal supervisor) or designate.
Enbridge Representative	An Enbridge Employee or third-party hire representing Enbridge for specific Contractor work or project.
Enbridge Inspector	An Enbridge Employee or any third-party hire overseeing Enbridge projects on behalf of Enbridge and who is responsible for the inspection of work. May include trade specific inspectors.
Enbridge Workforce	See Workforce.
Enclosed Space	Enclosed or partly enclosed area that is not designed nor intended for frequent and lengthy occupancy, has unrestricted means of entry and exit (e.g., pump shelters and densitometer, instrument and sample buildings), and that may aggravate ordinary job hazards.
Energized	Connected to an energy source or contains residual or stored energy.
Energized Equipment	Conductors and conductive parts of electrical equipment that are not locked out and verified energy free. High-voltage equipment is considered energized until grounded.
Energy Isolation Device	Mechanical device that physically prevents the transmission or release of energy.
Energy Source	Any origin of electrical, mechanical, hydraulic, pneumatic, chemical, thermal or other force.
Ergonomics	Scientific study of people and the work they perform with the goal of minimizing risk of injury/illness through improved workstation design; reducing non-value-added motions and improving Worker moral, productivity, and product quality.
Evaporative Cooling	Takes place when sweat evaporates from the skin. High humidity reduces the rate of evaporation and thus reduces the effectiveness of the body's primary cooling mechanism.
Excavation	Any man-made cut, cavity, trench, or depression in an earth surface, formed by earth removal.
Excavation Area	The area in which any type of excavation is expected to occur. The perimeter of the Excavation Area is to be demarcated with pink and white striped flagging.
Exposure Limit	Workplace standard below which is believed that nearly all normal and healthy Workers may be repeatedly exposed, day after day, for working lifetime without adverse health effects.
Extinguishing Agent	A substance (e.g., dry chemical powder, foam) that interrupts the chemical chain reaction that produces fire by removing heat, removing fuel and/or removing or diluting oxygen (i.e., a substance that can put out a fire).
Facility	Any above or below grade appurtenances (e.g., Pipelines, piping, valves, communication or electrical equipment, conduits, power lines, guide wires, poles, towers, casings, piles, foundations etc.) or the site on which such appurtenances are located (e.g., Pump / Compressor stations, valve sites, pipeline right of way), as the context may require
Fall Hazard	Any potential fall distance of: <ul style="list-style-type: none"> <li>● 1.2 m (4 ft.) or more above a lower level from a <i>Permanent</i> walking/working surface (horizontal and vertical surface) or</li> <li>● 1.8 m (6 ft.) or more above a lower level from a <i>Temporary</i> walking/working surface (includes construction activities) or</li> <li>● Any fall where there is an unusual possibility of injury (e.g., falling through an opening in a work surface)</li> </ul>

DEFINITION	DESCRIPTION
Fall Protection	Protection devices used at elevations that would allow a fall of a short distance (uses an anchorage point).
Fatigue	Weariness or exhaustion due to extended periods of physical and/or mental exertion or illness.
Field Level Hazard Assessment (FLHA)	A form used just prior to the start of work to identify, assess, and control the field-based hazards of the work being performed, and site or environmental conditions that may adversely affect the work (e.g., icy conditions, simultaneous operations, pedestrians).
First aid (US)	First aid refers to medical attention that is usually administered immediately after the injury occurs and at the location where it occurred. It often consists of a one-time, short-term treatment and requires little technology or training to administer. First aid can include cleaning minor cuts, scrapes, or scratches; treating a minor burn; applying bandages and dressings; the use of non-prescription medicine; draining blisters; removing debris from the eyes; massage; and drinking fluids to relieve heat stress. OSHA's revised recordkeeping rule, which went into effect January 1, 2002, does not require first aid cases to be documented. For example: A worker goes to the first-aid room and has a dressing applied to a minor cut by a registered nurse. Although the registered nurse is a health care professional, the employer does not have to report the accident because the worker simply received first aid (OSHA Website).
First aid station	A place, other than a first aid room, at which first aid supplies or equipment is stored.
Flagging Tape	Colored, non-adhesive ribbon used for tagging, roping off, or other marking applications
Flame Resistant Clothing	Clothing made from material with flame resistance properties, i.e., combustion of the clothing is prevented, terminated, or inhibited (slowed). Also known as FRC
Flammable Liquids	<p><b>In the USA:</b> Any liquid having a flashpoint at or below 199.4° F (23°C). Flammable liquids are divided into four categories:</p> <p>CATEGORY 1: Include liquids with a flashpoint &lt;73.4° F (23° C) and a boiling point ≤ 95° F (35° C).</p> <p>CATEGORY 2: include liquids with a flashpoint &lt;73.4° F (23° C) and a boiling point &gt;95° F (35° C).</p> <p>CATEGORY 3: include liquids with a flashpoint ≥73.4° F (23° C) and ≤140° F (60° C). When a Category 3 Liquid with a flash point ≥ 100° F (37.8° C) is heated for use to within 30° F (16.7° C) of its flashpoint, it shall be handled as if it was a Category 3 Liquid with a flashpoint &lt;100° F (37.8° C).</p> <p>Category 4: include liquids with a flashpoint &gt;140° F (60° C) and ≤199.4° F (93° C). When a Category 4 Liquid is heated for use to within 30° F (16.7° C) of its flashpoint, it shall be handled as if it was a Category 3 Liquid with a flashpoint &lt;100° F (37.8° C). When a liquid with a flashpoint &gt;199.4 °F (93 °C) is heated for use to within 30 °F (16.7 °C) of its flashpoint, it shall be handled as if it was a Category 4 flammable liquid</p>
Floor Hole	An opening measuring less than 30.5 cm (12 in) but more than 2.5 cm (1 in) in its least dimension, in any floor, platform, pavement, or yard, through which materials but not individuals may fall, such as a belt hole, pipe opening, or slot opening.
Floor Opening	An opening measuring 30.5 cm (12 in) or more in its least dimension, in any floor, platform, pavement, or yard through which individuals may fall, such as a hatchway, stair or ladder opening, pit, or large manhole.



DEFINITION	DESCRIPTION
Frost Bite	Caused when the fluid surrounding the cells becomes frozen when exposed to extremely low temperatures. The nose, ears, fingers, toes, and cheeks are most vulnerable. Symptoms: loss of color, hardness of tissues, numbness.
Gas	A compressible, formless material that will completely occupy an enclosure irrespective to its quantity. It is a physical state that be changed to a solid or liquid state only by increasing pressure or reducing temperature, or both (e.g., H <sub>2</sub> S).
Greenfield	Areas within the confines of project boundaries that contain no above or below ground facilities.
Ground	In relation to electrical work a ground is a conductor that provides an electrical path for the flow of current into the earth.
Ground Disturbance	<p><b>In the USA:</b> Any work, operation or activity that results in penetration of the earth (e.g., excavating, digging, trenching, plowing, tunneling, auguring, boring, drilling, backfilling, blasting, cultivation, topsoil stripping/leveling, stumping, peat removal, quarrying, fencing, clearing/grading, hydrovac) with the following exceptions:</p> <ul style="list-style-type: none"> <li>● survey staking, line locating and marking,</li> </ul> <p>disturbance less than 30 cm (12 in.) in depth provided the location and original depth of cover for all facilities is known</p> <p><b>I</b></p>
Halon	A material used to extinguish fires, typically used in fixed extinguishing systems to release halon from cylinders into an Enclosed Space. Operation is triggered automatically or manually.
Handrail	A single bar or pipe supported on brackets from a wall or partition, as on a stairway or ramp, to furnish individuals with a handhold in case of tripping.
Hazard	Source or situation with a potential for harm in terms of injury, ill health, damage to property, damage to workplace and environment, or any other definitions as set out by regulations and codes.
Hazard Assessment	Methodology used to identify, assess, and control hazards in order to eliminate or reduce risk to an acceptable level. Includes FLHA, Process Hazard Assessment (or Analysis), HAZOPS, Job Safety Analysis, Facility Hazard Assessments, etc.
Hazardous Area	An area in which there is significant potential for a flammable or toxic atmosphere to be present or develop.
Hazardous Atmosphere	<p>An atmosphere which exposes an individual to a risk of injury, illness, disablement, or death due to one or more of the following causes:</p> <ul style="list-style-type: none"> <li>● A flammable gas/vapor concentration of 10% or greater of its lower explosive limit (LEL)</li> <li>● An atmospheric oxygen concentration below 19.5% or above 23%.</li> <li>● An atmospheric concentration of any substance above the exposure limits established by the governing regulatory body or as indicated on the Safety Data Sheet (SDS)</li> <li>● Any atmosphere which is recognized as Immediately Dangerous to Life and Health (IDLH).</li> </ul>
Hazardous Energy	Any electrical, mechanical, hydraulic, pneumatic, chemical, nuclear or kinetic energy source that if released uncontrolled, could cause injury or loss.



DEFINITION	DESCRIPTION
Hazardous Locations	<p>This any location where an explosive gas atmosphere is present, or may be present, in the air in quantities that require special precautions to control ignition sources. More specifically, this includes:</p> <ul style="list-style-type: none"> <li>Any building or area that is classified as a Class 1, Division 2 or Class 1, Zone 2 or higher or <i>OSHA 29 CFR 1910.307</i> Hazardous (classified) locations (i.e., Class 1, Division 2 or Class 1, Zone 2 or higher).</li> </ul>
Hazardous Material	A material, other than hazardous waste, that because of its quantity, concentration and physical or chemical characteristics, either individually or in combination with other substances is or poses a threat to the environment, humans, or other living organisms.
Hazardous Waste	A substance or material which is no longer used for its original purpose and requires disposal, and by reason of its properties is considered a potential or existing hazard to human health or the environment and therefore, requires special management.
Heat Cramps	Painful cramping of the legs, arms, or stomach muscles, often occurring when relaxing after work. Caused by a loss of salts through sweating. Symptoms: sudden onset; hot, moist skin; normal pulse; normal to slightly high body temperature.
Heat Exhaustion	Extreme fatigue caused by a loss of body fluids and minerals. Symptoms: heavy sweating; intense thirst from dehydration; cool, moist skin (clammy and pale); weak and rapid pulse (120-200); low to normal blood pressure; fatigue; weakness or loss of coordination.
Heat Stress	General term applied to the strain placed on the body when its cooling system must work too hard.
Heat Stroke	A serious medical emergency caused by a complete breakdown of the body's cooling system. Victim's temperature rises to dangerously high levels. Symptoms: high body temperature (above 103° Fahrenheit); absence of sweating (in most cases); hot, red (flushed), dry skin; rapid pulse; difficult breathing; constricted pupils; high blood pressure; headache or dizziness; confusion or delirium; bizarre behavior; weakness; nausea or vomiting. Advanced symptoms: seizure or convulsions; collapse; loss of consciousness; deep coma; no detectable pulse; body temperature over 108 °F (Fahrenheit).
Hierarchy of Controls	<p>A system used to implement controls based on the level of effectiveness to minimize or eliminate exposure to hazards. Elimination of the hazard or risk is the most effective form of control.</p> <ol style="list-style-type: none"> <li>Elimination</li> <li>Substitution</li> <li>Engineering</li> <li>Administrative (e.g., work practices)</li> <li>Personal Protective Equipment</li> </ol>
High / Medium Risk Contractors	Determined on the Contractor Risk Classification List.
High Efficiency Particulate Air (HEPA) Filter	A filter that is at least 99.97% efficient in removing mono-disperse particles of 0.3 micrometers in diameter. Including filters used for personal respiratory protection, vacuum cleaners, or heating/ventilation/air conditioning systems.
High Voltage	<b>In the USA:</b> 600 Volts <b>I</b>
High Winds	Sustained winds greater than 50 km/hr. (30 mph).
Hot Work	Any process that can be a source of ignition when flammable material is present or can be a fire hazard regardless of the presence of flammable material.

DEFINITION	DESCRIPTION
Hydrovac	The use of pressurized water or air to loosen soil, then the use of a vacuum to extract the loosened soil. This includes all activities performed by a vacuum truck including but not limited to “hydrovac,” “shot gunning,” “day lighting,” “potholing,” “water washing.” It is sometimes referred to as vacuum excavation.
Hypothermia	Lowering of the body’s core temperature caused by prolonged exposure to low temperatures. As the body temperature gets lower, the metabolic functions of the body slow down, causing shivering, incoherence, memory lapse, and drowsiness. Severe hypothermia may lead to death.
Immediately Dangerous to Life or Health Concentrations (IDLH)	An atmospheric concentration of any toxic, corrosive or asphyxiant substance that poses an immediate threat to life or would cause irreversible or delayed adverse health effects or would interfere with an individual's ability to escape from a dangerous/hazardous atmosphere.
Imminent Hazard	Any hazard, condition or activity that could reasonably be expected to be an imminent or serious threat to the life or health of a person exposed to it before the hazard or condition can be corrected or the activity altered.
Incident	An unplanned activity or situation that resulted in or had the potential to result in, an adverse or undesirable environmental, health, safety, or business consequence.
ISNetworld (ISN)	A contractor informational database used to manage, evaluate, verify and standardize contractor safety prequalification information. Contractors upload safety program information, statistical data, and records of compliance with regulatory requirements for review and verification into the ISNetworld database.
Isolated	Sources of energy have been disconnected or controlled.
Isolation	Pre-defined system for securing one or more isolation points to stop or prevent flow of energy.
Isolation Point	Location where the energy isolation device is installed.
Journey Management	A plan and systematic strategy to reduce transportation-related risks within a company’s operations. Trip management is one component of journey management.
Lifting Device	Supplementary device used to handle certain types of loads (i.e., hook, sling, clevis). The weight of lifting devices is considered part of the rated load.
Load	Total weight of an object plus the weight of the rigging equipment.
Lock	a device used to secure an isolation device in the appropriate position to prevent accidental energizing or startup of the machine/equipment.
Lockout	Physical placement of a lock on an energy-isolating device to ensure the equipment being controlled cannot be Energized until the lock is removed.
Low Risk Contractors	as determined on the Contractor Risk Classification List.
Low Voltage	<b>In the USA:</b> 30 to 600 Volts
Lower Explosive Limit (LEL)	The lowest concentration (percentage) of a gas or a vapor in air capable of producing a flash of fire in presence of an ignition source (arc, flame, heat). At a concentration in air below the LEL there is not enough fuel to continue an explosion. Concentrations lower than the LEL are "too lean" to explode but may still burn with great heat and light. Exact values can be found on product’s SDS. Also referred to as LFL (Lower Flammable Limit).
Lower Flammable Limit (LFL)	See Lower Explosive Limit (LEL).

DEFINITION	DESCRIPTION
Management of Change (MOC)	A systematic approach to ensuring proposed changes are rigorously assessed for risk and impact, and that change is effectively managed prior to implementation to achieve targeted results
Medical treatment facility	means a hospital, medical clinic or physician's office, at which emergency medical treatment can be dispensed.
Modified Work	Any work-related injury or illness that prevents a Worker's ability to perform their regularly assigned duties, but are medically able to perform alternate, modified or restricted work.
Near Miss	Any event, which under slightly different circumstances, may have resulted in injury or ill health of people, or damage or loss to property, plant, materials or the environment.
Negative Pressure Regulator	A regulator in which the air pressure inside the facepiece is negative during inhalation with respect to the ambient air pressure outside the respirator.
Non-classified Area	An area where flammable or toxic atmosphere is unlikely to develop or exist.
Non-Permit Required Confined Space	A Confined Space that has been checked, inspected and its atmosphere has been monitored and is being continuously monitored to ensure it does not have (or does not have the potential to have) any of the characteristics required to be classified as a permit required Confined Space.
One-Call (First Call)	A One-Call is a notice given to a local One-Call Centre/authority that an excavation will be taking place. Legislation varies by location, but anyone performing an excavation is typically legally obligated to contact the One-Call Centre/authority 2-5 days prior to commencing excavation. The One-Call Centre/authority notifies its members (owner/operators) that their Below Grade Facilities are near the excavation.
One-Call Member	A Facility Owner/ operator who subscribes to the One-Call Centre/authority and is notified when a One-Call is placed if the Excavation Area is near the members Below Grade Facilities.
Open System	Any part of the pipeline system open to the atmosphere that has been isolated.
Operations Employee	Generic term used to refer to all Operations employees, including technicians.
Operations Management	Regional managers, team leaders, and designates.
Operator Qualification (OQ)	A set of programs that qualify an operator for specific tasks. e.g.: Technical training (e.g., occupational skills training, equipment specific training, etc.)
Overseeing	To watch over, observe and manage Enbridge requirements of the Contractor.
Oxygen Deficient Atmosphere	An atmosphere with oxygen content below 19.5% by volume.
Partition	A portable safety screen complete with stand-alone lightweight frame that is used to enclose Hot Work activities (available in singular or multi-panel arrangement of various widths and heights).
People Leader	Anyone who has direct report(s).
Permissible Exposure Limit (PEL)	An occupational health standard instituted to safeguard Workers against exposure to toxic material in the workplace
Permit Required Confined Space	<p>A Confined Space that is hazardous or that may become hazardous due to one or more of the following:</p> <ul style="list-style-type: none"> <li>• work activity would cause adverse health effects (e.g., fiber glassing, abrasive blasting, welding),</li> <li>• contains or has the potential to contain a hazardous atmosphere (e.g., H<sub>2</sub>S, LEL or O<sub>2</sub>),</li> </ul>

DEFINITION	DESCRIPTION
	<ul style="list-style-type: none"> <li>contains a material that has the potential for drowning or suffocating a Worker (e.g., liquid),</li> <li>has an internal configuration such that a Worker could become trapped or asphyxiated, and/or contains any other safety or health hazard which is recognized as immediately dangerous to life and health (IDLH) (e.g., energy sources, visibility).</li> </ul>
Person In Charge (PIC) / Operating Authority	Responsible for oversight of activities including but not limited to: Confined Space, LOTO, Isolation, Hot Work, and Critical Lifts. With respects to LOTO, the PIC implements and coordinates the overall lockout of hazardous energy sources for machines/equipment to be maintained. (For group lockout, one PIC shall be designated)
Personal Fall Arrest System (PFAS)	Commonly used PFAS include a body harness, lanyard, and anchor point. Fall Arrest relates to <u>stopping</u> a falling worker before striking a lower level/object.
Personal Fall Restraint System (PFRS)	Commonly used PFRS include a body harness, self-retracting lifeline (SRL) or lanyard, and anchor point. Fall Restraint relates to <u>preventing</u> a fall from occurring in the first place.
Platform	A working space for individuals, elevated above the surrounding floor or ground, such as a balcony or platform for the operation of machinery and equipment.
Positively Identify	To visually locate (daylight) the location, depth and size of Below Grade Facility by using either water washing (hydrovac, as an example) or hand digging. This includes elevation or alignment changes that can alter the depth/direction of the pipe (i.e., 90 and 45-degree elbows), fittings, plugs, weldolets, flanges, branch piping, known abandoned facilities, etc.
Pressure Demand Regulator	A positive pressure regulator that admits breathing air to the facepiece when the positive pressure is reduced inside the facepiece by inhalation.
Preventive Action	A proactive process and is initiated to stop a potential problem from occurring or from becoming too severe. Preventive action focuses on identifying negative trends and addressing them before they become significant.
Process Hazard Analysis (PHA)	A detailed examination of a process, equipment or facility design that will assist in identifying hazards and required controls. PHA's are used to evaluate hazards in new designs as well as existing facilities.
Qualified	One who, by possession of a recognized degree, certificate, or professional standing, or who by knowledge, training, and experience, has successfully demonstrated his ability to solve or resolve problems relating to the subject matter, the work, or the project
Qualified Electrical Worker	A Worker who has the knowledge, training, and experience to perform electrical work, including Enbridge electricians, contract journeymen electricians, and contractor electricians working under the direct supervision of contract journeymen electricians.
Radiation	Emission of atomic particles or electromagnetic energy from the nucleus of an atom. This emission is caused by the natural decay of radioisotopes (nuclides) and/or x-rays produced by electrical means from portable or fixed static equipment.
Radiation Safety Officer (RSO)	Designated individual who has received specific radiation safety training and who oversees the operations of the radiation safety program.
Radiation Source	Apparatus or material emitting or capable of emitting ionizing radiation.
Remote Worksite (CAN)	A worksite that has road access, is located on an existing Facility / Right-Of-Way (ROW) or has a defined site footprint with ambulance response time of more than two hours.

DEFINITION	DESCRIPTION
Restricted Area	Any area in which there is a potential for a flammable or toxic atmosphere to develop, or that may contain other hazards.
Risk	The combination of the likelihood and consequence of an unexpected positive or negative deviation from the expected outcome.
Roll Over Protective Structures (ROPS)	Engineered protection structures on heavy equipment and All-Terrain Vehicles meant to protect the operator and passenger(s) in the event the equipment rolls over.
Root Cause	Include personal factors and job factors from which substandard acts and conditions originate. These factors are the reasons why the immediate/direct causes exist, and the identification of such factors permits meaningful management control. Root Causes are often also referred to as basic causes or indirect causes.
Runway	A passageway for individuals elevated above the surrounding floor or ground level, such as a foot-walk along shafting or a walkway between buildings.
Safe Work Permit (SWP)	An agreement between the Permit Issuer and Receiver that is used to authorize work for a specific time and location and to ensure a safe area of work for the working group.
Safe Working Load	Commonly understood to be the load which a given lifting device or lifting arrangement can safely lift, suspend or lower
Safety Data Sheet (SDS)	A Safety Data Sheet (SDS), previously called a Material Safety Data Sheet (MSDS), is a document that provides information on the properties of hazardous chemicals and how they affect H&S in the workplace.
Safety Watch	A qualified Worker responsible for monitoring work activities to ensure safe work practices are followed, to identify hazards, to alert Workers of hazardous conditions and to initiate emergency response procedures.
Self-Contained Breathing Apparatus (SCBA)	A respirator that has a portable supply of breathing air and is independent of the ambient atmosphere. The breathing air source is designed to be carried by the user.
Severity Rating	The rating as determined using the Enbridge Actual & Potential Incident Severity Guidance Document from ESOR and the current Severity Matrix.
Shall	Indicates mandatory; no deviation is permitted without authorization from the appropriate vice-president
Shoring	Shoring is a temporary installation, which “shores” up or supports trench or excavation walls to prevent movement of soil, underground utilities, roadways, and foundations.
Short Term Exposure Limit (STEL)	A 15-minute Time Weighted Average (TWA) exposure limit that should not be exceeded at any time during a workday even if the overall 8-hour TWA is within limits, and it should not occur more than 4 times per day. There should be at least 1 hour between successive exposures.
Should	Used where an action is recommended.
Signaler/Spotter	A competent Worker that looks for, locates, guides, signals, and reports hazards – as well as one who will stop unsafe activities – in relation to movement of vehicles and heavy equipment. This person shall have the ability to clearly communicate to the Workers under their care and site supervision as required.
Single Block and Bleed	An isolation system utilizing one block valve to separate one pressure source with a bleed downstream of the sealing surface.
Site	See Worksite.
Site Supervisor	See Enbridge Operations Representative.
Sloping	A method of preventing cave-ins of excavation and trench walls by cutting them back on an incline away from the excavation or trench. The angle of incline shall vary with

DEFINITION	DESCRIPTION
	differences in such factors as the soil type, environmental conditions of exposure, and application of soil overloads.
Softener	Material used to prevent loads from slipping and to protect cable or rope from damage.
Spoil Pile	A pile of material that was removed from an excavation, trench, or borehole.
Standard	Approved Enbridge practice.
Standard Precaution	Administrative controls based on the premise that all blood and bodily fluids are considered infectious and are treated as such (also known as universal precautions).
Standard Railing	A vertical barrier erected along exposed edges of a floor opening, wall opening, ramp, platform, or runway to prevent falls of individuals.
Standard Strength and Construction Railing	Any construction of railings, covers, or other guards that meets the requirements of <i>29 CFR 1910.23</i> .
Static Electricity	An accumulation of electric charge on an insulated body.
Station Site	Fenced-in pump stations, valve stations, terminals, etc.
Stop Work Authority	<p>The special authority or power vested in a designated person on a worksite to stop and subsequently restart some or all work activities on that worksite. In the context of a GTM worksite, this authority automatically rests with the Safe Work Permit Issuer (who has a formalized process for initiating, suspending, restarting, or cancelling work activities) and the Person in Charge.</p> <p>This authority may be exercise when a hazard arises that requires further controls before work continues or when a work activity is not being conducted in accordance with the Safe Work Permit, the GTM Health and Safety Manual or GTM Construction Safety Manual.</p> <p>The Stop Work Authority is not to be confused with the general right to stop work by any person on a worksite in response to a hazard arising. Any worker may stop their work as per the Stop Work, Imminent Hazard, and Right to Refuse Unsafe Work process.</p>
Subcontractor	Any person, firm or corporation contracting with the Contractor to perform part of the work and shall include partners and associates in a joint venture so contracting with the Contractor.
Subject Matter Expert (SME)	A person with experience or expertise in a specific aspect or topic. i.e. a Process Safety Engineer
Supplied-Air Respirator (SAR) or Supplied Air Breathing Apparatus (SABA)	An atmosphere-supplying respirator for which the source of breathing air is not designed to be carried by the user.
Supplier	A generic term referring to Contractor(s) and Vendor(s) cumulatively.
Supplier / Contractor Safety Variance / Exclusion	Form used to document a Suppliers safety prequalification deficiencies, required mitigation plan and Management approval to use a deficient Supplier with either a Yellow or Red grade in ISN.
Tagout	Placement of a perforated tag on an energy-isolating device to indicate that the device and machine/equipment being controlled shall not be operated until the tag is removed.



DEFINITION	DESCRIPTION
Threshold Limit Value (TLV)	Occupational exposure limit set by the American Conference of Governmental Industrial Hygienists (ACGIH) under which it is believed that nearly all Workers may be repeatedly exposed, day after day, over a working lifetime, without adverse health effects.
Tight Fitting Respirator	A respirator that is designed to form a complete seal with the face or neck.
Time Weighted Average (TWA) Exposure Limit	The average exposure a contaminant for an individual over a given working period determined by sampling at given times during the period. Unless otherwise mentioned, TWA is the concentration of contaminants measured over an 8-hour period.
Toeboard	A vertical barrier at floor level erected along exposed edges of a floor opening, wall opening, platform, runway, or ramp to prevent falls of materials.
Trench	An elongated excavated area of ground whose depth exceeds its width at the bottom.
Trench Box	A self-contained steel structure placed in an excavation that is designed to withstand soil pressures and protect the Workers against cave-ins.
Trench Foot	A condition caused by long, continuous exposure to above freezing cold temperatures, while in contact with dampness or water. The affliction is characterized by swelling, tingling, itching, and severe pain, followed by tissue death, and ulceration.
Unattended	A powered industrial truck is unattended when the operator is 25 ft. or more away from the vehicle which remains in view, or whenever the operator leaves the vehicle, and it is not in view.
Unmanned Aerial Vehicle (UAV)	A UAV is simply the aircraft or drone itself.
Upstream	The side of the valve that maintains pressure.
Utility Terrain Vehicle (UTV)	Also known as a side by side. For purposes of this Manual is defined as a small 2-person or up to 6-person four-wheel drive, off-road vehicle, factory-equipped with roll-over protective structures (ROPS) and seatbelts. This includes Recreational Off-Highway Vehicles (ROHVs) and Multipurpose Off-Highway Utility Vehicle (MOHUV), as defined by ANSI Off-Highway Utility Vehicle (MOHUV), as defined by ANSI.
Vapor	Gaseous form of substances that are normally in liquid or solid state; it can be changed to solid or liquid by increasing pressure, decreasing temperature, or both. Evaporation may create vapors.
Vendor	Any person, firm or corporation with whom Enbridge may enter into an agreement for the provision of engineered and/or fabricated equipment.
Verification	Confirmation that the machine/equipment is in a zero-energy state.
Visitor	Any Enbridge or non-Enbridge individual that is not performing any assigned work activity on an Enbridge worksite (i.e. facility, right-of-way, or construction site). An example of a visitor is any individual or group on a tour of an Enbridge worksite.
Wall Hole	An opening less than 76 cm (30 in) but more than 2.5 cm (1 in) high, of unrestricted width, in any wall or partition; such as a ventilation hole or drainage scupper.
Wall opening	An opening at least 76 cm (30 in) high and 46 cm (18 in) wide, in any wall or partition, through which individuals may fall; such as a yard-arm doorway or chute opening.
Waste Management Plan	A written document designed to assist Enbridge personnel and contractors with the identification of appropriate waste management practices for each waste type generated by Enbridge operations.
Wilderness Worksite	A worksite that does not have road access, is not located on an existing Facility/ Right-Of-Way (ROW) or does not have a defined site footprint. (e.g., Survey, Environmental Studies, Geotechnical/Geophysical).

DEFINITION	DESCRIPTION
Work Authorization Issuer	An Enbridge Operations Representative who shall be familiar with the operational and/or site-specific hazards covered by the Work Authorization being issued.
Work Load	<p>Level of heat produced by the body based on type of work being done. Work load may be divided into three categories based on type of operation or by estimating the metabolic rate of the workers in kilocalories per hour (kcal/hr.) burned by the body. The three categories are:</p> <p>Light work (up to 200 kcal/hr.), for example: sitting or standing to control machines, performing light hand or arm work.</p> <p>Moderate work (200-350 kcal/hr.), for example: walking about with moderate lifting and pushing.</p> <p>Heavy work (350-500 kcal/hr.), for example: pick and shovel work.</p>
Work Restraint	Protection devices used at elevations that will not permit a Worker to travel beyond a certain point.
Workers	Term used to refer to Employees and Contractors cumulatively.
Workplace	See Worksite.
Worksite	Entire work area required for the work, including station property, right-of-way, temporary working space, and all right-of-way storage areas as required by Enbridge.
Zero Energy	Pertaining to the control of hazardous energy (LOTO) Zero Energy is when all energy and potential or stored energy is removed or controlled and verified.



### 14.3 List of Tables

Table 1: Installing Bonding Cables .....	37
Table 2: Minimum Entry Conditions and Requirements for Confined Space Entry Procedures .....	45
Table 4: Minimum Clearance Distances (US).....	56
Table 6: Rated Capacity (Working Load Limit), for Alloy Steel Chain Slings (in lbs.) .....	58
Table 7: Minimum Allowable Chain Size at Any Point of Link.....	58
Table 8: Limited Approach Boundaries .....	66
Table 9: Approach Boundaries to Energized Electrical Conductors or Circuit Parts for Shock Protection, Direct-Current Voltage Systems .....	66
Table 10: Sloping Requirements Based on Soil Types.....	70
Table 11: Minimum Distance for Materials from Edge of Excavation .....	73
Table 12: Maximum Allowable Size for Containers and Portable Tanks .....	82
Table 13: Types of Monitoring Instruments.....	97
Table 14: Portable Gas Monitor Alarm Set Points .....	98
Table 15: Levels of Isolation Methods .....	117
Table 16: Minimum Section Overlap on Two-section Extension Ladders.....	120
Table 17: Minimum Requirements – Eye and Face Protection.....	138
Table 18: Minimum Requirements for Hand Protection .....	140
Table 19: Requirements for Protective Clothing .....	143
Table 20: Acceptable Flame-Resistant Clothing Styles .....	145
Table 21: Voltage-Rated Rubber Gloves .....	147
Table 22: Minimum Scaffold Distances to Energized Power Lines.....	170
Table 23: Scaffold Planking Material Requirements .....	171

## 14.4 List of Figures

Figure 1: Lifesaving Rules .....	9
Figure 2: Stop Work Authority.....	13
Figure 3: Example of Permit Required Confined Space Signage Requirements.....	47
Figure 4: Example of Non-Permit Confined Space Signage Requirements .....	48
Figure 5: Area Classification Legend .....	101
Figure 6: Arc Flash PPE Guide.....	148